

B

B

RACORES AUTOMÁTICOS
RACORES CON FUNCIONES NEUMÁTICAS
RACORES ROSCADOS
VÁLVULAS DE ESFERA
ELECTROVÁLVULAS
ACCESORIOS
TUBERÍAS

Push-in fittings
Function fittings
Threaded fittings
Ball valves
Solenoid valves
Accessories
Tubes

RACORES AUTOMÁTICOS - push-in fittings	Pág. B1-B44
RACORES AUTOMÁTICOS TERMOPLÁSTICO - Plastic push-in fittings	Pág. B1-B19
RACORES AUTOMÁTICOS EN LATÓN NIQUELADO - Brass push-in fittings	Pág. B20-B25
RACORES AUTOMÁTICOS INOX AISI 316 - INOX AISI 316 push-in fittings	Pág. B26-B31
RACORES ALIMENTARIOS DE ALTA PRESTACIONES-metrica - Plastic high performance push-in fittings-metric	Pág. B32-B36
RACORES ALIMENTARIOS DE ALTA PRESTACIONES-pulgadas - Plastic high performance push-in fittings-inches	Pág. B37-B41
RACORES AUTOMÁTICOS PARA ENGRASE CENTRALIZADO - Centralized lubrication push-in fittings	Pág. B42-B43
RACORES CON FUNCIONES NEUMÁTICAS - Function fittings	Pág. B45-B78
REGULADORES DE CAUDAL TIPO BANJO - Banjo flow regulators	Pág. B46-B53
REGULADORES DE CAUDAL CON VÁLVULA DE BLOQUEO PILOTADA - Flow regulators with pilot check valve	Pág. B54-B57
REGULADORES DE CAUDAL EN LINEA - Flat flow regulators	Pág. B58-B62
VÁLVULAS DE ESCAPE RÁPIDO - Quick exhaust valve	Pág. B63
VÁLVULAS MANUALES 3/2 VÍAS - Hand valves 3/2 lines	Pág. B64-B67
VÁLVULAS DE SEGURIDAD TARADAS - Safety valves	Pág. B68
VÁLVULAS CON INTERRUPTOR NEUMÁTICO - Pneumatic valve switch	Pág. B69
MANÓMETRO EN LÍNEA - Pressure gauge	Pág. B70-B71
VÁLVULAS DE CORREDERA - Slide valve	Pág. B72
VÁLVULAS DE CORREDERA CON BLOQUEO DE SEGURIDAD - Slide valve with security block	Pág. B73
VÁLVULAS DE BLOQUEO - Stop fittings	Pág. B74-B75
VÁLVULAS ANTIRRETORNO - Check valve	Pág. B76-B77
RACORES ROSCADOS - Threaded fittings	Pág. B79-B132
RACORES DE RESINA ACETAL - Acetal resin push-on fittings	Pág. B80-B81
RACORES DE POLIPROPILENO - Polypropylene resin push-on fittings	Pág. B82-B87
RACORES DE PVDF - PVDF push-on fittings	Pág. B88-B91
RACORES CON TUERCA MOLETEADA EN LATÓN NIQUELADO - Brass push-on fittings	Pág. B92-B97
RACORES CON TUERCA MOLETEADA EN ACERO INOXIDABLE AISI 316 - Push-on fittings INOX AISI 316	Pág. B98-B101
RACORES CON BICONO EN LATÓN NIQUELADO - Brass compression fittings	Pág. B102-B105
RACORES CON BICONO EN ACERO INOX AISI 316-DIN2353 - Compression fittings INOX AISI 316-DIN 2353	Pág. B106-B109
ACCESORIOS ROSCADOS EN LATÓN NIQUELADO - Brass standard fittings	Pág. B110-B119
ACCESORIOS ROSCADOS EN INOX AISI-303 Y AISI-316 - Standard fittings INOX AISI-303 and AISI-316	Pág. B120-B121
ACCESORIOS ROSCADOS EN INOX AISI-316 MICROFUSIÓN - Standard fittings INOX AISI-316 microfusion	Pág. B122-B129
DISTRIBUIDORES DE ALUMINIO - Distribution manifolds aluminium	Pág. B130-B131
VÁLVULAS DE ESFERA - Ball valves	Pág. B133-B142
MICROVÁLVULAS DE ESFERA EN LATÓN - Brass micro ball valves	Pág. B134
MINIVÁLVULAS DE ESFERA EN LATÓN - Brass mini ball valves	Pág. B135
VÁLVULAS DE ESFERA EN LATÓN - Brass ball valves	Pág. B136
VÁLVULAS DE ESFERA EN LATÓN-MANDO DE MARIPOSA - Brass ball valves-butterfly handle	Pág. B137
GRIFO DE ESFERA EN LATÓN PARA MANGUERA - Ball bibcock with hose connector	Pág. B138
MINIVÁLVULAS DE ESFERA EN INOX AISI 316 - Mini ball valves INOX AISI 316	Pág. B139
VÁLVULAS DE ESFERA EN INOX AISI 316 - Ball valves INOX AISI 316	Pág. B140
VÁLVULAS DE ESFERA EN INOX AISI 316 MICROFUSIÓN - Ball valves INOX AISI 316 microfusion	Pág. B141
ELECTROVÁLVULAS INOX AISI 316L - Solenoid valves INOX AISI 316L	Pág. B143-B146
ELECTROVÁLVULAS INOX AISI 316L - Solenoid valves INOX AISI 316L	Pág. B144-B146

ACCESORIOS - Accessories	Pág. B147-B174
SILENCIADORES - Silencers	Pág. B148-B151
DEPÓSITOS - Tanks	Pág. B152-B155
ELEMENTOS DE ESTANQUEIDAD PARA ROSCAS - Sealing for threaded elements	Pág. B156-B161
ABRAZADERAS - Clamps	Pág. B162-B163
RACORES FIJOS Y GIRATORIOS PARA MANGUERA - Joints for spiral hoses	Pág. B164
ACCESORIOS PARA TUBOS - Accessories for tubes	Pág. B165
MANÓMETROS Y VACUÓMETROS - Pressure gauges	Pág. B166-B168
PISTOLAS SOPLADO, INFLADORES NEUMÁTICOS Y KIT SOPLADO - Air guns, tyre-inflating guns and gun kit	Pág. B169-B173
TUBERÍAS - Tubes	Pág. B175-B196
TUBERÍA DE POLIURETANO - Polyurethane tube	Pág. B176
ESPIRAL DE POLIURETANO - Polyurethane coiled tube	Pág. B177
TUBERÍA DE POLIAMIDA - Polyamide tube	Pág. B178
ESPIRAL DE POLIAMIDA - Polyamide coiled tube	Pág. B179
TUBERÍA DE CAUCHO - Rubber hose	Pág. B180
TUBERÍA DE PVC PARA AIRE AZUL - Flexible hose in PVC Blue	Pág. B180
TUBERÍA DE PVC PARA AIRE NEGRO - Flexible hose in PVC Black	Pág. B181
TUBERÍA DE CAUCHO REFORZADA - Rubber reinforced hose	Pág. B181
TUBERÍA BITUBO DE POLIURETANO - Polyurethane twin hose	Pág. B182
TUBERÍA CALIBRADA DE PTFE - PTFE calibrated tube	Pág. B183
TUBERÍA DE POLIETILENO - Polyethylene tube	Pág. B184
TUBERÍA FLEXIBLE PARA COMBUSTIBLES - Hoses for fuels	Pág. B185
TUBERÍA PARA LIMPIEZA CON AGUA CALIENTE USO ALIMENTARIO - Hot water cleaning hose food aproved	Pág. B185
TUBERÍA TRANSPARENTE MALLADA - Transparent flexible PVC hose	Pág. B186
TUBERÍA POLIURETANO/PVC REFUERZO TEXTIL - Flexible hose PU/PVC	Pág. B186
TUBERÍA DE POLIURETANO ANTIABRASIVO - Antiabrasive polyurethane hose	Pág. B187
TUBERÍA ANTIESTÁTICA - Antistatic tube	Pág. B188
TUBERÍA AUTOAJUSTABLE - Self fastening tube	Pág. B189
TUBERÍA AUTOAJUSTABLE PARA ROBÓTICA - Self fastening tube for robotics	Pág. B190
RACORES PARA TUBERÍA AUTOAJUSTABLE - Stell barb connectors for self fastening tubes	Pág. B190-B191
TUBERÍA DE POLIURETANO ANTICHISPAS DIN 5510-2 - Antisparkii polyurethane tube DIN 5510-2	Pág. B192
ENROLLADORES AUTOMÁTICOS - Automatic reels	Pág. B193
ENROLLADORES DE MANGUERA - Hose reels	Pág. B194
KIT DE SEGURIDAD ANTIVIBRACIONES - Safety antivibrations kit	Pág. B195

RACORES AUTOMÁTICOS TERMOPLÁSTICO - PLASTIC PUSH-IN FITTINGS

IMOPC  Pág. 4	IMOPC-G  Pág. 4	IMOPOC  Pág. 4	IMOPOC-M  Pág. 5	IMOPCF  Pág. 5	IMOPMF  Pág. 5
IMOPMM  Pág. 6	IMOPLM  Pág. 6	IMOPLS  Pág. 6	IMOPLS-G  Pág. 7	IMOPL  Pág. 7	IMOPL-G  Pág. 7
IMOPLL  Pág. 8	IMOPLL-G  Pág. 8	IMOPLF  Pág. 8	IMOPLF45  Pág. 9	IMOPLF45-G  Pág. 9	IMOPH  Pág. 9
IMOPH-G  Pág. 10	IMOPHF  Pág. 10	IMOPHF-G  Pág. 10	IMOPT  Pág. 11	IMOPT-G  Pág. 11	IMOPST  Pág. 11
IMOPST-G  Pág. 12	IMOPWT  Pág. 12	IMOPWT-G  Pág. 12	IMOPKD  Pág. 13	IMOPKD-G  Pág. 13	IMOPUC  Pág. 13
IMOPG  Pág. 13	IMOPUL  Pág. 13	IMOPUT  Pág. 14	IMOPGT  Pág. 14	IMOPY  Pág. 14	IMOPW  Pág. 14

IMOPZA  Pág. 14	IMOPK  Pág. 15	IMOPKG  Pág. 15	IMOPKJ  Pág. 15	IMOPLJ  Pág. 15	IMOPLGJ  Pág. 15
IMOPYJ  Pág. 16	IMOPWJ  Pág. 16	IMOPGJ  Pág. 16	IMOPIJ  Pág. 16	IMOPIG  Pág. 17	IMOPP  Pág. 17
IMOPPF NUEVO  Pág. 17					

RACORES AUTOMÁTICOS ESPECIALES - SPECIAL PUSH-IN FITTINGS















HPC NUEVO  Pág. 18	HPC-G NUEVO  Pág. 18	HCJ NUEVO  Pág. 18	HCJ-G NUEVO  Pág. 19	IMOPUCPRD  Pág. 19	IMOPCV  Pág. 19
---	---	---	---	--	---

RACORES AUTOMÁTICOS EN LATÓN NIQUELADO - BRASS PUSH-IN FITTINGS

IMOTC  Pág. 21	IMOTCF  Pág. 21	IMOTL  Pág. 21	IMOTLF NUEVO  Pág. 22	IMOTT  Pág. 22	IMOTST  Pág. 22
IMOTGJ  Pág. 22	IMOTUC  Pág. 23	IMOTG  Pág. 23	IMOTMM  Pág. 23	IMOTUL  Pág. 23	IMOTUT  Pág. 23

IMOTY  Pág. 24	IMOTA  Pág. 24	IMOTYJ  Pág. 24	IMOTP  Pág. 25	IMOTZA  NUEVO Pág. 25
--	--	---	---	--

RACORES AUTOMÁTICOS INOX AISI 316 - INOX AISI 316 PUSH-IN FITTINGS

IMOSXC  Pág. 28	IMOSXC-G  Pág. 28	IMOSXL  Pág. 28	IMOSXL-G  Pág. 28	IMOSXME  Pág. 29	IMOSXT  Pág. 29
IMOSXT-G  Pág. 29	IMOSXST  Pág. 29	IMOSXMM  Pág. 30	IMOSXUC  Pág. 30	IMOSXUL  Pág. 30	IMOSXUT  Pág. 30
IMOSXGJ  Pág. 31	IMOSXTA  Pág. 31				

RACORES ALIMENTARIOS ALTAS PRESTACIONES-MÉTRICA PLASTIC HIGH PERFORMANCE PUSH-IN FITTINGS-METRIC

NUEVO

HPC  Pág. 33	HPC-G  Pág. 33	HCF  Pág. 33	HPL  Pág. 33	HMM  Pág. 34	HCJ  Pág. 34
HCJ-G  Pág. 34	HGJ  Pág. 34	HLJ  Pág. 35	HUC  Pág. 35	HUL  Pág. 35	HUT  Pág. 35

HUY	HCP	HCVU	HBVU	PE
				
Pág. 36	Pág. 36	Pág. 36	Pág. 36	Pág. 36

**RACORES ALIMENTARIOS ALTAS PRESTACIONES-PULGADAS
PLASTIC HIGH PERFORMANCE PUSH-IN FITTINGS-INCHES**

NUEVO

HPC	HPC-G	HCL	HPMM	HCJ	HGJ
					
Pág. 38	Pág. 38	Pág. 38	Pág. 38	Pág. 39	Pág. 39
HLJ	HUC	HUL	HUT	HUY	HCP
					
Pág. 39	Pág. 39	Pág. 40	Pág. 40	Pág. 40	Pág. 40
HCF	HCVU	HBVU	PE		
					
Pág. 41	Pág. 41	Pág. 41	Pág. 41		

**RACORES AUTOMÁTICOS PARA ENGRASE CENTRALIZADO
CENTRALIZED LUBRICATION PUSH-IN FITTINGS**

NUEVO

IMOTEC	IMOTEL	IMOTELG	IMOTLEU	TP
				
Pág. 43	Pág. 43	Pág. 43	Pág. 43	Pág. 43

REGULADORES DE CAUDAL TIPO BANJO - BANJO FLOW REGULATORS



IMONSE	IMONSE-G	IMONSV-G	IMOTSC-C	IMOTSC-DC	IMOTSC-DFC
					
Pág. 51	Pág. 51	Pág. 51	Pág. 52	Pág. 52	Pág. 52
IMOXSC-D	IMOXSC-DF				
					
Pág. 53	Pág. 53				

REGULADORES DE CAUDAL CON VÁLVULA DE BLOQUEO PILOTADA FLOW REGULATORS WITH PILOT CHECK VALVE



NUEVO

PVSC	PVSC-G
	
Pág. 56	Pág. 57

REGULADORES DE CAUDAL EN LÍNEA - FLAT FLOW REGULATORS

IMONSF	IMOASF	IMOASF-B	XSF-U	XSF-U-NPT	XSF-B
					
Pág. 59	Pág. 60	Pág. 60	Pág. 61	Pág. 61	Pág. 62
XSF-B-NPT					
					
Pág. 62					

VÁLVULAS DE ESCAPE RÁPIDO - QUICK EXHAUST VALVE

IMO-VES	AVES	JVES
		
Pág. 63	Pág. 63	Pág. 63

VÁLVULAS MANUALES 3/2 VÍAS - HAND VALVES 3/2 LINES

NUEVO

HVC	HVC-G	HVF	HVF-G	HVU
				
Pág. 65	Pág. 65	Pág. 66	Pág. 66	Pág. 67

VÁLVULAS SEGURIDAD TARADAS - SAFETY TARES VALVES

NUEVO

IMOVST

Pág. 68

VÁLVULAS CON INTERRUPTOR NEUMÁTICO - PNEUMATIC VALVE SWITCH

NUEVO

IMOVN

Pág. 69

MANÓMETRO EN LÍNEA - PRESSURE GAUGE

NUEVO

IMOML

Pág. 71

VÁLVULA DE CORREDERA - SLIDE VALVES

IMO-VC



Pág. 72

VÁLVULA DE CORREDERA CON BLOQUE DE SEGURIDAD SLIDE VALVE WITH SECURITY BLOCK

IMO-VCS



Pág. 73

VÁLVULAS DE BLOQUEO - STOP FITTINGS

SPC



Pág. 75

SPC-G



Pág. 75

SPL



Pág. 75

SPL-G



Pág. 75

SPU



Pág. 75

VÁLVULAS ANTIRRETORNO - CHECK VALVES

CVPC



Pág. 77

CVPC-EN



Pág. 77

CVPU



Pág. 77

VAR-L



Pág. 77

VAR-X



Pág. 77

VAR-X316



Pág. 77

RACORES DE RESINA ACETAL - ACETAL RESIN PUSH-IN FITTINGS

NUEVO

IMORARM



Pág. 81

IMORARCM



Pág. 81

IMORART



Pág. 81

PUES



Pág. 81

RACORES DE POLIPROPILENO - POLYPROPYLENE RESIN PUSH-ON FITTINGS **NUEVO**

IMOPPRH  Pág. 83	IMOPPRM  Pág. 83	IMOPPRU  Pág. 83	IMOPPRCH  Pág. 83	IMOPPRCC  Pág. 84	IMOPPRCM  Pág. 84
IMOPPRTC  Pág. 84	IMOPPRTL  Pág. 85	IMOPPRT  Pág. 85	IMOPPRK  Pág. 85	IMOPPRDK  Pág. 86	IMOPPRE  Pág. 86
IMOPPRDE  Pág. 86	IMOTUBPPR  Pág. 87	IMOPPRHC  Pág. 87	IMOPPRMC  Pág. 87		

RACORES DE PVDF - PVDF PUSH-ON FITTINGS **NUEVO**

IMOPVRH  Pág. 89	IMOPVRM  Pág. 89	IMOPVRU  Pág. 89	IMOPVRCH  Pág. 89	IMOPVRCC  Pág. 90	IMOPVRCM  Pág. 90
IMOPVRTC  Pág. 90	IMOPVRTL  Pág. 91	IMOPVRT  Pág. 91	IMOTUBPPR  Pág. 91		

**RACORES CON TUERCA MOLETEADA EN LATÓN NIQUELADO
BRASS PUSH-ON FITTINGS**

IMORRCH  Pág. 93	IMORRC  Pág. 93	IMORRC-M  Pág. 93	IMORRC-G  Pág. 93	IMORU  Pág. 94	IMORP  Pág. 94
--	---	---	---	--	--

IMORCH  Pág. 94	IMORC  Pág. 95	IMORCM  Pág. 95	IMORCMK  Pág. 95	IMORZ  Pág. 96	IMORTC  Pág. 96
IMORTC-G NUEVO  Pág. 96	IMORTL  Pág. 97	IMORT  Pág. 97	IMORTUBI NUEVO  Pág. 97		

RACORES TUERCA MOLETEADA EN ACERO INOX AISI 316 INOX AISI 316 PUSH-ON FITTINGS

IMORRCX  Pág. 99	IMORRC-GX  Pág. 99	IMORCMX  Pág. 99	IMORCMKX  Pág. 99	IMORCMK-GX  Pág. 100	IMORTCX  Pág. 100
IMORTCKX  Pág. 100	IMORTCK-GX  Pág. 100	IMORTLX  Pág. 101	IMORCX  Pág. 101	IMORTX  Pág. 101	TMM  Pág. 101

RACORES CON BICONO EN LATÓN NIQUELADO - BRASS COMPRESSION FITTINGS

IMOBRC  Pág. 103	IMOBL  Pág. 103	IMOBLH  Pág. 103	IMOBT  Pág. 103	IMOBST  Pág. 104	IMOBUC  Pág. 104
IMOBMM  Pág. 104	IMOBUL  Pág. 104	IMOBUT  Pág. 104	IMOBRCF  Pág. 105	IMOTUBI  Pág. 105	BICONO  Pág. 105

REFBI



Pág. 105

**RACORES CON BICONO EN ACERO INOX AISI 316
COMPRESSION FITTINGS INOX AISI 316 - DIN 2353**

IMOBRC-X



Pág. 107

IMOBRC-G-X



Pág. 107

IMOBL-X



Pág. 107

IMOBT-X



Pág. 108

IMOBUC-X



Pág. 108

IMOBMM-X



Pág. 108

IMOBUL-X



Pág. 108

IMOBUT-X



Pág. 109

IMOBZ-X



Pág. 109

IMOTUBI-X



Pág. 109

BICONO-X

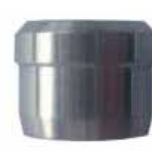

Pág. 109

REFBI-X



Pág. 109

ACCESORIOS ROSCADOS EN LATÓN NIQUELADO - BRASS STANDARD FITTINGS



Pág. 110



Pág. 111



Pág. 111



Pág. 111



Pág. 111



Pág. 112



Pág. 112



Pág. 112



Pág. 112



Pág. 113



Pág. 113



Pág. 113



Pág. 113



Pág. 114



Pág. 114



Pág. 114



Pág. 114



Pág. 115

 Pág. 115	 Pág. 115	 Pág. 115 NUEVO	 Pág. 116	 Pág. 116	 Pág. 116
 Pág. 116	 Pág. 116	 Pág. 117	 Pág. 117	 Pág. 117	 Pág. 117
 Pág. 118	 Pág. 118	 Pág. 118	 Pág. 118	 Pág. 118	 Pág. 119
 Pág. 119	 Pág. 119	 Pág. 119	 Pág. 119 NUEVO		

ACCESORIOS ROSCADOS INOX AISI 303-316 - STANDARD FITTINGS INOX AISI 303-316

 Pág. 120	 Pág. 120	 Pág. 120	 Pág. 121	 Pág. 121	 Pág. 121
 Pág. 121	 Pág. 121				

ACCESORIOS ROSCADOS INOX AISI 316 MICROFUSIÓN STANDARD FITTINGS INOX AISI 316 MICROFUSION

FIGURA 90  Pág. 123	FIGURA 92  Pág. 123	FIGURA 120  Pág. 123	FIGURA 130  Pág. 123	FIGURA 180  Pág. 124 NUEVO	FIGURA 290  Pág. 124
---	---	--	--	---	--

FIGURA 300  Pág. 124	FIGURA 149  Pág. 124	FIGURA 150  Pág. 125	FIGURA 240  Pág. 125	FIGURA 246  Pág. 125	FIGURA 241  Pág. 125
FIGURA 245  Pág. 126	FIGURA 270  Pág. 126	FIGURA 280  Pág. 126	FIGURA 399  Pág. 126	FIGURA 531  Pág. 127	FIGURA 312  Pág. 127
FIGURA 85  Pág. 127	FIGURA 330  Pág. 127	FIGURA 340  Pág. 127	FIGURA 340S  Pág. 128	FIGURA 331  Pág. 128	FIGURA 341  Pág. 128
FIGURA 599  Pág. 128	FIGURA 601  Pág. 129	FIGURA 602  Pág. 129	FIGURA 603  Pág. 129	FILTRO EN "Y"  Pág. 129	

DISTRIBUIDORES DE ALUMINIO - DISTRIBUTION MANIFOLDS IN ALUMINIUM

DIS-H  Pág. 131	DISL  Pág. 131	DISDB  Pág. 131
---	--	---

MICROVÁLVULAS DE ESFERA EN LATÓN - BRASS MICRO BALL VALVES

MICROVAL H  Pág. 134	MICROVAL H M  Pág. 134	MICROVAL M  Pág. 134	MICROVAL  Pág. 134
--	--	--	--

MINIVÁLVULAS DE ESFERA EN LATÓN - BRASS MICRO BALL VALVES

MINIVAL H	MINIVAL H M	MINIVAL M M	MANETAS
			
Pág. 135	Pág. 135	Pág. 135	Pág. 135

VÁLVULAS DE ESFERA EN LATÓN - BRASS BALL VALVES

VAL H

Pág. 136

VÁLVULAS DE ESFERA EN LATÓN MANDO DE MARIPOSA BRASS BALL VALVES - BUTTERFLY HANDLE

VALMAR H	VALMAR H M
	
Pág. 137	Pág. 137

GRIFO DE ESFERA EN LATÓN PARA MANGUERA BALL BIBCOCK WITH HOSE CONNECTOR

VALGRIF

Pág. 138

MINIVÁLVULAS DE ESFERA EN ACERO INOX AISI 316 MINI BALL VALVES INOX AISI 316

M.VAL H X	M.VAL H M X
	
Pág. 139	Pág. 139

VÁLVULAS DE ESFERA EN ACERO INOX AISI 316 - BALL VALVES INOX AISI 316

VAL H X



Pág. 140

**VÁLVULAS DE ESFERA EN INOX AISI 316 MICROFUSIÓN
BALL VALVES INOX AISI 316 MICROFUSION**

M. VAL HX D



Pág. 141

ELECTROVÁLVULAS INOX AISI 316 L - SOLENOID VALVES INOX AISI 316 L

SVXC2C



Pág. 146

SVX2C



Pág. 146

SVX3C



Pág. 146

SILENCIADORES - SILENCERS

SILENALT



Pág. 149

SILENALTH



Pág. 149

SILENBAJ



Pág. 149

IMOSIL-ESC



Pág. 150

SILENNY



Pág. 150

SILENP



Pág. 150

SILENBAJNX



Pág. 151

SILENBAJX



Pág. 151

DEPÓSITOS - TANKS

NUEVO

SB



Pág. 153

SB-STL



Pág. 153

SB-STC



Pág. 154

SB-STV



Pág. 155

SELLADORES DE ROSCAS

SELLADORES DE ROSCA



Pág. 157

FIJADORES DE ROSCAS

FIJADORES DE ROSCAS



Pág. 158

FORMADORES DE JUNTAS

FORMADORES DE JUNTAS



Pág. 159

RETENEDORES

RETENEDORES



Pág. 159

ADHESIVOS INSTANTÁNEOS

ADHESIVOS INSTANTÁNEOS



Pág. 160

VARIOS

VARIOS



Pág. 160

ARANDELAS - WASHERS

2610



Pág. 161

2612



Pág. 161

ABRAZADERAS - CLAMPS

AB



Pág. 163

ABX



Pág. 163

ABO2



Pág. 163

ABO2X



Pág. 163

RACORES FIJOS Y GIRATORIOS PARA MANGUERA - JOINTS FOR SPIRAL HOSES



Pág. 164



Pág. 164



Pág. 164







Pág. 164

ACCESORIOS PARA TUBOS - CLAMPS

				
Pág. 165	Pág. 165	Pág. 165	Pág. 165	Pág. 165

MANÓMETROS Y VACUÓMETROS - PRESSURE GAUGES

MANR 	MANP 	MANÓMETRO 	VAC 	MANRG 	MANRGX 
Pág. 167	Pág. 167	Pág. 167	Pág. 167	Pág. 168	Pág. 168

PISTOLAS DE SOPLADO - AIR GUNS

PSF 	L 	PSF-1010-4 	IMOPS 	PS10-V 	IPS-SR-OSHA 
Pág. 169	Pág. 169	Pág. 169	Pág. 170	Pág. 170	Pág. 171
IPS 	IPS-REG 	IPS-TURBO 	IPS- 		
Pág. 172	Pág. 172	Pág. 172	Pág. 172		

INFLADORES - TYRE-INFLATING GUNS

INF-EURO-02 	INF-HOM-01 	INF-AL-02 
Pág. 173	Pág. 173	Pág. 173

INFLADORES, BOQUILLAS Y KIT DE SOPLADO - TYRE-INFLATING GUNS AIR GUN KIT

<p>IMO-BOQ</p>	<p>KIT</p>	<p>KIT CO2</p>
		 <p style="text-align: right; color: red;">NUEVO</p>
<p>Pág. 174</p>	<p>Pág. 174</p>	<p>Pág. 174</p>

TUBERÍAS - TUBES

<p>TPU/DPU</p>	<p>EPU</p>	<p>TP/DP</p>	<p>EP</p>	<p>TUBCA</p>	<p>TUBAIR</p>
					
<p>Pág. 176</p>	<p>Pág. 177</p>	<p>Pág. 178</p>	<p>Pág. 179</p>	<p>Pág. 180</p>	<p>Pág. 180</p>
<p>TUBAIR</p>	<p>PRESAIR</p>	<p>PUH/DPUH</p>	<p>IMOPTFE</p>	<p>PE</p>	<p>TUBCOMB</p>
	 <p style="text-align: right; color: red;">NUEVO</p>			 <p style="text-align: right; color: red;">NUEVO</p>	
<p>Pág. 181</p>	<p>Pág. 181</p>	<p>Pág. 182</p>	<p>Pág. 183</p>	<p>Pág. 184</p>	<p>Pág. 185</p>
<p>TLIMP</p>	<p>TUBTRANS</p>	<p>TUBFLEX</p>	<p>TUBEX</p>	<p>DPU/PU</p>	<p>AS</p>
			 <p style="text-align: right; color: red;">NUEVO</p>		
<p>Pág. 185</p>	<p>Pág. 186</p>	<p>Pág. 186</p>	<p>Pág. 187</p>	<p>Pág. 188</p>	<p>Pág. 189</p>
<p>ASR</p>	<p>3470</p>	<p>3471</p>	<p>3472</p>	<p>3474</p>	<p>3467</p>
 <p style="text-align: right; color: red;">NUEVO</p>					 <p style="text-align: right; color: red;">NUEVO</p>
<p>Pág. 190</p>	<p>Pág. 190</p>	<p>Pág. 190</p>	<p>Pág. 190</p>	<p>Pág. 191</p>	<p>Pág. 191</p>
<p>3468</p>	<p>PUKS</p>				
 <p style="text-align: right; color: red;">NUEVO</p>					
<p>Pág. 191</p>	<p>Pág. 192</p>				

ENROLLADORES - REELS

500117/500118	EN	ENPOR	EN-1020	SOP-PAR
				
Pág. 193	Pág. 193	Pág. 194	Pág. 194	Pág. 194

KIT SEGURIDAD ANTIVIBRACIONES - SAFETY ANTIVIBRATION KIT

NUEVO

RACORES AUTOMÁTICOS

Push-in fittings

AISI 316

RACORES AUTOMÁTICOS TERMOPLÁSTICO · *Plastic push-in fittings*

RACORES AUTOMÁTICOS EN LATÓN · *Brass push-in fittings*

RACORES AUTOMÁTICOS INOX AISI 316 · *Push-in fittings INOX AISI 316*

NUEVO RACORES ALIMENTARIOS DE ALTAS PRESTACIONES- métrica

Plastic high performance push-in fittings-metric

NUEVO RACORES ALIMENTARIOS DE ALTAS PRESTACIONES- pulgadas

Plastic high performance push-in fittings-inches

NUEVO RACORES AUTOMÁTICOS PARA ENGRASE CENTRALIZADO

Centralized lubrication push-in fittings



INSTRUCCIONES PARA EL CORRECTO USO DEL RACOR

- No utilizar el racor de esta serie con fluidos distintos al aire comprimido.
- Contactar con el Departamento Técnico de IMOPAC para el uso con otros fluidos.
- Se recomienda prevenir eventuales aumentos de la presión, vibraciones, rotaciones y estrangulamientos de la tubería.
- No utilizar el racor en ambientes donde estén presentes chispas de soldadura.
- Vibraciones o rotaciones inapropiadas del racor podrían comprometer la funcionalidad del mismo y causar fugas.
- No utilizar el racor expuesto directamente a fluidos como taladrina, aceite refrigerante y lubricantes.
- Introducir la tubería en el racor una vez limpia de impurezas y suciedad.

ATENCIÓN

- Cortar el tubo a 90° mediante la utilización de un cortatubos apropiado.
- Introducir el tubo hasta el tope del racor y tirar de la tubería hacia atrás para asegurar que ha sido correctamente insertada y no se escapa.
- Evitar ralladuras e imperfecciones de la superficie del tubo, deformaciones o un aspecto ovalado ya que puede producir fugas y desconexiones imprevistas.
- El diámetro exterior del tubo de poliuretano, puede expandirse en función de la temperatura y la presión aplicada. En estos casos la reinserción del racor podría no ser posible, comprobar el diámetro exterior del tubo y sustituirlo por otro nuevo.

RECOMENDACIONES PARA LA CONEXIÓN DEL TUBO AL RACOR

- Asegurarse que la presión es cero antes de hacer la conexión del tubo al racor.
- Para desconectar el tubo presionar el anillo pulsador hasta el final y tirar del tubo con una mano.
- Cortar la parte del tubo sujeta al racor para posteriores reutilizaciones del mismo.

WARNING

- Do not use them on fluids other than air.
- Contact IMOPAC for use on other fluids. We don't recommend or guarantee to use them for other purposes.
- Be sure to prevent pressure buildup caused by twisting, pulling and bending of the fitting product.
- Do not use the product where weld spatters occur as fire may break out.
- Product damage or air leakage may occur at places where there is rotation and vibration, Choose the right product from our catalogue.
- Do not use the product where it is directly exposed to fluids such as cutting oil, lubricating oil and coolant oil.
- Assemble the pipes only after clearing away impurities such as dust.

CAUTION FOR THE INSERTION OF THE TUBE TO THE FITTING PRODUCT

- Make sure the tube is inserted fully to the end of the fitting.
- To insert the tube into the fitting, cut the tube at a right angle 90°, insert it to the end and pull the tube gently to make sure it isn't released.
- If there are any damages or scratches on the tube surface or an oval shape, air leakage and tube release may occur. Check it meticulously.
- The OD of polyurethane tube expands by pressure applied on them. reinsertion to the fitting may not be possible. Check the OD of the tube and change the tube if the expansion is serious.

CAUTION FOR THE INSERTION OF THE TUBE TO THE FITTING PRODUCT

- Make sure the pressure is zero before releasing the tube from the fitting product.
- To release the tube, press the release ring regularly at the end and pull the tube with one hand.
- Cut the pressed part of the tube for reuse of the released tube.

Directo rosca macho cónica BSPT niquelado • Male connector BSPT thread nickel plated

IMOPC	REFERENCIA	ØD	T	I	L	H (Hex)	Peso Weight(g)
	IMOPC0401	4	R1/8"	7,0	19,3	10	6,2
	IMOPC0402		R1/4"	9,5	17,9	14	9,8
	IMOPC0601	6	R1/8"	7,0	20,4	12	6,9
	IMOPC0602		R1/4"	9,5	22,7	14	13,3
	IMOPC0603		R3/8"	10,5	20,7	17	19,9
	IMOPC0604		R1/2"	13,5	24,7	21	39,8
	IMOPC0801	8	R1/8"	7,0	25,4	14	10,0
	IMOPC0802		R1/4"	9,5	24,9	14	11,9
	IMOPC0803		R3/8"	10,5	21,9	17	17,5
	IMOPC0804		R1/2"	13,5	25,9	21	37,6
	IMOPC1001	10	R1/8"	7,0	27,7	17	16,4
	IMOPC1002		R1/4"	9,5	29,5	17	18,6
	IMOPC1003		R3/8"	10,5	27,0	17	20,7
	IMOPC1004		R1/2"	13,5	25,3	21	34,6
	IMOPC1202	12	R1/4"	9,5	32,9	20	24,5
	IMOPC1203		R3/8"	10,5	29,9	20	25,3
IMOPC1204	R1/2"		13,5	32,9	21	41,0	
IMOPC1603	16	R3/8"	10,5	37,6	24	42,0	
IMOPC1604		R1/2"	13,5	35,6	24	42,1	



Directo rosca macho cilíndrica BSPP y métrica niquelado • Male connector BSPP & metric thread nickel plated

IMOPC-G	REFERENCIA	ØD	T	I	L	B	H (Hex)	Peso Weight(g)
	IMOPC04M5	4	M5	3,8	20,1	10,5	10	5,7
	IMOPC04M6		M6	4,5	20,8	10,5	10	6,1
	IMOPC04-G01		G1/8"	5,0	19,3	7,4	10	7,4
	IMOPC04-G02		G1/4"	5,8	16,6	3,9	10	9,4
	IMOPC06M5	6	M5	3,8	21,2	10,5	12	7,4
	IMOPC06M6		M6	4,5	21,7	10,5	12	7,0
	IMOPC06-G01		G1/8"	5,0	19,9	6,7	12	7,5
	IMOPC06-G02		G1/4"	5,8	20,4	6,4	12	10,8
	IMOPC06-G03	8	G3/8"	6,8	20,0	4,5	12	17,0
	IMOPC06-G04		G1/2"	8,0	21,7	4,5	12	27,5
	IMOPC08-G01		G1/8"	5,0	24,4	11,1	14	11,7
	IMOPC08-G02		G1/4"	5,8	22,2	7,0	14	11,1
	IMOPC08-G03	10	G3/8"	6,8	21,2	4,5	14	15,7
	IMOPC08-G04		G1/2"	8,0	22,9	4,5	14	27,0
	IMOPC10-G01		G1/8"	5,0	26,3	11,0	17	15,9
	IMOPC10-G02		G1/4"	5,8	27,5	13,9	17	20,4
	IMOPC10-G03	12	G3/8"	6,8	25,0	8,9	17	20,6
	IMOPC10-G04		G1/2"	8,0	22,7	4,9	17	28,5
	IMOPC12-G02		G1/4"	5,8	31,2	12,0	20	26,3
	IMOPC12-G03		G3/8"	6,8	28,2	11,0	20	24,3
	IMOPC12-G04	14	G1/2"	8,0	28,9	9,5	20	33,3
	IMOPC14-G03		G3/8"	6,8	31,8	13,0	21	30,0
	IMOPC14-G04		G1/2"	8,0	29,5	10,0	24	20,0
	IMOPC16-G03		16	G3/8"	6,8	34,9	14,5	24
IMOPC16-G04	G1/2"	8,0		36,1	18,0	24	50,7	

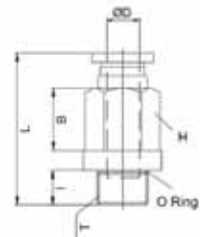

Directo rosca macho cónica BSPT hexágono interior niquelado • Male connector internal hexagon BSPT thread nickel plated

IMOPOC	REFERENCIA	ØD	T	I	L	øP	H (Hex)	Peso Weight(g)
	IMOPOC0401	4	R1/8"	7,0	19,3	10	3	5,6
	IMOPOC0402		R1/4"	9,5	17,9	14	3	11,2
	IMOPOC0601	6	R1/8"	7,0	20,4	12	4	6,3
	IMOPOC0602		R1/4"	9,5	22,7	14	4	12,5
	IMOPOC0603		R3/8"	10,5	20,7	17	4	19,0
	IMOPOC0801		8	R1/8"	7,0	25,4	14	5
	IMOPOC0802	R1/4"		9,5	24,9	14	6	13,1
	IMOPOC0803	R3/8"		10,5	21,9	17	6	17,3
	IMOPOC0804	R1/2"		13,5	25,9	21	6	37,9
	IMOPOC1001	10	R1/8"	7,0	27,7	17	5	20,8
	IMOPOC1002		R1/4"	9,5	29,5	17	6	22,5
	IMOPOC1003		R3/8"	10,5	27,0	17	8	22,6
	IMOPOC1004		R1/2"	13,5	25,3	21	8	34,0
	IMOPOC1202	12	R1/4"	9,5	32,9	20	6	21,5
	IMOPOC1203		R3/8"	10,5	29,9	20	8	22,2
	IMOPOC1204		R1/2"	13,5	32,9	21	8	37,3



Directo rosca macho métrica hexágono interior niquelado • Male connector internal hexagon metric thread nickel plated

IMOPOC-M	REFERENCIA	ØD	T	I	L	øP	H (Hex)	Peso Weight(g)
	IMOPOC04M5	4	M5x0,8	3,8	20,1	10	2	5,2
	IMOPOC04M6		M6x1,0	4,5	20,8	10	2	5,6
	IMOPOC06M5	6	M5x0,8	3,8	21,0	12	2	6,8
	IMOPOC06M6		M6x1,0	4,5	21,7	12	2	7,2

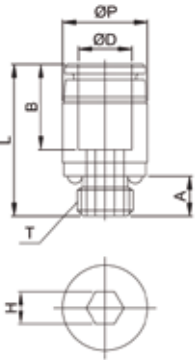

Directo rosca hembra cilíndrica BSPP niquelado • Female connector BSPP thread nickel plated

IMOPCF	REFERENCIA	ØD	T	I	L	H (Hex)	Peso Weight(g)
	IMOPCF0401	4	G1/8"	7,0	22,3	14	12,5
	IMOPCF0402		G1/4"	9,0	25,3	17	18,0
	IMOPCF0601	6	G1/8"	7,0	24,4	14	15,0
	IMOPCF0602		G1/4"	9,0	26,4	17	19,3
	IMOPCF0603		G3/8"	10,0	27,4	19	26,3
	IMOPCF0801	8	G1/8"	7,0	25,9	14	15,8
	IMOPCF0802		G1/4"	9,0	27,9	17	19,4
	IMOPCF0803		G3/8"	10,0	28,9	19	18,4
	IMOPCF0804		G1/2"	12,0	30,9	24	32,8
	IMOPCF1001	10	G1/8"	7,0	27,7	17	28,5
	IMOPCF1002		G1/4"	9,0	29,7	17	27,0
	IMOPCF1003		G3/8"	10,0	30,7	19	24,6
	IMOPCF1004		G1/2"	12,0	32,7	24	38,5
	IMOPCF1202	12	G1/4"	9,0	32,9	20	44,2
IMOPCF1203	G3/8"		10,0	33,9	20	35,9	
IMOPCF1204	G1/2"		12,0	35,9	24	34,2	

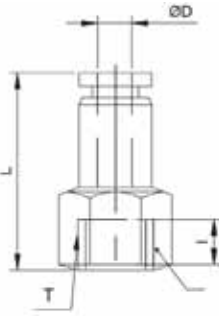

Pasatabique rosca hembra cilíndrica BSPP niquelado • Bulkhead female connector BSPP thread nickel plated

IMOPMF	REFERENCIA	ØD	T1	T2	I	L1	L2	H1 (Hex)	H2 (Hex)	Peso Weight(g)
	IMOPMF0401	4	G1/8"	M12x1,0	7	23,3	9,5	14	14	15,5
	IMOPMF0402		G1/4"		9	25,4	11,6	17	14	20,4
	IMOPMF0601	6	G1/8"	M14x1,0	7	24,2	7,0	17	17	26,3
	IMOPMF0602		G1/4"		9	29,2	12,0	17	17	26,5
	IMOPMF0603		G3/8"		10	30,2	13,0	19	17	35,1
	IMOPMF0801	8	G1/8"	M16x1,0	7	27,4	5,0	19	19	32,0
	IMOPMF0802		G1/4"		9	34,4	12,0	19	19	42,4
	IMOPMF0803		G3/8"		10	34,4	13,0	19	19	42,4
	IMOPMF0804		G1/2"		12	36,4	15,0	24	19	47,7
	IMOPMF1001	10	G1/8"	M20x1,0	7	28,4	7,7	21	24	52,8
	IMOPMF1002		G1/4"		9	30,4	9,7	21	24	53,5
	IMOPMF1003		G3/8"		10	33,7	13,0	21	24	53,8
	IMOPMF1004		G1/2"		12	35,7	15,0	24	24	58,8
	IMOPMF1202	12	G1/4"	M22x1,0	9	33,5	9,1	24	27	68,2
	IMOPMF1203		G3/8"		10	34,4	10,0	24	27	62,7
	IMOPMF1204		G1/2"		12	39,4	15,0	24	27	62,3

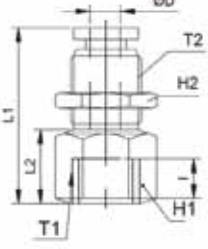

Pasatabique tubo-tubo niquelado • Bulkhead connector nickel plated

IMOPMM	REFERENCIA	ØD	T	E	L	F	H (Hex)	Peso Weight(g)
	IMOPMM04	4	M12x1,0	9,7	30,1	3,5	14	15,4
	IMOPMM06	6	M14x1,0	7,5	31,8	4,0	17	21,4
	IMOPMM08	8	M16x1,0	6,8	35,3	4,5	19	26,8
	IMOPMM10	10	M20x1,0	11,5	39,0	5,0	24	52,7
	IMOPMM12	12	M22x1,0	12,8	45,3	5,0	27	59,8

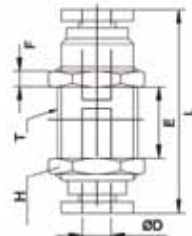

Codo pasatabique niquelado • Bulkhead elbow nickel plated

IMOPLM	REFERENCIA	ØD1	ØD2	T	L	E	H1 (Hex)	H2 (Hex)	Peso Weight(g)
	IMOPLM04	4	4	M12x1,0	28,5	17,5	14	14	15,0
	IMOPLM06	6	6	M14x1,0	34,8	19,0	17	17	27,2
	IMOPLM08	8	8	M16x1,0	43,4	22,8	17	19	38,0
	IMOPLM10	10	10	M20x1,0	45,5	26,3	21	24	55,0
	IMOPLM12	12	12	M22x1,0	51,3	29,6	24	27	85,0

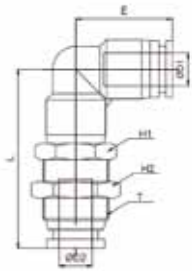

Codo reducido orientable rosca macho cónica BSPT niquelado • Short male elbow BSPT thread nickel plated

IMOPLS	REFERENCIA	ØD	T	I	L	E	H (Hex)	Peso Weight(g)
	IMOPLS0401	4	R1/8"	7,0	16,0	17,5	10	5,8
	IMOPLS0402		R1/4"	9,5	19,5	17,5	14	6,3
	IMOPLS0601	6	R1/8"	7,0	17,0	19,0	10	6,4
	IMOPLS0602		R1/4"	9,5	20,5	19,0	14	12,4
	IMOPLS0603		R3/8"	10,5	22,0	19,0	17	14,2
	IMOPLS0604		R1/2"	13,5	25,5	19,0	21	17,3
	IMOPLS0801	8	R1/8"	7,0	21,3	22,8	12	11,5
	IMOPLS0802		R1/4"	9,5	21,5	22,8	14	13,3
	IMOPLS0803		R3/8"	10,5	23,0	22,8	17	20,3
	IMOPLS0804		R1/2"	13,5	26,5	22,8	21	21,9
	IMOPLS1001	10	R1/8"	7,0	25,5	26,3	14	15,4
	IMOPLS1002		R1/4"	9,5	26,0	26,3	14	18,4
	IMOPLS1003		R3/8"	10,5	25,0	26,3	17	21,9
	IMOPLS1004		R1/2"	13,5	28,5	26,3	21	24,8
	IMOPLS1202	12	R1/4"	9,5	29,5	29,6	17	33,6
	IMOPLS1203		R3/8"	10,5	26,5	29,6	17	36,2
IMOPLS1204	R1/2"		13,5	30,0	29,6	21	39,5	

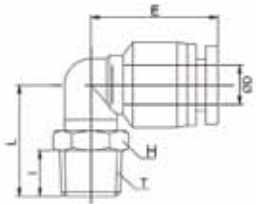

Codo reducido orientable rosca macho cilíndrica BSPP y métrica niquelado • Short male elbow BSPP & metric thread nickel plated

IMOPLS-G	REFERENCIA	ØD	T	I	L	E	H (Hex)	Peso Weight(g)
	IMOPLS04M5	4	M5x0,8	3,8	15,3	17,5	8	5,2
	IMOPLS04-G01		G1/8"	4,8	14,8	17,5	14	7,6
	IMOPLS04-G02		G1/4"	5,5	16,0	17,5	17	11,3
	IMOPLS06M5	6	M6x0,8	3,8	15,3	19,0	8	5,8
	IMOPLS06-G01		G1/8"	4,8	15,8	19,0	14	8,3
	IMOPLS06-G02		G1/4"	5,5	17,0	19,0	17	13,3
	IMOPLS06-G03		G3/8"	6,5	18,5	19,0	20	16,8
	IMOPLS06-G04	G1/2"	7,5	19,5	19,0	24	20,1	
	IMOPLS08-G01	8	G1/8"	4,8	20,0	22,8	14	11,9
	IMOPLS08-G02		G1/4"	5,5	18,0	22,8	17	13,8
	IMOPLS08-G03		G3/8"	6,5	19,5	22,8	20	21,2
	IMOPLS08-G04		G1/2"	7,5	20,5	22,8	24	24,3
IMOPLS10-G01	10	G1/8"	4,8	24,3	26,3	14	21,3	
IMOPLS10-G02		G1/4"	5,5	23,1	26,3	17	24,3	
IMOPLS10-G03		G3/8"	6,5	21,5	26,3	20	24,3	
IMOPLS10-G04		G1/2"	7,5	22,5	26,3	24	31,2	
IMOPLS12-G02	12	G1/4"	5,5	16,5	29,6	17	33,8	
IMOPLS12-G03		G3/8"	6,5	23,0	29,6	20	35,6	
IMOPLS12-G04		G1/2"	7,5	24,0	29,6	24	39,8	

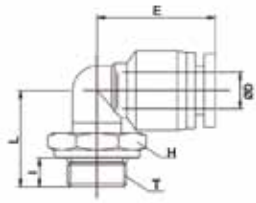

Codo orientable rosca macho cónica BSPT niquelado • Swivel male elbow BSPT thread nichel plated

IMOPL	REFERENCIA	ØD	T	I	L	E	H (Hex)	Peso Weight(g)
	IMOPL0401	4	R1/8"	7,0	23,5	17,5	10	8,1
	IMOPL0402		R1/4"	9,5	27,0	17,5	14	13,9
	IMOPL0601	6	R1/8"	7,0	25,2	19,0	12	11,5
	IMOPL0602		R1/4"	9,5	28,2	19,0	14	16,5
	IMOPL0603		R3/8"	10,5	29,7	19,0	17	22,6
	IMOPL0604		R1/2"	13,5	33,2	19,0	21	35,9
	IMOPL0801	8	R1/8"	7,0	29,0	22,8	14	17,6
	IMOPL0802		R1/4"	9,5	31,5	22,8	14	17,7
	IMOPL0803		R3/8"	10,5	33,0	22,8	17	25,3
	IMOPL0804		R1/2"	13,5	36,5	22,8	21	38,2
	IMOPL1001	10	R1/8"	7,0	33,8	26,3	17	30,7
	IMOPL1002		R1/4"	9,5	36,3	26,3	17	31,4
	IMOPL1003		R3/8"	10,5	37,3	26,3	17	30,8
	IMOPL1004		R1/2"	13,5	40,8	26,3	21	47,3
	IMOPL1202	12	R1/4"	9,5	38,5	29,6	21	44,3
	IMOPL1203		R3/8"	10,5	39,5	29,6	21	46,7
	IMOPL1204		R1/2"	13,5	42,5	29,6	21	51,2
	IMOPL1403	14	R3/8"	10,5	41,5	31,7	24	53,0
IMOPL1404	R1/2"		13,5	45,5	31,7	24	62,0	
IMOPL1603	16	R3/8"	10,5	43,0	33,0	24	67,6	
IMOPL1604		R1/2"	13,5	46,0	33,0	24	72,8	

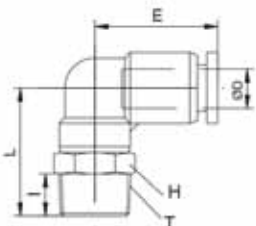

Codo orientable rosca macho cilíndrica BSPP y métrica niquelado • Swivel male elbow BSPP & metric thread nickel plate

IMOPL-G	REFERENCIA	ØD	T	I	L	E	H (Hex)	Peso Weight(g)
	IMOPL04M5	4	M5x0,8	3,8	17,3	17,5	8	5,1
	IMOPL04M6		M6x1	4,5	18,0	17,5	8	5,3
	IMOPL04-G01		G1/8"	5,0	24,0	17,5	14	11,8
	IMOPL04-G02		G1/4"	5,8	25,3	17,5	17	17,9
	IMOPL06M5	6	M5x0,8	3,8	17,3	19,0	8	5,8
	IMOPL06M6		M6x1	4,5	18,0	19,0	8	6,0
	IMOPL06-G01		G1/8"	5,0	25,2	19,0	14	14,6
	IMOPL06-G02		G1/4"	5,8	26,5	19,0	17	17,5
	IMOPL06-G03	G3/8"	6,8	28,0	19,0	20	24,4	
	IMOPL06-G04	G1/2"	8,0	29,2	19,0	24	38,4	
	IMOPL08-G01	8	G1/8"	5,0	28,5	22,8	14	17,5
	IMOPL08-G02		G1/4"	5,8	29,8	22,8	17	20,5
	IMOPL08-G03		G3/8"	6,8	31,3	22,8	20	26,6
	IMOPL08-G04		G1/2"	8,0	32,5	22,8	24	36,8
	IMOPL10-G01	10	G1/8"	5,0	33,3	26,3	17	31,2
	IMOPL10-G02		G1/4"	5,8	34,1	26,3	17	30,5
	IMOPL10-G03		G3/8"	6,8	35,6	26,3	20	34,6
	IMOPL10-G04		G1/2"	8,0	37,8	26,3	24	47,3
	IMOPL12-G02	12	G1/4"	5,8	36,8	29,6	21	43,9
	IMOPL12-G03		G3/8"	6,8	37,8	29,6	21	44,5
	IMOPL12-G04		G1/2"	8,0	39,5	29,6	24	51,8
	IMOPL14-G03	14	G3/8"	8,0	40,8	33,0	21	52,0
	IMOPL14-G04		G1/2"	9,3	42,0	33,0	24	61,0
	IMOPL16-G03	16	G3/8"	7,5	40,8	33,0	24	64,0
IMOPL16-G04	G1/2"		8,0	42,0	33,0	24	66,5	

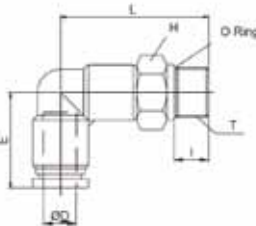

Codo prolongado orientable rosca macho cónica BSPT niquelado • Long swivel male elbow BSPT thread nickel plated

IMOPLL	REFERENCIA	ØD	T	I	L	E	H (Hex)	Peso Weight(g)
	IMOPLL0401	4	R1/8"	7,0	35,5	17,5	10	14,2
	IMOPLL0402		R1/4"	9,5	39,0	17,5	14	26,2
	IMOPLL0601	6	R1/8"	7,0	39,2	19,0	12	22,0
	IMOPLL0602		R1/4"	9,5	42,2	19,0	14	29,2
	IMOPLL0603		R3/8"	10,5	43,7	19,0	17	39,4
	IMOPLL0604		R1/2"	13,5	47,2	19,0	21	62,9
	IMOPLL0801	8	R1/8"	7,0	44,3	22,8	14	34,6
	IMOPLL0802		R1/4"	9,5	46,8	22,8	14	33,1
	IMOPLL0803		R3/8"	10,5	48,3	22,8	17	45,6
	IMOPLL0804		R1/2"	13,5	51,8	22,8	21	70,1
	IMOPLL1001	10	R1/8"	7,0	53,8	26,3	17	61,2
	IMOPLL1002		R1/4"	9,5	56,3	26,3	17	62,5
	IMOPLL1003		R3/8"	10,5	57,3	26,3	17	56,7
	IMOPLL1004		R1/2"	13,5	60,8	26,3	21	87,2
	IMOPLL1202	12	R1/4"	9,5	61,5	29,6	21	86,7
	IMOPLL1203		R3/8"	10,5	62,5	29,6	21	100,7
IMOPLL1204	R1/2"		13,5	65,5	29,6	21	89,7	

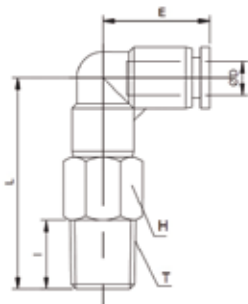

Codo prolongado orientable rosca macho cilíndrica BSPP y métrica niquelado • Long swivel male elbow BSPP & metric thread nickel plated

IMOPLL-G	REFERENCIA	ØD	T	I	L	E	H (Hex)	Peso Weight(g)	
	IMOPLL04M5	4	M5x0,8	3,8	29,3	17,5	8	10,4	
	IMOPLL04M6		M6x1,0	4,5	30,0	17,5	8	10,8	
	IMOPLL04-G01		G1/8"	5,0	36,0	17,5	14	25,9	
	IMOPLL04-G02		G1/4"	5,8	37,3	17,5	17	26,6	
	IMOPLL06M5	6	M5x0,8	3,8	31,3	19,0	8	11,4	
	IMOPLL06M6		M6x1,0	4,5	32,0	19,0	8	11,8	
	IMOPLL06-G01		G1/8"	5,0	39,2	19,0	14	30,5	
	IMOPLL06-G02		G1/4"	5,8	40,5	19,0	17	43,3	
	IMOPLL06-G03	6	G3/8"	6,8	42,0	19,0	20	57,0	
	IMOPLL06-G04		G1/2"	8,0	43,2	19,0	24	91,5	
	IMOPLL08-G01		8	G1/8"	5,0	43,8	22,8	14	35,4
	IMOPLL08-G02			G1/4"	5,8	45,1	22,8	17	48,0
	IMOPLL08-G03	G3/8"		6,8	46,6	22,8	20	60,3	
	IMOPLL08-G04	G1/2"		8,0	47,8	22,8	24	93,7	
	IMOPLL10-G01	10	G1/8"	5,0	53,3	26,3	17	61,8	
	IMOPLL10-G02		G1/4"	5,8	54,1	26,3	17	68,7	
	IMOPLL10-G03		G3/8"	6,8	55,6	26,3	20	78,7	
	IMOPLL10-G04		G1/2"	8,0	57,8	26,3	24	105,8	
	IMOPLL12-G02	12	G1/4"	5,8	59,8	29,6	21	98,1	
	IMOPLL12-G03		G3/8"	6,8	60,8	29,6	21	101,9	
	IMOPLL12-G04		G1/2"	8,0	62,5	29,6	24	124,3	

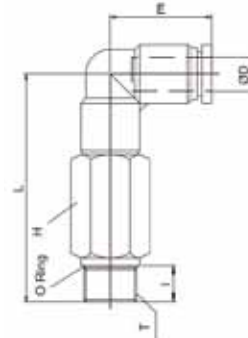

Codo orientable rosca hembra cilíndrica BSPP y métrica niquelado • Swivel female elbow BSPP & metric thread nickel plated

IMOPLF	REFERENCIA	ØD	T	I	L	E	H (Hex)	Peso Weight(g)	
	IMOPLF04M5	4	M5x0,8	4,5	19,5	17,5	10	7,4	
	IMOPLF04M6		M6x1,0	5,0	20,0	17,5	10	7,2	
	IMOPLF0401		G1/8"	7,0	23,0	17,5	14	13,9	
	IMOPLF0402		G1/4"	9,0	25,0	17,5	17	18,2	
	IMOPLF06M5	6	M5x0,8	4,5	20,7	19,0	12	10,6	
	IMOPLF06M6		M6x1,0	5,0	21,2	19,0	12	10,4	
	IMOPLF0601		G1/8"	7,0	24,4	19,0	14	16,4	
	IMOPLF0602		G1/4"	9,0	26,4	19,0	17	21,3	
	IMOPLF0603	6	G3/8"	10,0	27,7	19,0	19	30,0	
	IMOPLF0801		8	G1/8"	7,0	27,3	22,8	14	19,4
	IMOPLF0802			G1/4"	9,0	29,5	22,8	17	24,1
	IMOPLF0803			G3/8"	10,0	31,0	22,8	19	32,4
	IMOPLF0804	G1/2"		12,0	33,0	22,8	24	41,6	
	IMOPLF1001	10	G1/8"	7,0	27,3	26,3	17	27,7	
	IMOPLF1002		G1/4"	9,0	33,8	26,3	17	33,8	
	IMOPLF1003		G3/8"	10,0	35,3	26,3	19	34,3	
	IMOPLF1004		G1/2"	12,0	37,8	26,3	24	51,2	
	IMOPLF1202	12	G1/4"	9,0	29,0	29,6	21	36,7	
	IMOPLF1203		G3/8"	10,0	37,0	29,6	21	49,2	
	IMOPLF1204		G1/2"	12,0	39,5	29,6	24	54,7	

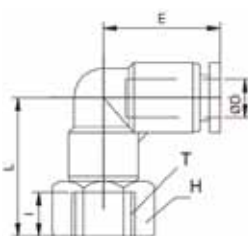

Codo orientable 45° rosca macho cónica BSPT niquelado • Male elbow 45° BSPT thread nickel plated

IMOPL45	REFERENCIA	ØD	T	I	L	E	H (Hex)	Peso Weight(g)
	IMOPL450401	4	R1/8"	7,0	22,2	16,2	10	8,0
	IMOPL450402		R1/4"	9,5	25,7	16,2	14	13,8
	IMOPL450601	6	R1/8"	7,0	23,9	17,7	12	11,0
	IMOPL450602		R1/4"	9,5	26,9	17,7	14	16,0
	IMOPL450603		R3/8"	10,5	28,4	17,7	17	22,2
	IMOPL450604		R1/2"	13,5	31,9	17,7	21	35,4
	IMOPL450801	8	R1/8"	7,0	27,1	20,9	14	17,3
	IMOPL450802		R1/4"	9,5	29,6	20,9	14	17,4
	IMOPL450803		R3/8"	10,5	31,1	20,9	17	25,0
	IMOPL450804		R1/2"	13,5	34,6	20,9	21	37,9
	IMOPL451001	10	R1/8"	7,0	29,7	22,2	17	30,0
	IMOPL451002		R1/4"	9,5	32,2	22,2	17	30,7
IMOPL451003	R3/8"		10,5	33,2	22,2	17	30,1	
IMOPL451004	R1/2"		13,5	36,7	22,2	21	46,6	
IMOPL451202	12	R1/4"	9,5	35,2	26,3	21	42,6	
IMOPL451203		R3/8"	10,5	36,2	26,3	21	45,0	
IMOPL451204		R1/2"	13,5	39,2	26,3	21	49,5	

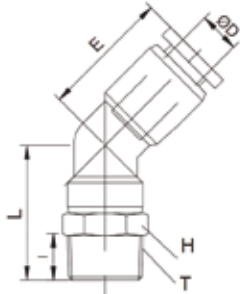

Codo orientable 45° rosca macho cilíndrica BSPP y métrica niquelado • Male elbow 45° BSPP & metric thread nickel plated

IMOPL45-G	REFERENCIA	ØD	T	I	L	E	H (Hex)	Peso Weight(g)
	IMOPL4504M5	4	M5x0,8	3,8	20,0	16,2	10	8,1
	IMOPL4504M6		M6x1,0	4,5	20,7	16,2	10	8,3
	IMOPL4504-G01		G1/8"	5,0	22,7	16,2	14	11,7
	IMOPL4504-G02		G1/4"	5,8	24,0	16,2	17	17,8
	IMOPL4506M5	6	M5x0,8	3,8	21,7	17,7	12	10,8
	IMOPL4506M6		M6x1,0	4,5	22,4	17,7	12	11,5
	IMOPL4506-G01		G1/8"	5,0	23,9	17,7	14	14,2
	IMOPL4506-G02		G1/4"	5,8	25,2	17,7	17	17,5
	IMOPL4506-G03	8	G3/8"	6,8	26,7	17,7	20	24,0
	IMOPL4506-G04		G1/2"	8,0	27,9	17,7	24	38,0
	IMOPL4508-G01		G1/8"	5,0	26,6	20,9	14	17,2
	IMOPL4508-G02		G1/4"	5,8	27,9	20,9	17	20,2
	IMOPL4508-G03	10	G3/8"	6,8	29,4	20,9	20	26,3
	IMOPL4508-G04		G1/2"	8,0	30,6	20,9	24	36,5
	IMOPL4510-G01		G1/8"	5,0	29,2	22,2	17	30,6
	IMOPL4510-G02		G1/4"	5,8	30,0	22,2	17	29,9
	IMOPL4510-G03	12	G3/8"	6,8	31,5	22,2	20	34,0
	IMOPL4510-G04		G1/2"	8,0	33,7	22,2	24	46,7
	IMOPL4512-G02		G1/4"	5,8	33,5	26,3	21	42,4
	IMOPL4512-G03		G3/8"	6,8	34,5	26,3	21	43,0
IMOPL4512-G04	G1/2"	8,0	36,2	26,3	24	50,3		

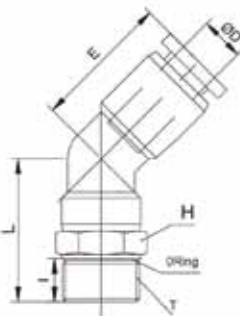

Codo orientable rosca macho cónica BSPT tipo banjo niquelado • Swivel male banjo elbow BSPT thread nickel plated

IMOPH	REFERENCIA	ØD	T	I	L	E	H (Hex)	Peso Weight(g)
	IMOPH0401	4	R1/8"	7,0	23,0	22,3	10	10,5
	IMOPH0402		R1/4"	9,5	26,3	24,1	14	21,9
	IMOPH0601	6	R1/8"	7,0	23,0	23,1	10	11,0
	IMOPH0602		R1/4"	9,5	26,3	25,1	14	22,5
	IMOPH0603		R3/8"	10,5	31,9	26,8	19	37,8
	IMOPH0801		R1/8"	7,0	23,0	25,6	10	11,8
	IMOPH0802	8	R1/4"	9,5	26,3	28,6	14	23,3
	IMOPH0803		R3/8"	10,5	31,9	29,6	19	38,4
	IMOPH0804		R1/2"	13,5	38,6	32,6	24	75,4
	IMOPH1002		R1/4"	9,5	26,3	31,0	14	26,7
	IMOPH1003	10	R3/8"	10,5	31,9	31,6	19	41,8
	IMOPH1004		R1/2"	13,5	38,6	34,6	24	78,8
IMOPH1202	R1/4"		9,5	26,3	33,5	14	28,2	
IMOPH1203	R3/8"		10,5	31,9	35,6	19	43,4	
IMOPH1204	R1/2"	13,5	38,6	36,6	24	80,3		



Codo orientable rosca macho cilíndrica BSPP y métrica tipo banjo niquelado • Swivel male banjo elbow BSPP & metric thread nickel plated

IMOPH-G	REFERENCIA	ØD	T	I	L	E	H (Hex)	Peso Weight(g)
	IMOPH04M5	4	M5x0,8	4,0	18,0	20,0	8	6,6
	IMOPH04M6		M6x1,0	4,5	18,5	20,0	8	11,8
	IMOPH04-G01		G1/8"	5,0	22,5	22,3	10	11,5
	IMOPH06M5	6	M5x0,8	4,0	18,0	21,9	8	7,2
	IMOPH06M6		M6x1,0	4,5	18,5	21,9	8	12,4
	IMOPH06-G01		G1/8"	5,0	22,5	23,1	10	12,0
	IMOPH06-G02	G1/4"	5,8	26,2	25,1	14	23,0	
	IMOPH08-G01	8	G1/8"	5,0	22,5	25,6	10	12,8
	IMOPH08-G02		G1/4"	5,8	26,2	28,6	14	23,8
	IMOPH08-G03		G3/8"	6,8	31,7	29,6	19	40,9
	IMOPH10-G02	10	G1/4"	5,8	26,2	31,1	14	27,2
	IMOPH10-G03		G3/8"	6,8	31,7	31,6	19	44,3
IMOPH12-G03	12	G3/8"	6,8	31,7	35,6	19	45,9	
IMOPH12-G04		G1/2"	8,0	37,1	36,6	24	79,3	

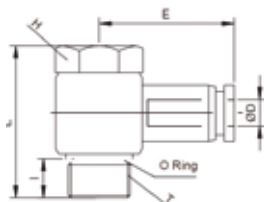

Codo orientable rosca macho cónica BSPT - hembra tipo banjo niquelado • Swivel female banjo elbow BSPT thread

IMOPHF	REFERENCIA	ØD	T1	T2	I1	I2	L	E	H (Hex)	Peso Weight(g)
	IMOPHF0401	4	G1/8"	R1/8"	7,0	7,0	29,0	22,3	14	16,4
	IMOPHF0402		G1/4"	R1/4"	9,5	9,0	33,3	24,1	17	27,4
	IMOPHF0601	6	G1/8"	R1/8"	7,0	7,0	29,0	23,1	14	17,0
	IMOPHF0602		G1/4"	R1/4"	9,5	9,0	33,3	25,1	17	28,0
	IMOPHF0603		G3/8"	R3/8"	10,5	10,0	39,9	26,8	19	44,8
	IMOPHF0801	8	G1/8"	R1/8"	7,0	7,0	29,0	25,6	14	17,8
	IMOPHF0802		G1/4"	R1/4"	9,5	9,0	33,3	28,6	17	28,8
	IMOPHF0803		G3/8"	R3/8"	10,5	10,0	39,9	29,6	19	45,4
	IMOPHF0804		G1/2"	R1/2"	13,5	12,0	46,5	32,6	24	71,9
	IMOPHF1002	10	G1/4"	R1/4"	9,5	9,0	33,3	31,0	17	32,2
	IMOPHF1003		G3/8"	R3/8"	10,5	10,0	39,9	31,6	19	48,8
	IMOPHF1004		G1/2"	R1/2"	13,5	12,0	46,5	34,6	24	75,3
	IMOPHF1202	12	G1/4"	R1/4"	9,5	9,0	33,3	33,5	17	33,7
	IMOPHF1203		G3/8"	R3/8"	10,5	10,0	39,9	35,6	19	50,4
IMOPHF1204	G1/2"		R1/2"	13,5	12,0	46,5	36,6	24	76,8	

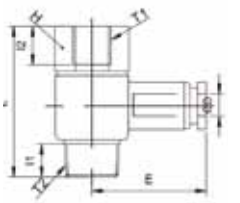

Codo orientable rosca macho cilíndrica BSPP y métrica tipo banjo niquelado • Swivel female banjo elbow BSPP & metric thread nickel plated

IMOPHF-G	REFERENCIA	ØD	T1	T2	I1	I2	L	E	H (Hex)	Peso Weight(g)
	IMOPHF04M5	4	M5x0,8	M5x0,8	4,0	5,5	20,5	20,0	10	8,3
	IMOPHF04M6		M6x1,0	M6x1,0	4,5	6,0	21,0	20,0	10	8,3
	IMOPHF04-G01		G1/8"	G1/8"	5,7	7,0	29,0	22,3	14	18,4
	IMOPHF06M5	6	M5x0,8	M5x0,8	4,0	5,5	20,5	21,9	10	8,9
	IMOPHF06M6		M6x1,0	M6x1,0	4,5	7,0	30,0	23,1	14	8,9
	IMOPHF06-G01		G1/8"	G1/8"	5,5	7,0	30,0	23,1	14	19,0
	IMOPHF06-G02	G1/4"	G1/4"	6,5	9,0	33,7	25,1	17	30,5	
	IMOPHF08-G01	8	G1/8"	G1/8"	5,5	7,0	30,0	25,6	14	19,8
	IMOPHF08-G02		G1/4"	G1/4"	6,5	9,0	33,7	28,6	17	31,3
	IMOPHF08-G03		G3/8"	G3/8"	7,5	10,0	39,7	29,6	19	47,9
	IMOPHF10-G02	10	G1/4"	G1/4"	6,5	9,0	33,7	31,1	17	34,7
	IMOPHF10-G03		G3/8"	G3/8"	7,5	10,0	39,7	31,6	19	51,3
	IMOPHF12-G03	12	G3/8"	G3/8"	7,5	10,0	39,7	25,6	19	52,9
	IMOPHF12-G04		G1/2"	G1/2"	9,0	12,0	45,0	36,6	24	77,3

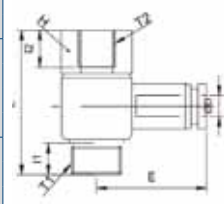

“T” Orientable rosca central macho cónica BSPT niquelado • Swivel male central tee BSPT thread nickel plated

IMOPT	REFERENCIA	ØD	T	I	L	E	H (Hex)	Peso Weight(g)
	IMOPT0401	4	R1/8"	7,0	24,5	18,5	10	10,5
	IMOPT0402		R1/4"	9,5	28,0	18,5	14	16,3
	IMOPT0601	6	R1/8"	7,0	25,5	19,3	12	14,1
	IMOPT0602		R1/4"	9,5	28,5	19,3	14	19,1
	IMOPT0603		R3/8"	10,5	30,0	19,3	17	25,2
	IMOPT0604		R1/2"	13,5	33,5	19,3	21	38,5
	IMOPT0801	8	R1/8"	7,0	29,0	22,8	14	20,9
	IMOPT0802		R1/4"	9,5	31,5	22,8	14	21,0
	IMOPT0803		R3/8"	10,5	32,0	22,8	17	28,6
	IMOPT0804		R1/2"	13,5	36,5	22,8	21	41,5
	IMOPT1001	10	R1/8"	7,0	34,5	27,0	17	37,9
	IMOPT1002		R1/4"	9,5	37,0	27,0	17	38,6
	IMOPT1003		R3/8"	10,5	38,0	27,0	17	38,0
	IMOPT1004		R1/2"	13,5	41,5	27,0	21	54,5
	IMOPT1202	12	R1/4"	9,5	38,5	29,6	21	52,8
	IMOPT1203		R3/8"	10,5	39,5	29,6	21	55,2
IMOPT1204	R1/2"		13,5	42,5	29,6	21	59,7	
IMOPT1603	16	R3/8"	10,5	43,0	33,0	24	81,0	
IMOPT1604		R1/2"	13,5	46,0	33,0	24	85,5	



“T” Orientable rosca central macho cilíndrica BSPP y métrica niquelado • Swivel male central tee BSPP & metric thread nickel plated

IMOPT-G	REFERENCIA	ØD	T	I	L	E	H (Hex)	Peso Weight(g)
	IMOPT04M5	4	M5x0,8	3,8	22,3	18,5	10	10,6
	IMOPT04M6		M6x1,0	4,5	23,0	18,5	10	10,8
	IMOPT04-G01		G1/8"	5,0	25,0	18,5	14	14,2
	IMOPT04-G02		G1/4"	5,8	26,3	18,5	17	20,3
	IMOPT06M5	6	M5x0,8	3,8	23,3	19,3	12	13,9
	IMOPT06M6		M6x1,0	4,5	24,0	19,3	12	14,6
	IMOPT06-G01		G1/8"	5,0	25,5	19,3	14	17,2
	IMOPT06-G02		G1/4"	5,8	26,8	19,3	17	20,5
	IMOPT06-G03	8	G3/8"	6,8	28,3	19,3	20	27,0
	IMOPT06-G04		G1/2"	8,0	29,5	19,3	24	41,0
	IMOPT08-G01		G1/8"	5,0	28,5	22,8	14	20,8
	IMOPT08-G02		G1/4"	5,8	29,8	22,8	17	23,8
	IMOPT08-G03	10	G3/8"	6,8	31,3	22,8	20	29,9
	IMOPT08-G04		G1/2"	8,0	32,5	22,8	24	40,1
	IMOPT10-G01		G1/8"	5,0	34,0	27,0	17	38,4
	IMOPT10-G02		G1/4"	5,8	34,8	27,0	17	37,7
	IMOPT10-G03	12	G3/8"	6,8	36,3	27,0	20	41,8
	IMOPT10-G04		G1/2"	8,0	38,5	27,0	24	54,5
	IMOPT12-G02		G1/4"	5,8	36,8	29,6	21	52,4
	IMOPT12-G03		G3/8"	6,8	37,8	29,6	21	53,0
	IMOPT12-G04	14	G1/2"	8,0	39,5	29,6	24	60,3
	IMOPT14-G03		G3/8"	6,8	39,8	31,7	21	61,0
	IMOPT14-G04		G1/2"	8,0	41,5	31,7	24	69,0
	IMOPT16-G03		16	G3/8"	6,8	40,8	33,0	24
	IMOPT16-G04	G1/2"		8,0	42,0	33,0	24	79,4

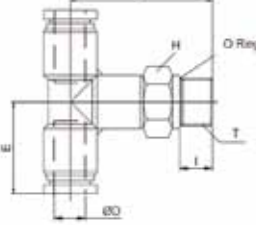

““T” Orientable rosca lateral macho cónica BSPT niquelado • Swivel lateral male tee BSPT thread nickel plated

IMOPST	REFERENCIA	ØD	T	I	L	E	H (Hex)	Peso Weight(g)
	IMOPST0401	4	R1/8"	7,0	24,5	18,5	10	10,5
	IMOPST0402		R1/4"	9,5	28,0	18,5	14	16,3
	IMOPST0601	6	R1/8"	7,0	25,5	19,3	12	14,1
	IMOPST0602		R1/4"	9,5	28,5	19,3	14	19,1
	IMOPST0603		R3/8"	10,5	30,0	19,3	17	25,2
	IMOPST0604		R1/2"	13,5	33,5	19,3	21	38,5
	IMOPST0801	8	R1/8"	7,0	29,0	22,8	14	20,9
	IMOPST0802		R1/4"	9,5	31,5	22,8	14	21,0
	IMOPST0803		R3/8"	10,5	32,3	22,8	17	28,6
	IMOPST0804		R1/2"	13,5	36,5	22,8	21	41,5
	IMOPST1001	10	R1/8"	7,0	34,5	27,0	17	37,9
	IMOPST1002		R1/4"	9,5	37,0	27,0	17	38,6
	IMOPST1003		R3/8"	10,5	38,0	27,0	17	38,0
	IMOPST1004		R1/2"	13,5	41,5	27,0	21	54,5
	IMOPST1202	12	R1/4"	9,5	38,5	29,6	21	52,8
	IMOPST1203		R3/8"	10,5	39,5	29,6	21	55,2
	IMOPST1204		R1/2"	13,5	42,5	29,6	21	59,7



"T" Orientable rosca lateral macho cilíndrica BSPP y métrica niquelado • Swivel male central tee BSPP & metric thread nickel plated

IMOPST-G	REFERENCIA	ØD	T	I	L	E	H(Hex)	Peso Weight(g)
	IMOPST04M5	4	M5x0,8	3,8	22,3	18,5	10	10,6
	IMOPST04M6		M6x1,0	4,5	23,0	18,5	10	10,8
	IMOPST04-G01		G1/8"	5,0	25,0	18,5	14	14,2
	IMOPST04-G02		G1/4"	5,8	26,3	18,5	17	20,3
	IMOPST06M5	6	M5x0,8	3,8	23,3	19,3	12	13,9
	IMOPST06M6		M6x1,0	4,5	24,0	19,3	12	14,6
	IMOPST06-G01		G1/8"	5,0	25,5	19,3	14	17,2
	IMOPST06-G02		G1/4"	5,8	26,8	19,3	17	20,5
	IMOPST06-G03	G3/8"	6,8	28,3	19,3	20	27,0	
	IMOPST06-G04	G1/2"	8,0	29,5	19,3	24	41,0	
	IMOPST08-G01	8	G1/8"	5,0	28,5	22,8	14	20,8
	IMOPST08-G02		G1/4"	5,8	29,8	22,8	17	23,8
	IMOPST08-G03		G3/8"	6,8	31,3	22,8	20	29,9
	IMOPST08-G04		G1/2"	8,0	32,5	22,8	24	40,1
	IMOPST10-G01	10	G1/8"	5,0	34,0	27,0	17	38,4
	IMOPST10-G02		G1/4"	5,8	34,8	27,0	17	37,7
IMOPST10-G03	G3/8"		6,8	36,3	27,0	20	41,8	
IMOPST10-G04	G1/2"		8,0	38,5	27,0	24	54,5	
IMOPST12-G02	12	G1/4"	5,8	36,8	29,6	21	52,4	
IMOPST12-G03		G3/8"	6,8	37,8	29,6	21	53,0	
IMOPST12-G04		G1/2"	8,0	39,5	29,6	24	60,3	

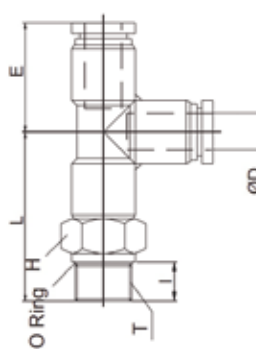

"Y" Orientable rosca macho cónica BSPT niquelado • Swivel male Y BSPT thread nickel plated

IMOPWT	REFERENCIA	ØD	T	I	L	E	H(Hex)	Peso Weight(g)
	IMOPWT0401	4	R1/8"	7,0	41,5	14,0	10	10,7
	IMOPWT0402		R1/4"	9,5	45,0	14,0	14	16,6
	IMOPWT0601		R1/8"	7,0	43,3	14,8	12	14,6
	IMOPWT0602		R1/4"	9,5	46,3	14,8	14	19,6
	IMOPWT0603	R3/8"	10,5	47,8	14,8	17	25,8	
	IMOPWT0604	R1/2"	13,5	51,3	14,8	21	39,0	
	IMOPWT0801	8	R1/8"	7,0	46,6	18,2	14	21,0
	IMOPWT0802		R1/4"	9,5	49,1	18,2	14	21,1
	IMOPWT0803		R3/8"	10,5	50,6	18,2	17	28,7
	IMOPWT0804		R1/2"	13,5	54,1	18,2	21	41,6
	IMOPWT1001	10	R1/8"	7,0	54,6	19,5	17	38,3
	IMOPWT1002		R1/4"	9,5	57,1	19,5	17	39,0
	IMOPWT1003		R3/8"	10,5	58,1	19,5	17	38,4
	IMOPWT1004		R1/2"	13,5	61,6	19,5	21	54,9
	IMOPWT1202	12	R1/4"	9,5	62,1	21,6	21	53,6
	IMOPWT1203		R3/8"	10,5	63,1	21,6	21	46,0
IMOPWT1204	R1/2"		13,5	66,1	21,6	21	60,5	

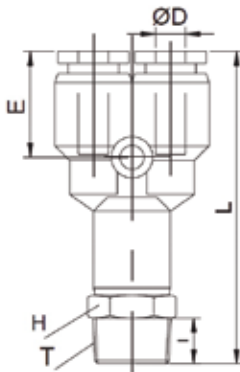

"Y" Orientable rosca macho cilíndrica BSPP y métrica niquelado • Swivel male Y BSPP & metric thread nickel plated

IMOPWT-G	REFERENCIA	ØD	T	I	L	E	H(Hex)	Peso Weight(g)
	IMOPWT04M5	4	M5x0,8	3,8	39,3	14,0	10	10,8
	IMOPWT04M6		M6x1,0	4,5	40,0	14,0	10	11,0
	IMOPWT04-G01		G1/8"	5,0	42,0	14,0	14	14,5
	IMOPWT04-G02		G1/4"	5,8	43,3	14,0	14	20,6
	IMOPWT06M5	6	M5x0,8	3,8	41,1	14,8	12	14,5
	IMOPWT06M6		M6x1,0	4,5	41,8	14,8	12	15,1
	IMOPWT06-G01		G1/8"	5,0	43,3	14,8	14	17,7
	IMOPWT06-G02		G1/4"	5,8	44,6	14,8	17	21,0
	IMOPWT06-G03	G3/8"	6,8	46,1	14,8	20	27,5	
	IMOPWT06-G04	G1/2"	8,0	47,3	14,8	24	41,5	
	IMOPWT08-G01	8	G1/8"	5,0	46,1	18,2	14	20,9
	IMOPWT08-G02		G1/4"	5,8	47,4	18,2	17	23,9
	IMOPWT08-G03		G3/8"	6,8	48,9	18,2	20	30,0
	IMOPWT08-G04		G1/2"	8,0	50,1	18,2	24	40,2
	IMOPWT10-G01	10	G1/8"	5,0	54,1	19,5	17	38,8
	IMOPWT10-G02		G1/4"	5,8	54,9	19,5	17	38,1
IMOPWT10-G03	G3/8"		6,8	56,4	19,5	20	42,2	
IMOPWT10-G04	G1/2"		8,0	58,6	19,5	24	54,9	
IMOPWT12-G02	12	G1/4"	5,8	60,4	21,6	21	53,2	
IMOPWT12-G03		G3/8"	6,8	61,4	21,6	21	53,8	
IMOPWT12-G04		G1/2"	8,0	63,1	21,6	24	61,1	

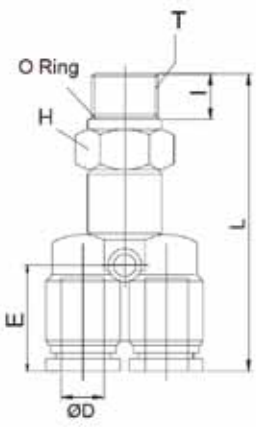

Distribuidor múltiple tubo rosca macho cónica BSPT niquelado • Swivel multi-tee lateral male connector BSPT thread

IMOPKD	REFERENCIA	ØD1	ØD2	T	I	L	E	F	H (Hex)	Peso Weight(g)
	IMOPKD0604-01	6	4	R1/8"	7,0	63,8	19,0	36,0	12	17,4
	IMOPKD0804-02	8	4	R1/4"	9,5	71,3	20,0	42,0	14	23,1
	IMOPKD0806-02		6	R1/4"	9,5	71,3	20,3	42,0	14	24,2
	IMOPKD1008-03	10	8	R3/8"	10,5	91,0	24,3	48,0	17	40,2

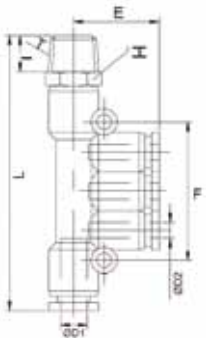

Distribuidor múltiple tubo rosca macho cilíndrica BSPP niquelado • Swivel multi-tee lateral male connector BSPP thread nickel plated

IMOPKD-G	REFERENCIA	ØD1	ØD2	Ød	T	I	L	E	F	H (Hex)	Peso Weight(g)
	IMOPKD0604-G01	6	4	3,2	G1/8"	5,0	63,8	19,0	36,0	14	20,5
	IMOPKD0804-G02	8	4	3,2	G1/4"	5,8	69,6	20,0	42,0	17	26,0
	IMOPKD0806-G02		6	3,2	G1/4"	5,8	69,6	20,3	42,0	17	27,0
	IMOPKD1008-G03	10	8	4,2	G3/8"	6,8	89,3	24,3	48,0	20	44,0

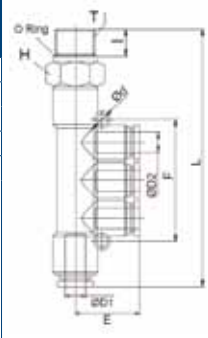

Unión tubo-tubo • Union connector

IMOPUC	REFERENCIA	ØD	L	Peso Weight(g)
	IMOPUC04	4	33,0	4,2
	IMOPUC05	5	35,2	5,0
	IMOPUC06	6	35,2	5,2
	IMOPUC07	7	39,1	7,0
	IMOPUC08	8	39,1	6,8
	IMOPUC09	9	45,2	14,0
	IMOPUC10	10	45,2	14,0
	IMOPUC11	11	49,2	17,0
	IMOPUC12	12	49,2	16,4
	IMOPUC14	14	48,4	18,0
	IMOPUC15	15	51,0	25,0
	IMOPUC16	16	51,0	24,5

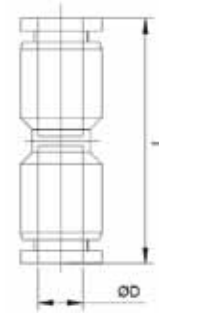

Reducción tubo-tubo • Reduced union connector

IMOPG	REFERENCIA	ØD1	ØD2	L	Peso Weight(g)
	IMOPG0604	6	4	33,6	5,2
	IMOPG0805	8	5	35,5	6,0
	IMOPG0806		6	36,1	6,8
	IMOPG1007	10	7	41,8	10,0
	IMOPG1008		8	41,8	12,7
	IMOPG1207	12	7	46,9	13,0
	IMOPG1208		8	46,9	14,1
	IMOPG1210	10	10	46,1	16,6
	IMOPG1410		14	10	46,7
	IMOPG1412	12		48,3	17,0
	IMOPG1610	16	10	48,5	24,3
	IMOPG1612		12	50,1	26,0
IMOPG1614	14	50,0	28,0		

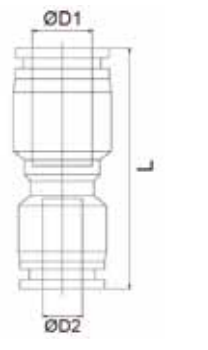

Codo tubo-tubo • Union elbow

IMOPUL	REFERENCIA	ØD1	Ød	E	Peso Weight(g)
	IMOPUL04	4	3,2	17,5	4,2
	IMOPUL06	6	3,2	19,0	5,5
	IMOPUL08	8	3,2	22,8	7,3
	IMOPUL10	10	4,2	26,3	14,3
	IMOPUL12	12	4,3	29,6	18,2
	IMOPUL14	14	5,1	31,7	23,0
	IMOPUL16	16	5,1	33,0	27,0

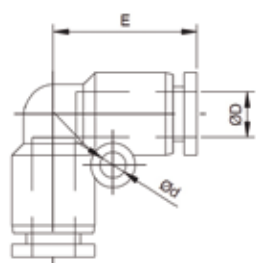

" T " Tubo • Union tee

IMOPUT	REFERENCIA	ØD1	Ød	E	Peso Weight(g)
	IMOPUT04	4	3,2	18,5	6,5
	IMOPUT06	6	3,2	19,3	8,1
	IMOPUT08	8	3,2	22,8	10,6
	IMOPUT10	10	4,2	27,0	21,4
	IMOPUT12	12	4,3	29,6	26,7
	IMOPUT14	14	5,1	31,7	31,0
	IMOPUT16	16	5,1	33,0	39,7

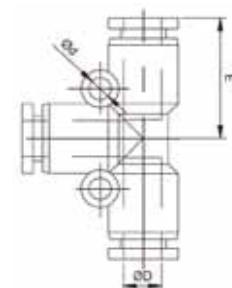

Reducción "T" tubo • Reduced union connector

IMOPGT	REFERENCIA	ØD1	ØD2	Ød	E	L	Peso Weight(g)
	IMOPGT06	6	4	3,2	19,5	38,6	8,1
	IMOPGT08	8	6	3,2	20,3	45,5	10,6
	IMOPGT10	10	8	4,2	24,8	54,0	20,2
	IMOPGT12	12	10	4,2	28,5	59,2	26,9
	IMOPGT16	16	12	5,1	32,1	66,0	41,9

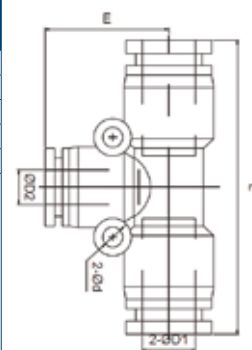

"Y" Unión tubo-tubo • Union Y

IMOPY	REFERENCIA	ØD1	Ød	L	F	Peso Weight(g)
	IMOPY04	4	3,2	35,5	14,0	6,8
	IMOPY06	6	3,2	37,1	14,8	8,6
	IMOPY08	8	3,2	40,4	18,2	10,7
	IMOPY10	10	4,2	47,1	19,5	21,8
	IMOPY12	12	4,2	53,2	21,6	27,5
	IMOPY16	16	5,1	61,0	23,5	33,5

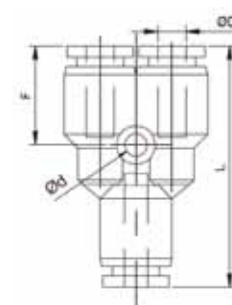

Reducción "Y" tubo-tubo • Reduced union Y

IMOPW	REFERENCIA	ØD1	ØD2	Ød	L	F	Peso Weight(g)
	IMOPW0604	6	4	3,2	36,8	14,5	9,2
	IMOPW0806	8	6	3,2	39,9	17,7	11,4
	IMOPW1008	10	8	4,2	47,9	20,3	21,8
	IMOPW1210	12	10	4,2	51,6	20,0	29,3

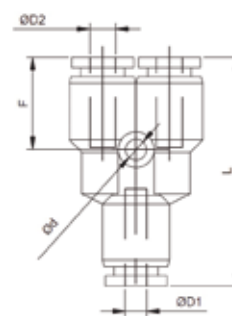

Cruz tubo • Cross junction

IMOPZA	REFERENCIA	ØD1	Ød	E	Peso Weight(g)
	IMOPZA04	4	3,2	17,5	8,0
	IMOPZA06	6	3,2	19,3	10,2
	IMOPZA08	8	3,2	22,8	13,6
	IMOPZA10	10	4,2	27,0	28,2
	IMOPZA12	12	4,3	29,6	34,2

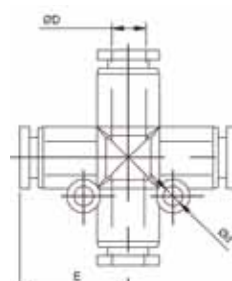

Distribuidor múltiple tubo • Multi tee

IMOPK	REFERENCIA	ØD	L	F	E	Peso Weight(g)
	IMOPK04	4	57,0	36	19,0	13,0
	IMOPK06	6	61,6	42	20,3	17,0
	IMOPK08	8	81,6	48	24,3	22,0

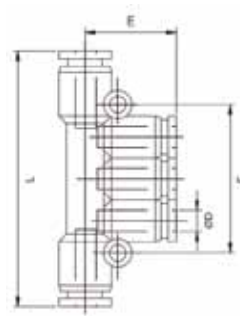

Distribuidor múltiple tubo reducido • Reduced multi tee

IMOPKG	REFERENCIA	ØD1	ØD2	Ød	L	E	F	Peso Weight(g)
	IMOPKG06-4	6	4	3,2	57,6	19,0	36	13,0
	IMOPKG08-4	8	4	3,2	62,6	20,0	42	16,0
	IMOPKG08-6		6	3,2	62,6	20,3	42	16,6
	IMOPKG10-6	10	6	4,2	80,0	23,8	48	28,0
	IMOPKG10-8		8	4,2	80,0	24,3	48	30,8

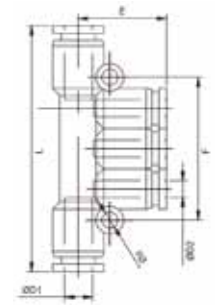

Distribuidor múltiple con espiga lateral • Multi-tee union with lateral stem

IMOPKJ	REFERENCIA	ESPIGA	ØD2	L	E	F	C	Peso Weight(g)
	IMOPKJ0604	6	4	74,8	19,0	36,0	18	17,0
	IMOPKJ0804	8	4	82,3	20,0	42,0	21	19,0
	IMOPKJ0806		6	82,3	20,3	42,0	21	23,4
	IMOPKJ1006	10	6	104,5	23,8	48,0	24	31,0
	IMOPKJ1008		8	104,5	24,3	48,0	24	39,7

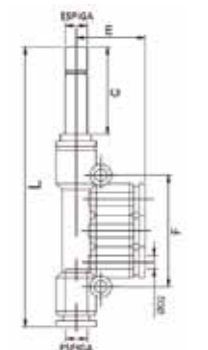

Codo con espiga • Elbow with stem

IMOPLJ	REFERENCIA	ØD	L	E	C	Peso Weight(g)
	IMOPLJ04	4	33,0	17,5	16,0	7,6
	IMOPLJ06	6	36,2	19,0	18,0	11,2
	IMOPLJ08	8	42,5	22,8	21,0	17,0
	IMOPLJ10	10	50,8	26,3	24,0	30,5
	IMOPLJ12	12	54,5	29,6	26,0	40,6

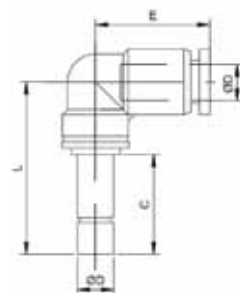

Codo con espiga reducida • Reduced elbow with stem

IMOPLGJ	REFERENCIA	ESPIGA	ØD2	L	E	C	Peso Weight(g)
	IMOPLGJ0604	6	4	35,0	17,5	18,0	8,7
	IMOPLGJ0806	8	6	39,2	19,0	21,0	13,7
	IMOPLGJ1008	10	8	46,5	22,8	24,0	19,4
	IMOPLGJ1210	12	10	52,8	26,3	26,0	34,6

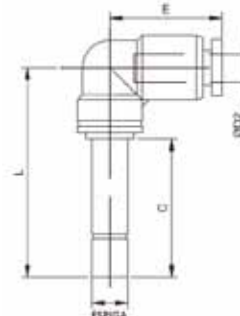

Unión "Y" con espiga • Union Y with stem



REFERENCIA	ØD	Ød	L	F	C	Peso Weight(g)
IMOPYJ04	4	3,2	51,0	14,0	16	10,2
IMOPYJ06	6	3,2	54,3	14,8	18	14,4
IMOPYJ08	8	3,2	60,1	18,2	21	20,4
IMOPYJ10	10	4,2	71,6	19,5	24	38,1
IMOPYJ12	12	4,2	78,1	21,6	26	49,9

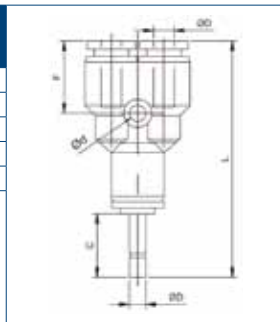

Unión "Y" con espiga reducida • Reduced union Y with stem



REFERENCIA	ESPIGA	TUBO	Ød	L	F	C	Peso Weight(g)
IMOPWJ0604	6	4	3,2	53,0	14,0	18	14,5
IMOPWJ0806	8	6	3,2	57,3	14,8	21	20,4
IMOPWJ1008	10	8	4,2	64,1	18,2	24	35,5
IMOPWJ1210	12	10	4,2	73,6	19,5	26	50,5

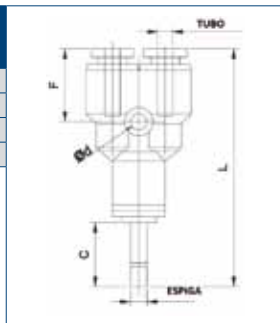

Reducción • Reducer



REFERENCIA	ESPIGA	TUBO	L	C	Peso Weight(g)
IMOPGJ0604	6	4	39,5	14,0	1,4
IMOPGJ0804	8	4	41,5	14,0	2,7
IMOPGJ0806	6	6	41,8	14,3	2,0
IMOPGJ1006	10	6	46,8	17,3	3,8
IMOPGJ1008	8	8	47,3	17,8	2,8
IMOPGJ1206	12	6	51,8	19,3	7,7
IMOPGJ1208	8	8	52,3	19,8	6,4
IMOPGJ1210	10	10	51,5	19,0	4,2

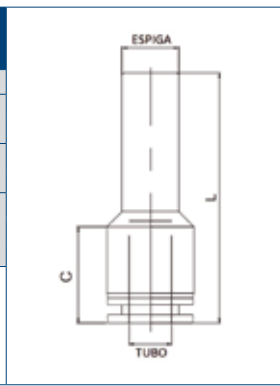

Unión lisa • Junction



REFERENCIA	ØD	L	Peso Weight(g)
IMOPIJ04	4	35	0,4
IMOPIJ06	6	37	0,8
IMOPIJ08	8	41	1,2
IMOPIJ10	10	51	2,7
IMOPIJ12	12	54	3,5
IMOPIJ16	16	58	5,3

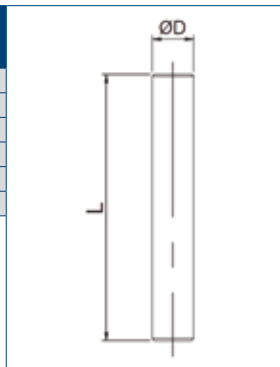

Unión reducción • Reduced junction

IMOPIG	REFERENCIA	ØD1	ØD2	C1	C2	L	Peso Weight(g)
	IMOPIG0604	6	4	18	17	36	0,6
	IMOPIG0806	8	6	20	18	39	1,0
	IMOPIG1008	10	8	25	20	46	1,9
	IMOPIG1210	12	10	27	26	54	3,2
	IMOPIG1612	16	12	28	28	56	4,8

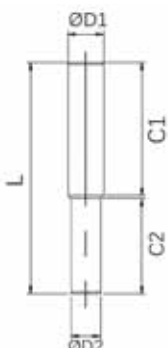

Tapón macho • Male plug

IMOPP	REFERENCIA	ØD	L	ØP1	ØP2	C	Peso Weight(g)
	IMOPP04	4	28	5,0	3,0	15,0	0,4
	IMOPP06	6	33	7,0	3,0	17,0	0,8
	IMOPP08	8	37	9,0	4,0	18,0	1,3
	IMOPP10	10	42	11,0	5,0	20,5	2,2
	IMOPP12	12	44	13,0	6,0	23,0	3,1

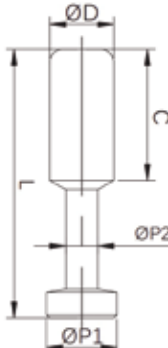

Tapón hembra • Female plug

IMOPPF	REFERENCIA	ØD	L	Peso Weight(g)
NUEVO 	IMOPPF04	4	17,5	2,6
	IMOPPF05	5	17,5	3,1
	IMOPPF06	6	17,5	3,7
	IMOPPF07	7	20,8	3,8
	IMOPPF08	8	20,8	4,2
	IMOPPF10	10	25,3	5,5
	IMOPPF12	12	25,6	9,3
	IMOPPF14	14	25,7	12,4
	IMOPPF15	15	27,0	15,3
	IMOPPF16	16	27,0	17,1

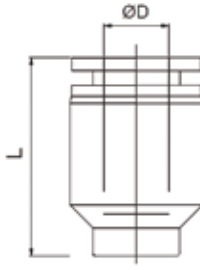

ESPECIALES

SPECIAL PUSH IN FITTINGS

Conexión rosca macho cónica BSPT • Male plug BSPT thread

HPC	REFERENCIA	ØD	T	A	B	ØE	L	H (Hex)	Peso Weight(g)
NUEVO 	HPC06R01B	6	R1/8"	9,1	16,1	18,5	26,2	17	4,0
	HPC06R02B		R1/4"	13,1	16,1	18,5	26,7	17	4,2
	HPC08R01B	8	R1/8"	9,1	17,5	21,0	28,1	19	5,3
	HPC08R02B		R1/4"	13,1	17,5	21,0	30,6	19	5,8
	HPC10R03B	10	R3/8"	13,5	20,1	23,2	28,8	21	6,7
	HPC10R04B		R1/2"	16,3	20,1	24,4	32,1	22	9,5
	HPC12R03B	12	R3/8"	13,5	24,7	26,5	32,2	24	8,8
	HPC12R04B		R1/2"	16,3	24,7	26,5	34,3	24	11,1

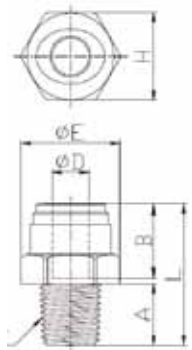

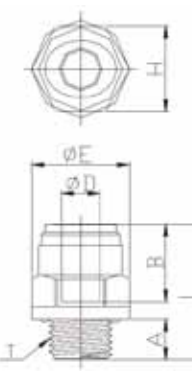

Conexión rosca macho cilíndrica BSPP • Male plug BSPP thread

HPC-G	REFERENCIA	ØD	T	A	B	ØE	L	H (Hex)	Peso Weight(g)
NUEVO 	HPC04G01B	4	G1/8"	6,0	14,7	16,6	21,9	15	3,3
	HPC04G02B		G1/4"	8,5	14,7	20,5	23,9	18	4,8
	HPC06G01B	6	G1/8"	6,0	16,1	16,6	24,1	15	3,3
	HPC06G02B		G1/4"	8,5	16,1	20,5	24,1	18	4,5
	HPC08G01B	8	G1/8"	6,0	17,5	18,5	27,0	17	5,2
	HPC08G02B		G1/4"	8,5	17,5	20,5	28,5	18	6,1
	HPC08G03B		G3/8"	9,0	17,5	24,0	26,5	21	7,0
	HPC08G04B		G1/2"	12,5	17,5	28,5	29,5	26	11,9
	HPC10G02B	10	G1/4"	8,5	17,5	24,1	30,8	19	7,2
	HPC10G03B		G3/8"	9,0	20,1	24,2	26,3	21	7,0
	HPC10G04B	12	G1/2"	12,5	20,1	28,5	29,8	26	7,9
	HPC12G03B		G3/8"	9,0	24,7	27,0	34,2	24	11,6
	HPC12G04B	G1/2"	12,5	24,7	28,5	32,7	26	12,5	



Adaptador con rosca macho cónica BSPT • Stem adapter BSPT thread

HCJ	REFERENCIA	ØD	T	A	B	ØE	L	H (Hex)	Peso Weight(g)
NUEVO 	HCJ04R01B	4	R1/8"	9,1	18,0	14,4	33,1	13	2,6
	HCJ04R02B		R1/4"	13,1	18,0	18,5	37,1	17	4,2
	HCJ06R01B	6	R1/8"	9,1	19,5	14,4	34,6	13	2,8
	HCJ06R02B		R1/4"	13,1	19,5	18,5	38,6	17	4,3
	HCJ08R01B	8	R1/8"	9,1	21,0	14,4	36,1	13	3,0
	HCJ08R02B		R1/4"	13,1	21,0	18,5	40,1	17	4,6
	HCJ08R03B		R3/8"	13,5	21,0	23,0	40,5	21	6,2
	HCJ10R02B		R1/4"	13,1	24,0	18,5	43,1	17	5,3
	HCJ10R03B	10	R3/8"	13,5	24,0	23,0	44,0	21	6,8
	HCJ10R04B		R1/2"	16,5	24,0	26,5	47,0	24	10,6
	HCJ12R03B	12	R3/8"	13,5	28,0	23,0	48,0	21	7,3
	HCJ12R04B		R1/2"	16,5	28,0	26,5	51,0	24	11,0



SPECIAL PUSH IN FITTINGS

ESPECIALES

Adaptador con rosca macho cilíndrica BSPP • Stem adapter BSPP thread

HCJ-G	REFERENCIA	ØD	T	A	B	ØE	L	H (Hex)	Peso Weight(g)
 <p>NUEVO</p>	HCJ04G01B	4	G1/8"	6,0	18,0	16,6	32,5	15	2,6
	HCJ04G02B		G1/4"	8,5	18,0	20,5	35,0	18	4,2
	HCJ06G01B	6	G1/8"	6,0	19,5	16,6	34,0	15	2,8
	HCJ06G02B		G1/4"	8,5	19,5	20,5	36,5	18	4,3
	HCJ08G01B	8	G1/8"	6,0	21,0	16,6	35,5	15	3,0
	HCJ08G02B		G1/4"	8,5	21,0	20,5	38,0	18	4,6
	HCJ08G03B		G3/8"	9,0	21,0	24,2	38,5	22	6,2
	HCJ10G02B	10	G1/4"	8,5	24,0	20,5	41,0	18	5,3
	HCJ10G03B		G3/8"	9,0	24,0	24,2	41,5	22	6,8
	HCJ10G04B	12	G1/2"	12,5	24,0	28,5	45,0	26	10,6
	HCJ12G03B		G3/8"	9,0	28,0	24,2	45,5	22	7,3
	HCJ12G04B		G1/2"	12,5	28,0	28,5	49,0	26	11,0

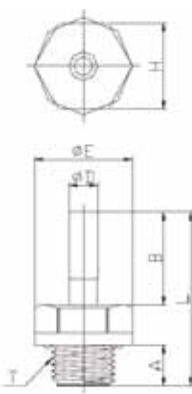

Unión recta tubo-tubo con fijación para perfil DIN o Ω • Union connector for DIN profile or Ω

IMOPUCPRD	REFERENCIA	ØD	A	L	C	Peso Weight(g)
	IMOPUCPRD04	4	34,6	45,0	22,0	8,0
	IMOPUCPRD06	6	35,2	45,0	22,0	8,0
	IMOPUCPRD08	8	39,1	45,0	22,7	10,0
	IMOPUCPRD10	10	45,2	45,0	24,7	17,0
	<p>Este tipo de racor hace más fácil la instalación y conexión de sistemas neumáticos. Es posible usar e insertar etiquetas identificativas sobre el racor.</p> <p>This type of fittings make easier the installation of pneumatic connections and systems. It's possible to use and insert labels for identification on the fittings</p>					

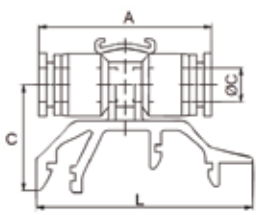

Anillo de colores • Applicable sleeve color

IMOPCV	REFERENCIA	ØA	B	ØC	ØD	Color Standard Standard colours	Peso Weight(g)
	IMOPCV04	4,3	2,4	10,1	11,0	●●●●●	0,10
	IMOPCV06	6,3	2,6	12,1	13,0	●●●●●	0,14
	<p>Aplicable solo sobre racores termoplásticos. Applicable only on thermoplastic fittings</p> <p>NOTA: Marcar el color detrás de la referencia: Ej. IMOPCV04-AM (Amarillo)</p>						

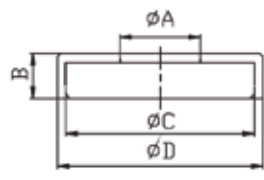

Designación Referencia - Model designation

IMOTC IMOTC	04 04	M5 01																																						
Código Code	Diámetro Tubo Tube diameter	Rosca Thread size																																						
	<table border="1"> <tr><th>Código</th><th>Tubo</th></tr> <tr><td>03</td><td>3mm</td></tr> <tr><td>04</td><td>4mm</td></tr> <tr><td>05</td><td>5mm</td></tr> <tr><td>06</td><td>6mm</td></tr> <tr><td>07</td><td>7mm</td></tr> <tr><td>08</td><td>8mm</td></tr> <tr><td>10</td><td>10mm</td></tr> <tr><td>12</td><td>12mm</td></tr> <tr><td>14</td><td>14mm</td></tr> </table>	Código	Tubo	03	3mm	04	4mm	05	5mm	06	6mm	07	7mm	08	8mm	10	10mm	12	12mm	14	14mm	<table border="1"> <tr><th colspan="2">Métrica Metric Thread</th></tr> <tr><td>M5</td><td>M5</td></tr> <tr><td>M6</td><td>M6</td></tr> <tr><td>M7</td><td>M7</td></tr> <tr><th colspan="2">Cilíndrica BSPP BSPP thread</th></tr> <tr><td>01</td><td>G1/8"</td></tr> <tr><td>02</td><td>G1/4"</td></tr> <tr><td>03</td><td>G3/8"</td></tr> <tr><td>04</td><td>G1/2"</td></tr> </table>	Métrica Metric Thread		M5	M5	M6	M6	M7	M7	Cilíndrica BSPP BSPP thread		01	G1/8"	02	G1/4"	03	G3/8"	04	G1/2"
Código	Tubo																																							
03	3mm																																							
04	4mm																																							
05	5mm																																							
06	6mm																																							
07	7mm																																							
08	8mm																																							
10	10mm																																							
12	12mm																																							
14	14mm																																							
Métrica Metric Thread																																								
M5	M5																																							
M6	M6																																							
M7	M7																																							
Cilíndrica BSPP BSPP thread																																								
01	G1/8"																																							
02	G1/4"																																							
03	G3/8"																																							
04	G1/2"																																							

Tolerancia diámetro exterior del tubo - Outer diameter tube tolerance

Tubo • Tube	Ø3mm	Ø4mm	Ø6mm	Ø8mm	Ø10mm	Ø12mm	Ø14mm
Tolerancia tolerance	±0,07					±0,1	

Datos Técnicos

Aplicaciones	Neumática y fluidos
Materiales utilizados	Cuerpo: latón niquelado UNI EN 12164 CW 614N y UNI EN 12164 CW 617N
	Anillo pulsador: latón niquelado UNI EN 12164 CW 614N y UNI EN 12164 CW 617N
	Pinza de agarre: acero inox AISI 304
	Junta tórica : NBR
Roscas	Rosca Cilíndrica BSPP UNI ISO 228 de 1/8" a 1/2"
	Métrica ISO/R262
Presión de trabajo	La presión varía dependiendo del tubo utilizado. En ningún caso deberá superar 18 bar.
Temperatura de trabajo	de -20°C a 70°C
Tubos utilizados	Poliamida (PA)
	Poliuretano (PU)
	Polietileno (PE)
Producto conforme a la directiva 2002/95/EC RoHS	

Technical Specifications

Applications	Pneumatics & fluids
Materials used	Body: nickel plated brass UNI EN 12164 CW 614N & UNI EN 12164 CW 617N
	Collet: nickel plated brass UNI EN 12164 CW 614N & UNI EN 12164 CW 617N
	Lock claw: stainless steel AISI 304
	O'ring: NBR
Threads	Cylindrical gas ISO 228 from 1/8" to 1/2"
	Metric ISO/R262
Working pressure	Pressure varies depending on the kind of tubing use dan in any case it never has to exceed 18 bar.
Working temperature	From -20°C to 70°C
Tubes used	Polyamide (PA)
	Polyurethane (PU)
	Polyethylene (PE)
Products in conformity with the directive 2002/95/EC RoHS	

Racor directo rosca macho cilíndrica BSPP • Male connector BSPP thread with OR

IMOTC	REFERENCIA	ØD	T	ØP	I	L	H1 (Hex)	H2 (Hex)	Peso Weight(g)
	IMOTC03M3	3	M3x0,5	5,5	3	14,5	-	1,5	1,4
	IMOTC03M5		M5x0,8	8	4	15	-	2	2,3
	IMOTC04M5	4	M5x0,8	8	4	19	-	2,5	4,6
	IMOTC04M6		M6x1	9	4,5	19,5	-	3	4,3
	IMOTC04M7		M7x1	9	5	20	-	3	5
	IMOTC06M5	6	M5x0,8	8	4	22	-	2,5	8,6
	IMOTC06M6		M6x1	9	4,5	22,5	-	3	8,9
	IMOTC06M7		M7x1	9	5	23	-	3	9,5
	IMOTC0401	4	G1/8"	13	5	16,5	9	3	6,1
	IMOTC0402		G1/4"	16	6,5	18,5	9	3	11,8
	IMOTC0601	6	G1/8"	13,5	5	19,5	12	4	9
	IMOTC0602		G1/4"	16	6,5	19,5	12	4	12,7
	IMOTC0801	8	G1/8"	13	5	23,5	12	6	11,4
	IMOTC0802		G1/4"	16	6,5	21,5	13	6	13,5
	IMOTC0803		G3/8"	20	7	21	14	6	20,1
	IMOTC1002	10	G1/4"	16	6,5	27,5	14	8	17,4
IMOTC1003	G3/8"		20	7	25	15	8	22,6	
IMOTC1004	G1/2"		25	8,5	25,5	16	8	34,5	
IMOTC1202	12	G1/4"	16	6,5	28,5	16	8	26,2	
IMOTC1203		G3/8"	20	7	28,5	19	10	28,9	
IMOTC1204		G1/2"	25	8,5	26,4	19	10	36,1	
IMOTC1403	14	G3/8"	20	7	32	22	10	37,5	
IMOTC1404		G1/2"	25	8,5	32	22	12	42,4	

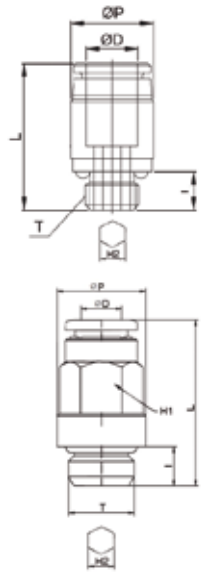

Adaptador con rosca macho cilíndrica BSPP • Stem adapter BSPP thread with OR

IMOTCF	REFERENCIA	ØD	T	ØP	L	H (Hex)	Peso Weight(g)
	IMOTCF0401	4	G1/8"	13	23,5	9	10
	IMOTCF0501	5	G1/8"	12	26	10	11
	IMOTCF0502		G1/4"	17	30	10	21
	IMOTCF0601	6	G1/8"	14	26	12	15,1
	IMOTCF0602		G1/4"	16	30	12	18,5
	IMOTCF0801	8	G1/8"	13	26	14	17,5
	IMOTCF0802		G1/4"	16	30	14	20,2
	IMOTCF1002		10	G1/4"	16	32	16
	IMOTCF1003	G3/8"		20	33,5	16	30,3

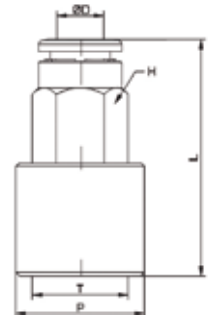

Codo orientable rosca macho cilíndrica BSPP • Swivel male elbow BSPP with OR

IMOTL	REFERENCIA	ØD	T	ØP	L1	L2	H (Hex)	Peso Weight(g)
	IMOTL03M5	3	M5x0,8	7	13,5	14	9	7,1
	IMOTL04M5		M5x0,8	9	17,5	14	9	8,8
	IMOTL04M6		M6x1	9	17,5	14,5	9	8,7
	IMOTL0401	4	G1/8"	9	19,5	18	13	15,7
	IMOTL0402		G1/4"	9	19,5	21,5	13	19
	IMOTL06M5	6	M5x0,8	12	20,5	14	9	11,9
	IMOTL06M6		M6x1	12	20,5	14,5	9	12
	IMOTL0601		G1/8"	12	22	18	13	18,5
	IMOTL0602		G1/4"	12	22	21,5	13	21,8
	IMOTL0801	8	G1/8"	14	22,5	18	13	22
	IMOTL0802		G1/4"	14	22,5	21,5	13	25,3
	IMOTL0803		G3/8"	14	23	25,5	16	37,7
	IMOTL1002	10	G1/4"	16	26	22	16	34
	IMOTL1003		G3/8"	16	26	25,5	16	39,2
	IMOTL1004		G1/2"	16	26	27,5	16	43,2
	IMOTL1202	12	G1/4"	19	28,5	25,5	20	58,5
	IMOTL1203		G3/8"	19	28,5	26	20	56,1
	IMOTL1204		G1/2"	19	28,5	30,5	20	65,1
IMOTL1403	14	G3/8"	22	31	26	20	61,6	
IMOTL1404		G1/2"	22	31	30,5	20	69,9	

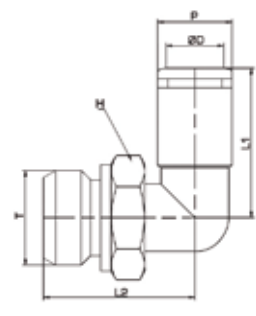

Codo orientable rosca hembra cilíndrica BSPP • Swivel female elbow BSPP

IMOTLF	REFERENCIA	ØD	T	ØP	L1	L2	H (Hex)	Peso Weight(g)
	IMOTLF0401	4	G1/8"	9	19,5	17,5	13	17,3
	IMOTLF0601	6	G1/8"	12	22	17,5	13	19,7
	IMOTLF0602	6	G1/4"	12	22	21,5	16	25,4
	IMOTLF0801	8	G1/8"	14	22,5	17,5	13	23,1
	IMOTLF0802	8	G1/4"	14	22,5	21,5	16	29,1
	IMOTLF1002	10	G1/4"	16	26	23	16	35,6
	IMOTLF1003	10	G3/8"	16	26	25	20	43,5

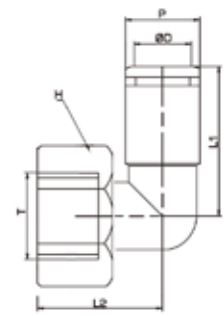

T orientable rosca central macho cilíndrica BSPP • Swivel male tee BSPP thread with OR

IMOTT	REFERENCIA	ØD	T	ØP	L1	L2	H (Hex)	Peso Weight(g)
	IMOTT04M5		M5	9	17,3	20	8	15
	IMOTT0401	4	G1/8"	9	19,5	18	13	20,2
	IMOTT0402	4	G1/4"	9	19,5	21,5	13	23,9
	IMOTT0601	6	G1/8"	12	22	18	13	25,2
	IMOTT0602	6	G1/4"	12	22	21,5	13	29,1
	IMOTT0801	8	G1/8"	14	22,5	18	13	30,7
	IMOTT0802	8	G1/4"	14	22,5	21,5	13	33,6
	IMOTT0803	8	G3/8"	14	23	25,5	13	46,4
	IMOTT1002	10	G1/4"	16	24,5	22	16	44,4
	IMOTT1003	10	G3/8"	16	24,5	25,5	16	49,7
	IMOTT1203	12	G3/8"	19	28,5	26	20	75,3
	IMOTT1204	12	G1/2"	19	28,5	30,5	20	82
	IMOTT1403	14	G3/8"	21	31,5	28	18	89

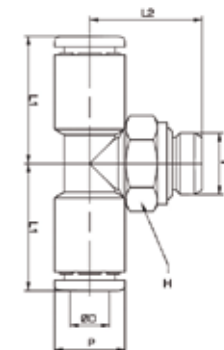

T orientable lateral rosca macho cilíndrica BSPP • Swivel lateral male tee BSPP thread with OR

IMOTST	REFERENCIA	ØD	T	ØP	L1	L2	H (Hex)	Peso Weight(g)
	IMOTST0401	4	G1/8"	9	19,5	18	13	20,5
	IMOTST0402	4	G1/4"	9	19,5	21,5	13	24
	IMOTST0601	6	G1/8"	12	22	18	13	26
	IMOTST0602	6	G1/4"	12	22	21,5	13	29,5
	IMOTST0801	8	G1/8"	14	22,5	18	13	30
	IMOTST0802	8	G1/4"	14	22,5	21,5	13	33,5
	IMOTST1002	10	G1/4"	16	26	22	16	44
	IMOTST1003	10	G3/8"	16	26	25,5	16	49
	IMOTST1203	12	G3/8"	19	28,5	26	20	73
	IMOTST1204	12	G1/2"	19	28,5	30,5	20	77

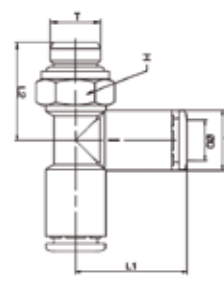

Reducción tubo • Reducer stem-tube

IMOTGJ	REFERENCIA	ESPIGA	RACOR	ØP	L	Peso Weight(g)
	IMOTGJ0403	4	3	7	27	2,5
	IMOTGJ0504	5	4	9	32,5	7
	IMOTGJ0604	6	4	9	33,5	7
	IMOTGJ0804	8	4	9	33,5	10
	IMOTGJ1004	10	4	10	31,5	15
	IMOTGJ1204	12	4	12	32,5	24,5
	IMOTGJ0605	6	5	10	36,5	8,8
	IMOTGJ0805	8	5	10	34	11
	IMOTGJ0406	4	6	12	35,5	10
	IMOTGJ0806	8	6	12	35	11,5
	IMOTGJ1006	10	6	12	36,5	15,5
	IMOTGJ1206	12	6	12	35,5	22,2
	IMOTGJ1406	14	6	14	37,5	25
	IMOTGJ0608	6	8	14	39,5	13,5
	IMOTGJ1008	10	8	14	37	15
	IMOTGJ1208	12	8	14	39	23
	IMOTGJ1408	14	8	14	38,5	31,5
	IMOTGJ1210	12	10	16	42	20
	IMOTGJ1410	14	10	16	42	29,5
	IMOTGJ1412	14	12	19	43	24

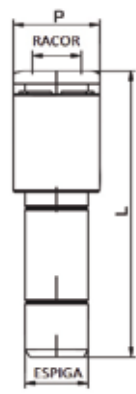

B RACORES AUTOMÁTICOS Push-in fittings

Unión recta tubo tubo • Union connector

IMOTUC	REFERENCIA	ØD	ØP	L	Peso Weight(g)
	IMOTUC03	3	7	22	2,7
	IMOTUC04	4	9	28	6,8
	IMOTUC06	6	12	33,5	15
	IMOTUC08	8	14	34	18
	IMOTUC10	10	16	38,5	22,5
	IMOTUC12	12	19	41	36,6
	IMOTUC14	14	22	47	47,4



Reducción directa tubo tubo • Reduced union connector

IMOTG	REFERENCIA	ØD1	ØD2	ØP	L	Peso Weight(g)
	IMOTG0604	6	4	12	31	14,7
	IMOTG0806	8	6	14	34	21
	IMOTG1008	10	8	16	36,5	25,2



Pasatabiques tubo tubo • Bulkhead connector

IMOTMM	REFERENCIA	ØD	T	L	l max	Peso Weight(g)
	IMOTMM03	3	M10x1	21,5	8	14,5
	IMOTMM04	4	M12x1	28	8	23,5
	IMOTMM05	5	M11x1	33	11	20
	IMOTMM06	6	M14x1	34	16	33
	IMOTMM08	8	M16x1	34	17	39,5
	IMOTMM10	10	M18x1	39	19	51,5
	IMOTMM12	12	M20x1	41	20	60
	IMOTMM14	14	M24x1	47,5	18	99

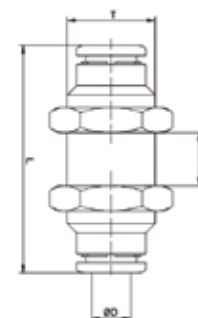

Codo tubo • Union elbow

IMOTUL	REFERENCIA	ØD	ØP	L	Peso Weight(g)
	IMOTUL03	3	7	12	4,5
	IMOTUL04	4	9	17,5	9
	IMOTUL05	5	10	19	11
	IMOTUL06	6	12	20,5	16,5
	IMOTUL08	8	14	22,5	22
	IMOTUL10	10	16	25	29,5
	IMOTUL12	12	19	26,5	48,5
	IMOTUL14	14	22	31,5	58

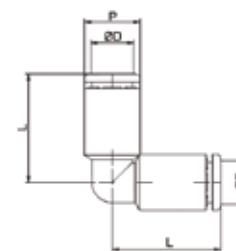

"T" Tubo • Union tee

IMOTUT	REFERENCIA	ØD	ØP	L	Peso Weight(g)
	IMOTUT03	3	7	12	5,6
	IMOTUT04	4	9	17,5	12,5
	IMOTUT06	6	12	20	22,5
	IMOTUT08	8	14	21	28,4
	IMOTUT10	10	16	24,5	39,2
	IMOTUT12	12	19	26	61,3
	IMOTUT14	14	22	30,5	77,1

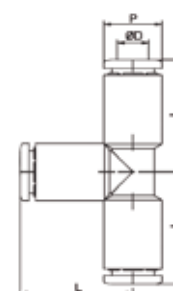

“Y” Unión tubo tubo • Union Y

IMOTY	REFERENCIA	ØD1	ØD2	ØP1	L1	Peso Weight(g)
	IMOTY04	4	4	9	29,5	13,5
	IMOTY06	6	6	12	36	32
	IMOTY08	8	8	14	37,5	42,5
	IMOTY10	10	10	16	44,5	62,7
	IMOTY12	12	12	19	49	95,8

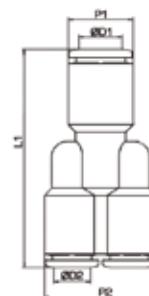

Adaptador con rosca macho cilíndrica BSPP • Adaptor male BSPP thread

IMOTA	REFERENCIA	ØD	T	I	L	H (Hex)	Peso Weight(g)
	IMOTA04M5		M5	4	24	9	3,2
	IMOTA0401	4	G1/8"	5	26	13	7,2
	IMOTA0402		G1/4"	6,5	28,5	16	12,4
	IMOTA05M5		M5	4	25,5	8	4
	IMOTA0501	5	G1/8"	6	29	13	8
	IMOTA0502		G1/4"	8	31,5	13	11
	IMOTA06M5		M5	4	26	9	5,9
	IMOTA0601	6	G1/8"	5	28	13	8,5
	IMOTA0602		G1/4"	6,5	30,5	16	13,7
	IMOTA0801		G1/8"	5	29	13	9,4
	IMOTA0802	8	G1/4"	6,5	31,5	16	14,5
	IMOTA0803		G3/8"	7,5	37	13	20
	IMOTA1001		G1/8"	5,5	35,5	13	16
	IMOTA1002	10	G1/4"	6,5	31,5	16	15,5
	IMOTA1003		G3/8"	7	32,5	20	22
	IMOTA1202		G1/4"	6,5	39	13	22
	IMOTA1203	12	G3/8"	7	33	20	23,6
	IMOTA1204		G1/2"	8,5	35	26	38
	IMOTA1403	14	G3/8"	7,5	44,5	16	23
	IMOTA1404		G1/2"	9	46,5	16	33

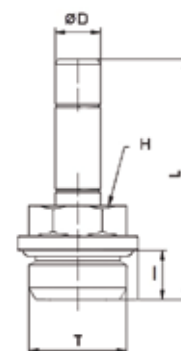



Unión entre racores automáticos • Brass junction

IMOTIJ	REFERENCIA	ØD	ØC	L	Peso Weight(g)
	IMOTIJ04	4	2	35	2,8
	IMOTIJ05	5	3	35	4
	IMOTIJ06	6	4	40	5,5
	IMOTIJ08	8	6	42	7,5
	IMOTIJ10	10	8	50	11
	IMOTIJ12	12	10	53	14
	IMOTIJ14	14	12	54	18,5



Tapón para racor automático • Male plug

IMOTP	REFERENCIA	ØD	L	Peso Weight(g)
	IMOTP03	3	20	1
	IMOTP04	4	25	2,5
	IMOTP05	5	27	3,3
	IMOTP06	6	30	5,5
	IMOTP08	8	30	12,5
	IMOTP10	10	35	23
	IMOTP12	12	38	37,5
	IMOTP14	14	40	32,5



Cruz giratoria intermedia • Intermediate rotating cross

IMOTZA	REFERENCIA	ØD1	ØD2	ØP1	ØP2	L1	L2	Peso Weight(g)
NUEVO 	IMOTZA04	4	4	9	9	18	39	31
	IMOTZA0406	4	6	9	12	18	39	36
	IMOTZA06	6	6	12	12	18	44	41
	IMOTZA0608	6	8	12	14	18	44	46,5
	IMOTZA0808	8	8	14	14	18	45	50

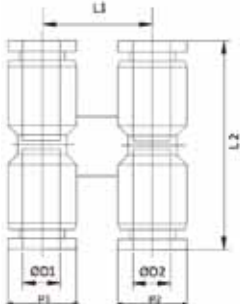

Designación Referencia - Model designation

SXC 04 01
 SXC 04 M5
 SXC 04 G01

↓ ↓ ↓
 Código Diámetro Tubo Rosca
 Code Tube diameter Thread size

Código	Tubo	Cónica BSPT BSPT thread
04	4mm	01 R1/8"
06	6mm	02 R1/4"
08	8mm	03 R3/8"
10	10mm	04 R1/2"
12	12mm	
14	14mm	

Métrica Metric Thread	
M5	M5

Cilíndrica BSPP BSPP thread	
G01	G1/8"
G02	G1/4"
G03	G3/8"
G04	G1/2"

Tolerancia diámetro exterior del tubo - BSPP & Metric Thread

Tubo • tube	Ø4mm	Ø6mm	Ø8mm	Ø10mm	Ø12mm	Ø14mm
Tolerancia tolerance						
PTFE	±0,1			±0,15		
PE-FEP	±0,1					

Componentes - Construction

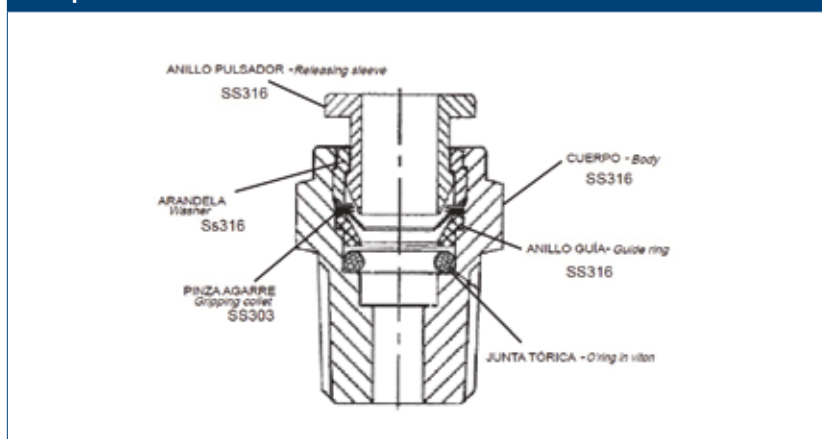

Datos Técnicos

Aplicaciones	Neumática, agua potable y fluidos en sector alimentario, químico, medicinal, farmacéutico y naval.
Materiales utilizados	Cuerpo: acero Inox AISI 316
	Anillo pulsador: acero Inox AISI 316
	Pinza de agarre: inox AISI 303
	Junta tórica : Vitón
Roscas	Gas cónica ISO 7 BSPT de 1/8" a 1/2"
	Gas cilíndrica ISO 228 BSPP de 1/8" a 1/2"
	Métrica M5
Tratamiento de la superficie	Todos y cada uno de los componentes de este racor han sido tratados para garantizar la resistencia superficial a la corrosión.
Presión de trabajo	20 Bar a 20°C
Temperatura de trabajo	De -20°C a +150°C
Tubos utilizados	Polietileno (PE)
	PTFE Calibrado
	Fluoropolimero FEP 140
Características	Tubo de acero INOX (Consultar Dpto. Técnico)
	Los racores de esta serie son idóneos para el contacto con fluidos agresivos

Producto conforme a la directiva 2002/95/EC **RoHS**

Technical Specifications

Applications	Pneumatics, drinking water, fluids, food, chemical, medical, pharmaceutical & marine applications
Materials used	Body: stainless steel AISI 316
	Collet: stainless steel AISI 316
	Lock claw: stainless steel AISI 303
	O'ring: Viton
Threads	Taper Gas Thread ISO 7 from 1/8" to 1/2"
	Cylindrical Gas ISO 228 from 1/8" to 1/2"
	Metric M5
Surface treatment	Each and every steel components of push-in fittings are electropolished to ensure a corrosion resistant surface layer of chromide oxide which is passive
Working pressure	20 Bar at 20°C
Working temperature	from -20°C to +150°C
Tubes used	Polyethylene (PE)
	Calibrated Teflon PTFE
	Fluoropolymer FEP 140
Advantages	Stainless steel tube when grooved with pre-grooving
	The fittings of this range are also suitable for the contact with aggressive fluids

Products in conformity with the directive 2002/95/EC **RoHS**



INSTRUCCIONES PARA EL CORRECTO USO DEL RACOR

- Conectar la tubería una vez eliminada la suciedad e impurezas.
- Para aplicaciones con productos químicos consultar con el Departamento Técnico de IMOPAC.
- Se recomienda antes de realizar cualquier conexión, cortar el tubo correctamente a 90° y evitar cualquier ralladura sobre la superficie del tubo para prevenir fugas.
- No aplicar grandes vibraciones, rotaciones, aplastamientos ni cargas sobre el racor.
- Verificar que el apriete de la rosca se ha efectuado correctamente, un exceso de apriete podría ocasionar daños y roturas del racor.
- Antes de desconectar la tubería del racor compruebe siempre que el sistema está sin presión, de otra manera podría ocasionar lesiones o accidentes.
- Realizar verificaciones y pruebas si fuera necesario para obtener un funcionamiento correcto, también sugerimos un mantenimiento habitual del sistema.
- Seleccionar la tubería adecuada.

WARNING

- Assemble the pipes only after clearing away impurities such as dust.
- Where fittings may be used with chemical please contact IMOPAC Technical Service for advise.
- Be sure to prevent pressure buildup caused by twisting, pulling and bending of the fitting.
- We recommend, before making any connection, to cut the tube square and to avoid any scratches on the tube surface to prevent any leakages.
- Do not apply serious vibration, rotation, body pulling, twisting, bending and other load to the fittings as the body may be damaged or the collet dislocated.
- Please tighten the screws at a proper torque, if the screws are tightened at excess torque, the screw head may be damaged and broken.
- Before disassembling the fittings from the tube please always check & verify that pressure has been removed from the system, otherwise any accident may occur.
- Perform any checks and testing necessary to verify acceptable function, we suggest you also a good care and a check of the system quite often.
- Use the tube according to the application.

Directo rosca macho cónica BSPT • Male connector BSPT thread

IMOSXC	REFERENCIA	ØD	T	ØP	L1	L2	H (Hex)	Peso Weight(g)
	IMOSXC0401	4	R1/8"	9,8	18,6	8,5	11,1	10,0
	IMOSXC0402		R1/4"		23,0	12,5	14,2	19,0
	IMOSXC0601	6	R1/8"	12,5	23,7	8,5	12,7	13,0
	IMOSXC0602		R1/4"		23,7	12,5	14,2	17,0
	IMOSXC0801	8	R1/8"	14,2	26,7	8,5	14,2	16,0
	IMOSXC0802		R1/4"		27,7	12,5	14,2	19,0
	IMOSXC0803		R3/8"		27,1	12,5	17,4	33,0
	IMOSXC1002	10	R1/4"	16,4	29,0	12,5	17,4	26,0
	IMOSXC1003		R3/8"		27,7	12,5	17,4	28,0
	IMOSXC1202	12	R1/4"	19,0	32,4	12,5	20,6	40,0
	IMOSXC1203		R3/8"		30,9	12,5	20,6	42,0
	IMOSXC1204		R1/2"		32,4	16,5	22,2	58,0
	IMOSXC1404	14	R1/2"	21,8	34,4	16,5	22,2	54,0

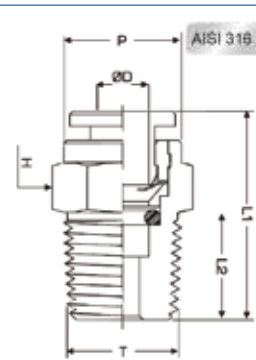

Directo rosca macho cilíndrica BSPP y métrica • Male connector BSPP & metric thread

IMOSXC-G	REFERENCIA	ØD	T	ØP	L1	L2	H (Hex)	Peso Weight(g)
	IMOSXC04M5	4	M5	9,8	24,4	7,5	11,1	10,0
	IMOSXC04-G01		G1/8"		22,6	8,0	14,2	17,0
	IMOSXC04-G02		G1/4"		24,1	10,0	17,4	24,0
	IMOSXC06M5	6	M5	12,5	24,8	5,5	12,7	10,0
	IMOSXC06-G01		G1/8"		24,6	8,0	14,2	16,0
	IMOSXC06-G02		G1/4"		24,6	10,0	17,4	23,0
	IMOSXC08-G01	8	G1/8"	14,2	27,6	8,0	14,2	17,0
	IMOSXC08-G02		G1/4"		26,6	10,0	17,4	24,0
	IMOSXC08-G03		G3/8"		26,7	10,0	20,6	37,0
	IMOSXC10-G02	10	G1/4"	16,4	29,6	10,0	17,4	28,0
	IMOSXC10-G03		G3/8"		26,8	10,0	20,6	35,0
	IMOSXC12-G02	12	G1/4"	19,0	31,0	10,0	20,6	35,0
	IMOSXC12-G03		G3/8"		31,0	10,0	20,6	40,0
	IMOSXC12-G04		G1/2"		30,5	12,0	27,0	64,0
	IMOSXC14-G04	14	G1/2"	21,8	31,5	12,0	27,0	103,0

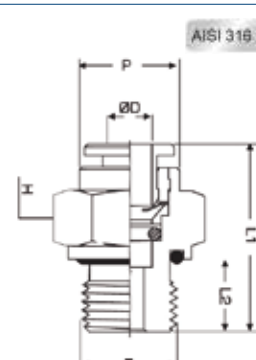

Codo orientable rosca macho cónica BSPT • Swivel male elbow BSPT thread

IMOSXL	REFERENCIA	ØD	T	ØP	L1	L2	L3	H1 (Hex)	H2 (Hex)	Peso Weight(g)
	IMOSXL0401	4	R1/8"	9,8	17,1	26,7	8,5	11,1	11,1	27,0
	IMOSXL0402		R1/4"		17,1	29,8	12,5	11,1	14,2	38,0
	IMOSXL0601	6	R1/8"	12,5	20,6	27,7	8,5	12,7	12,7	36,0
	IMOSXL0602		R1/4"		20,6	30,7	12,5	12,7	14,2	42,0
	IMOSXL0801	8	R1/8"	14,2	21,4	28,7	8,5	14,2	14,2	44,0
	IMOSXL0802		R1/4"		21,4	32,7	12,5	14,2	14,2	48,0
	IMOSXL0803		R3/8"		21,4	32,7	12,5	14,2	17,4	61,0
	IMOSXL1002	10	R1/4"	16,4	24,6	33,9	12,5	17,4	17,4	72,0
	IMOSXL1003		R3/8"		24,6	34,1	12,5	17,4	17,4	78,0
	IMOSXL1202	12	R1/4"	19,0	25,6	37,3	12,5	20,6	20,6	105,0
	IMOSXL1203		R3/8"		25,6	37,3	12,5	20,6	20,6	106,0
	IMOSXL1204		R1/2"		25,6	39,8	16,5	20,6	22,2	124,0
	IMOSXL1404	14	R1/2"	21,8	27,5	42,6	16,5	22,2	22,2	151,0

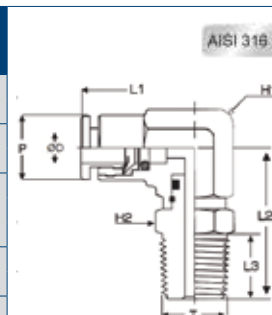

Codo orientable rosca macho cilíndrica BSPP y métrica • Swivel male elbow BSPP & metric thread

IMOSXL-G	REFERENCIA	ØD	T	ØP	L1	L2	L3	H1 (Hex)	H2 (Hex)	Peso Weight(g)
	IMOSXL04M5	4	M5	9,8	17,1	26,5	7,5	11,1	11,1	27,0
	IMOSXL04-G01		G1/8"		17,1	26,9	8,0	11,1	14,2	31,0
	IMOSXL04-G02		G1/4"		17,1	28,9	10,0	11,1	17,4	41,0
	IMOSXL06M5	6	M5	12,5	20,6	25,8	5,5	12,7	12,7	27,0
	IMOSXL06-G01		G1/8"		20,6	27,8	8,0	12,7	14,2	35,0
	IMOSXL06-G02		G1/4"		20,6	30,0	10,0	12,7	17,4	45,0
	IMOSXL08-G01	8	G1/8"	14,2	21,4	29,8	8,0	14,2	14,2	45,0
	IMOSXL08-G02		G1/4"		21,4	32,0	10,0	14,2	17,4	53,0
	IMOSXL08-G03		G3/8"		21,4	32,0	10,0	14,2	20,6	63,0
	IMOSXL10-G02	10	G1/4"	16,4	24,6	33,1	10,0	17,4	17,4	75,0
	IMOSXL10-G03		G3/8"		24,6	33,1	10,0	17,4	20,6	80,0
	IMOSXL12-G02	12	G1/4"	19,0	25,6	35,3	10,0	20,6	19,0	103,0
	IMOSXL12-G03		G3/8"		25,6	35,8	10,0	20,6	20,6	103,0
	IMOSXL12-G04		G1/2"		25,6	38,8	12,0	20,6	27,0	132,0
	IMOSXL14-G04	14	G1/2"	21,8	27,5	40,8	12,0	22,2	27,0	162,0

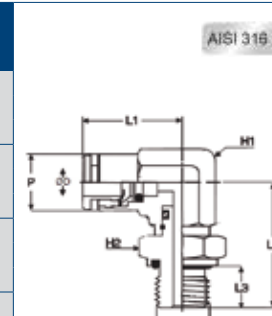

Codo fijo rosca macho cónica BSPT • Fixed male elbow BSPT thread

IMOSXME	REFERENCIA	ØD	T	ØP	L1	L2	L3	H(Hex)	Peso Weight(g)
	IMOSXME0401	4	R1/8"	9,8	16,4	17,3	8,5	11,1	20,0
	IMOSXME0402		R1/4"		18,0	23,5	12,5	14,2	45,0
	IMOSXME0601	6	R1/8"	12,5	20,6	18,0	8,5	12,7	30,0
	IMOSXME0602		R1/4"		21,4	23,5	12,5	14,2	42,0
	IMOSXME0801	8	R1/8"		21,4	19,5	8,5	14,2	33,0
	IMOSXME0802		R1/4"	14,2	21,4	23,5	12,5	14,2	39,0
	IMOSXME0803		R3/8"		24,6	25,2	12,5	17,4	64,0
	IMOSXME1002	10	R1/4"		24,6	25,2	12,5	17,4	88,0
	IMOSXME1003		R3/8"	16,4	24,6	25,2	12,5	17,4	64,0
	IMOSXME1202	12	R1/4"		25,6	26,9	12,5	20,6	82,0
	IMOSXME1203		R3/8"	19,0	25,6	26,9	12,5	20,6	88,0
	IMOSXME1204		R1/2"		25,6	30,9	16,5	20,6	127,0



"T" Orientable rosca macho cónica central BSPT • Swivel male tee BSPT thread

IMOSXT	REFERENCIA	ØD	T	ØP	L1	L2	L3	H1 (Hex)	H2 (Hex)	Peso Weight(g)
	IMOSXT0401	4	R1/8"	9,8	34,2	26,7	8,5	11,1	11,1	35,0
	IMOSXT0402		R1/4"		34,2	29,8	12,5	11,1	14,2	48,0
	IMOSXT0601	6	R1/8"	12,5	41,2	27,7	8,5	12,7	12,7	42,0
	IMOSXT0602		R1/4"		41,2	30,7	12,5	12,7	14,2	48,0
	IMOSXT0801	8	R1/8"		42,8	28,7	8,5	14,2	14,2	53,0
	IMOSXT0802		R1/4"	14,2	42,8	32,7	12,5	14,2	14,2	59,0
	IMOSXT0803		R3/8"		42,8	32,7	12,5	14,2	17,4	70,0
	IMOSXT1002	10	R1/4"		49,2	33,9	12,5	17,4	17,4	86,0
	IMOSXT1003		R3/8"	16,4	49,2	34,1	12,5	17,4	17,4	93,0
	IMOSXT1202	12	R1/4"		51,2	37,3	12,5	20,6	20,6	123,0
	IMOSXT1203		R3/8"	19,0	51,2	37,3	12,5	20,6	20,6	128,0
	IMOSXT1204		R1/2"		51,2	39,8	16,5	20,6	22,2	145,0

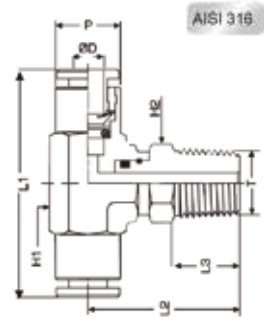

"T" Orientable rosca macho cilíndrica BSPP y métrica • Swivel male tee BSPP & metric thread

IMOSXT-G	REFERENCIA	ØD	T	ØP	L1	L2	L3	H1 (Hex)	H2 (Hex)	Peso Weight(g)
	IMOSXT04M5	4	M5	9,8	34,2	26,5	7,5	11,1	11,1	31,0
	IMOSXT04-G01		G1/8"		34,2	26,9	8,0	11,1	14,2	36,0
	IMOSXT04-G02		G1/4"		34,2	28,9	10,0	11,1	17,4	44,0
	IMOSXT06-G01	6	G1/8"	12,5	41,2	27,8	8,0	12,7	14,2	45,0
	IMOSXT06-G02		G1/4"		41,2	30,0	10,0	12,7	17,4	53,0
	IMOSXT08-G01	8	G1/8"		42,8	29,8	8,0	14,2	14,2	53,0
	IMOSXT08-G02		G1/4"	14,2	42,8	32,0	10,0	14,2	17,4	60,0
	IMOSXT08-G03		G3/8"		42,8	32,0	10,0	14,2	20,6	72,0
	IMOSXT10-G02	10	G1/4"		49,2	33,1	10,0	17,4	17,4	84,0
	IMOSXT10-G03		G3/8"	16,4	49,2	33,1	10,0	17,4	20,6	91,0
	IMOSXT12-G02	12	G1/4"		51,2	35,3	10,0	20,6	19,0	122,0
	IMOSXT12-G03		G3/8"	19,0	51,2	35,8	10,0	20,6	20,6	129,0
IMOSXT12-G04		G1/2"		51,2	38,8	12,0	20,6	27,0	149,0	

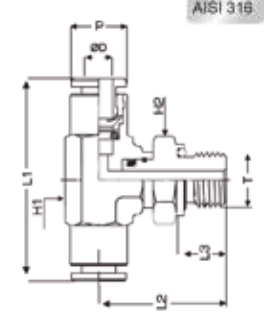

"T" Orientable lateral rosca macho cónica BSPT • Swivel lateral male tee BSPT thread

IMOSXST	REFERENCIA	ØD	T	ØP	L1	L2	L3	H1 (Hex)	H2 (Hex)	Peso Weight(g)
	IMOSXST0401	4	R1/8"	9,8	17,1	26,7	8,5	11,1	11,1	35,0
	IMOSXST0402		R1/4"		17,1	29,8	12,5	11,1	14,2	48,0
	IMOSXST0601	6	R1/8"	12,5	20,6	27,7	8,5	12,7	12,7	42,0
	IMOSXST0602		R1/4"		20,6	30,7	12,5	12,7	14,2	48,0
	IMOSXST0801	8	R1/8"		21,4	28,7	8,5	14,2	14,2	53,0
	IMOSXST0802		R1/4"	14,2	21,4	32,7	12,5	14,2	14,2	59,0
	IMOSXST0803		R3/8"		21,4	32,7	12,5	14,2	17,4	70,0
	IMOSXST1002	10	R1/4"		24,6	33,9	12,5	17,4	17,4	86,0
	IMOSXST1003		R3/8"	16,4	24,6	34,1	12,5	17,4	17,4	93,0
	IMOSXST1202	12	R1/4"		25,6	37,3	12,5	20,6	20,6	123,0
	IMOSXST1203		R3/8"	19,0	25,6	37,3	12,5	20,6	20,6	128,0
	IMOSXST1204		R1/2"		25,6	39,8	16,5	20,6	22,2	145,0

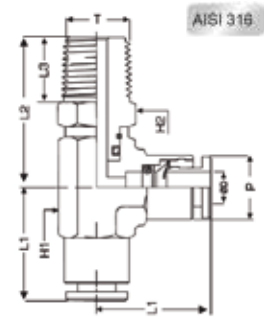

Pasatabique tubo-tubo • Bulkhead connector

IMOSXMM	REFERENCIA	ØD	T	ØP	L1	A max	H (Hex)	Peso Weight(g)
	IMOSXMM04	4	M11x0,75	9,8	32,7	6,0	14,2	24,0
	IMOSXMM06	6	M13x1	12,5	35,7	6,0	19,0	38,0
	IMOSXMM08	8	M16x1,25	14,2	36,7	6,0	20,6	45,0
	IMOSXMM10	10	M18x1	16,4	43,2	8,0	22,2	64,0
	IMOSXMM12	12	M22x1,5	19,0	46,8	10,0	27,0	100,0

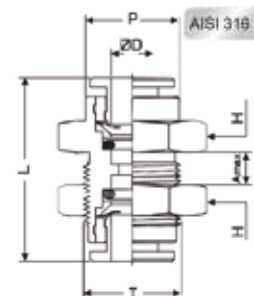

Unión recta tubo-tubo • Union connector

IMOSXUC	REFERENCIA	ØD	ØP	L	Peso Weight(g)
	IMOSXUC04	4	9,8	29,2	14,0
	IMOSXUC06	6	12,5	34,6	20,0
	IMOSXUC08	8	14,2	34,6	21,0
	IMOSXUC10	10	16,4	35,7	30,0
	IMOSXUC12	12	19,0	37,8	40,0
	IMOSXUC14	14	21,8	40,8	53,0

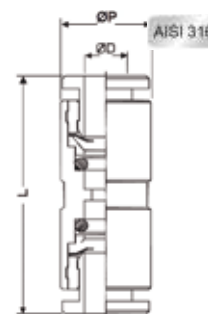

Codo tubo-tubo • Union elbow

IMOSXUL	REFERENCIA	ØD	ØP	L	H (Hex)	Peso Weight(g)
	IMOSXUL04	4	9,8	16,4	11,1	21,0
	IMOSXUL06	6	12,5	20,6	12,7	27,0
	IMOSXUL08	8	14,2	21,4	14,2	35,0
	IMOSXUL10	10	16,4	24,6	17,4	58,0
	IMOSXUL12	12	19,0	25,6	20,6	83,0
	IMOSXUL14	14	21,8	27,5	22,2	107,0

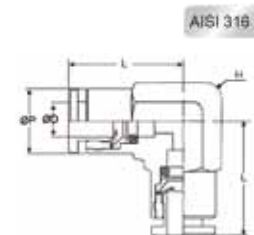

"T" Tubo • Union tee

IMOSXUT	REFERENCIA	ØD	ØP	L1	L2	H (Hex)	Peso Weight(g)
	IMOSXUT04	4	9,8	32,8	16,4	11,1	27,0
	IMOSXUT06	6	12,5	41,2	20,6	12,7	37,0
	IMOSXUT08	8	14,2	42,8	21,4	14,2	43,0
	IMOSXUT10	10	16,4	49,2	24,6	17,4	68,0
	IMOSXUT12	12	19,0	51,2	25,6	20,6	99,0
	IMOSXUT14	14	21,8	55,0	27,5	22,2	129,0



Reducción • Reducer

IMOSXGJ	REFERENCIA	ØD1	ØD2	P	L	Peso Weight(g)
	IMOSXGJ0604	6	4	9,8	35,6	11,0
	IMOSXGJ0804	8	4	9,8	35,6	14,0
	IMOSXGJ0806	8	6	12,5	42,1	17,0
	IMOSXGJ1006	10	6	12,5	43,1	23,0
	IMOSXGJ1008	10	8	14,2	43,1	23,0
	IMOSXGJ1208	12	8	14,2	46,1	31,0
	IMOSXGJ1210	12	10	16,4	46,6	31,0
	IMOSXGJ1412	14	12	19,0	50,0	40,0

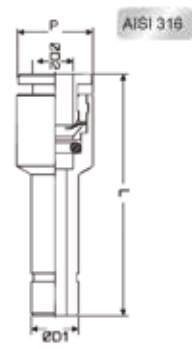

Adaptador rosca macho cilíndrica BSPP • Adapter BSPP thread

IMOSXTA	REFERENCIA	ØD	T	L	H (Hex)	Peso Weight(g)
	IMOSXTA04M5	4	M5	35,7	11,1	8,0
	IMOSXTA0401	4	G1/8"	36,2	14,2	15,0
	IMOSXTA0402	4	G1/4"	38,2	17,4	25,0
	IMOSXTA0601	6	G1/8"	41,2	14,2	16,0
	IMOSXTA0602	6	G1/4"	43,2	17,4	27,0
	IMOSXTA0603	6	G3/8"	43,2	20,6	30,0
	IMOSXTA0801	8	G1/8"	41,2	14,2	18,0
	IMOSXTA0802	8	G1/4"	43,2	17,4	28,0
	IMOSXTA1002	10	G1/4"	46,8	17,4	30,0
	IMOSXTA1003	10	G3/8"	46,8	20,6	44,0
	IMOSXTA1202	12	G1/4"	48,8	20,6	37,0
	IMOSXTA1203	12	G3/8"	48,8	20,6	45,0

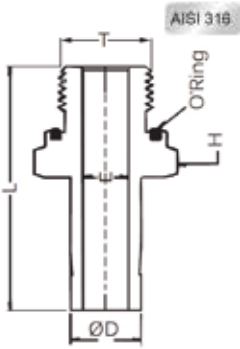

NUEVO

MÉTRICA - METRIC

Designación de la referencia - Model designation

Rosca cónica BSPT - BSPT thread

HPC	06	R01																						
Código Code	Diámetro Tubo Tube diameter	Rosca Thread size																						
	<table border="1"> <tr><th>Código</th><th>Tubo</th></tr> <tr><td>04</td><td>4mm</td></tr> <tr><td>06</td><td>6mm</td></tr> <tr><td>08</td><td>8mm</td></tr> <tr><td>10</td><td>10mm</td></tr> <tr><td>12</td><td>12mm</td></tr> </table>	Código	Tubo	04	4mm	06	6mm	08	8mm	10	10mm	12	12mm	<table border="1"> <tr><th colspan="2">Cónica BSPT BSPT thread</th></tr> <tr><td>R01</td><td>R1/8"</td></tr> <tr><td>R02</td><td>R1/4"</td></tr> <tr><td>R03</td><td>R3/8"</td></tr> <tr><td>R04</td><td>R1/2"</td></tr> </table>	Cónica BSPT BSPT thread		R01	R1/8"	R02	R1/4"	R03	R3/8"	R04	R1/2"
Código	Tubo																							
04	4mm																							
06	6mm																							
08	8mm																							
10	10mm																							
12	12mm																							
Cónica BSPT BSPT thread																								
R01	R1/8"																							
R02	R1/4"																							
R03	R3/8"																							
R04	R1/2"																							

Rosca cilíndrica BSPP - BSPP thread

HPC	06	G01																						
Código Code	Diámetro Tubo Tube diameter	Rosca Thread size																						
	<table border="1"> <tr><th>Código</th><th>Tubo</th></tr> <tr><td>04</td><td>4mm</td></tr> <tr><td>06</td><td>6mm</td></tr> <tr><td>08</td><td>8mm</td></tr> <tr><td>10</td><td>10mm</td></tr> <tr><td>12</td><td>12mm</td></tr> </table>	Código	Tubo	04	4mm	06	6mm	08	8mm	10	10mm	12	12mm	<table border="1"> <tr><th colspan="2">Cilíndrica BSPP BSPP thread</th></tr> <tr><td>G01</td><td>R1/8"</td></tr> <tr><td>G02</td><td>R1/4"</td></tr> <tr><td>G03</td><td>R3/8"</td></tr> <tr><td>G04</td><td>R1/2"</td></tr> </table>	Cilíndrica BSPP BSPP thread		G01	R1/8"	G02	R1/4"	G03	R3/8"	G04	R1/2"
Código	Tubo																							
04	4mm																							
06	6mm																							
08	8mm																							
10	10mm																							
12	12mm																							
Cilíndrica BSPP BSPP thread																								
G01	R1/8"																							
G02	R1/4"																							
G03	R3/8"																							
G04	R1/2"																							

Datos Técnicos

Fluidos compatibles	Agua, bebidas, aire comprimido, vacío, gases y líquidos adecuados con materiales de construcción seleccionados				
Materiales utilizados	Cuerpo: POM				
	Pinza: POM + SUS 301				
	Juntas: EPDM idóneo para el contacto con alimento				
Roscas	Gas cónica BSPT ISO 7 de R1/8" a R1/2"				
	Gas cilíndrica BSPP ISO 228 de G1/8" a G1/2"				
Par máximo	1/8" y 1/4": 1,5 N/m				
	3/8" y 1/2": 3 N/m				
Presión de trabajo	de -750mmHg a 20 bar				
Temperatura de trabajo	Hasta 98°C				
°C/MM	4	6	8	10	12
1°C *	20bar	20bar	20bar	16bar	14bar
25°C *	20bar	20bar	20bar	16bar	14bar
70°C *	16bar	16bar	16bar	14bar	12bar
98°C *	10bar	10bar	10bar	8bar	6bar
Tubos utilizados	Plásticos: Poliamida (PA)-Polietileno (PE)-PUES-PUET-PTFE-FEP (tolerancia ±0,1mm)				
	Metálicos: Latón, cobre. Consultar a nuestro departamento técnico para tubos en acero inoxidable y otros materiales.				
Producto conforme a la directiva 2002/95/EC					
Producto conforme a la directiva 1907/2006					

Technical specifications

Fluids	Fluid types water, beverages, compressed air, vacuum, selected gases & liquids suitable with construction materials					
Materials used	Body: POM					
	Collet: POM + SUS 301					
	Seals: EPDM suitable for food contact					
Threads	Gas BSPT ISO 7 from R1/8" to R1/2"					
	Gas BSPP ISO 228 from G1/8" to G1/2"					
Max torque	1/8" & 1/4": 1,5 N/m					
	3/8" & 1/2": 3 N/m					
Working pressure	From -750mmHg to 20 bar					
Working temperature	up to 98°C					
	°C/MM	4	6	8	10	12
	1°C *	20bar	20bar	20bar	16bar	14bar
	25°C *	20bar	20bar	20bar	16bar	14bar
	70°C *	16bar	16bar	16bar	14bar	12bar
	98°C *	10bar	10bar	10bar	8bar	6bar
Tubes used	Plastics: Polyamide (PA)-Polyethylene (PE)-PUES-PUET-PTFE-FEP (tolerance ±0,1mm)					
	Metals: Brass,copper. Please contact our technical department for stainless steel and other materials.					
Products in conformity with the directive 2002/95/EC						
Products in conformity with the directive 1907/2006						

Conexión rosca cónica macho BSPT • Male plug BSPT threads

HPC	REFERENCIA	ØD	T	A	B	ØE	L	H (Hex)	Peso Weight(g)
	HPC06R01W	6	R1/8"	9,1	16,1	18,5	26,2	17	4,0
	HPC06R02W		R1/4"	13,1	16,1	18,5	26,7	17	4,2
	HPC08R01W	8	R1/8"	9,1	17,5	21,0	28,1	19	5,3
	HPC08R02W		R1/4"	13,1	17,5	21,0	30,6	19	5,8
	HPC10R03W	10	R3/8"	13,5	20,1	23,2	28,8	21	6,7
	HPC10R04W		R1/2"	16,3	20,1	24,4	32,1	22	9,5
	HPC12R03W	12	R3/8"	13,5	24,7	26,5	32,2	24	8,8
	HPC12R04W		R1/2"	16,3	24,7	26,5	34,3	24	11,1

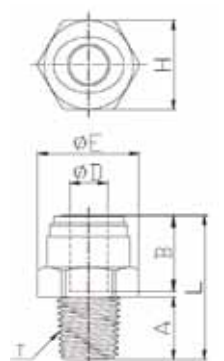

Conexión rosca cilíndrica macho BSPP con junta • Male plug BSPP thread with OR

HPC-G	REFERENCIA	ØD	T	A	B	ØE	L	H (Hex)	Peso Weight(g)
	HPC04G01W	4	G1/8"	6,0	14,7	16,6	21,9	15	3,3
	HPC04G02W		G1/4"	8,5	14,7	20,5	23,9	18	4,8
	HPC06G01W	6	G1/8"	6,0	16,1	16,6	24,1	15	3,3
	HPC06G02W		G1/4"	8,5	16,1	20,5	24,1	18	4,8
	HPC08G01W	8	G1/8"	6,0	17,5	18,5	27,0	17	5,2
	HPC08G02W		G1/4"	8,5	17,5	20,5	28,5	18	6,1
	HPC08G03W		G3/8"	9,0	17,5	24,0	26,5	21	7,0
	HPC08G04W		G1/2"	12,5	17,5	28,5	29,5	26	11,9
	HPC10G02W	10	G1/4"	8,5	17,5	24,1	30,8	19	7,2
	HPC10G03W		G3/8"	9,0	20,1	24,2	26,3	21	7,0
	HPC10G04W		G1/2"	12,5	20,1	28,5	29,8	26	7,9
	HPC12G03W		12	G3/8"	9,0	24,7	27,0	34,2	24
HPC12G04W	G1/2"	12,5		24,7	28,5	32,7	26	12,5	

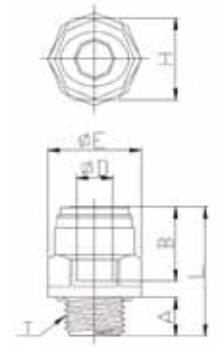

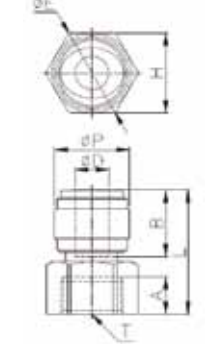

Conexión rosca hembra cilíndrica BSPP con junta plana en EPDM • Female connector BSPP thread with EPDM flat seal

HCF	REFERENCIA	ØD	T	ØP	A	B	ØE	L	H (Hex)	Peso Weight(g)
	HCF06G01W	6	G1/8"	17,6	6	16,1	19,2	27,1	17	6
	HCF06G02W		G1/4"	17,6	8,5	16,1	21,5	29,1	19	7
	HCF08G01W	8	G1/8"	17,6	6	17,5	19,2	27,5	17	6
	HCF08G02W		G1/4"	17,6	8,5	17,5	21,5	29,5	19	7
	HCF08G03W		G3/8"	17,6	9	17,5	27,3	31	24	13
	HCF08G04W		G1/2"	20	12,5	17,5	30	38	27	14
	HCF10G03W	10	G3/8"	23	9	20,1	27,3	37	24	14
	HCF10G04W		G1/2"	20	12,5	20,1	30	38,3	27	13
	HCF12G03W	12	G3/8"	23	9	24,7	27,3	37,7	24	13
	HCF12G04W		G1/2"	23	12,5	24,7	30	41,7	27	14



Codo rosca macho cónico BSPT • Male elbow BSPT thread

HPL	REFERENCIA	ØD	T	ØP	A	B	ØE	L	H (Hex)	Peso Weight(g)
	HPL04R01W	4	R1/8"	13,2	9,1	14,7	-	-	-	3
	HPL06R01W	6	R1/8"	15	9,1	16,1	25,6	25,4	10	4
	HPL06R02W		R1/4"	15	13,1	16,1	30,6	27	10	5,1
	HPL08R02W	8	R1/4"	17,6	13,1	17,5	32,2	31,5	13	6,9
	HPL10R03W	10	R3/8"	20	13,5	20,1	35,7	33,9	14	9,2
	HPL12R04W		R3/8"	23	16,3	24,7	41,4	40,7	17	15,6



Pasatabiques • Bulkhead

HMM	REFERENCIA	ØD1	ØD2	T	A	E	B1	B2	H1 (Hex)	H2 (Hex)	L	Peso Weight(g)
	HMM0604W	6	4	M17x1,5	7,9	7	16,1	--	19	21	--	12
	HMM0606W	6	6	M17x1,5	7,9	7	16,1	16,1	19	21	34,2	12
	HMM0806W	8	6	M20x1,75	9,4	8	17,5	16,1	21	25,5	38,1	14
	HMM0808W	8	8	M20x1,75	9,4	8	17,5	17,5	21	25,5	38,5	14
	HMM1010W	10	10	M24x1,75	10,8	8,5	20,1	20,1	24	28,5	42,2	17
HMM1212W	12	12	M27x2	16,4	9	24,7	24,7	27	31	51,4	20	

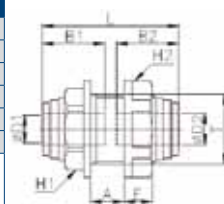

Adaptador con rosca macho cónica BSPT • Stem adapter BSPT thread

HCJ	REFERENCIA	ØD	T	A	B	ØE	L	H (Hex)	Peso Weight(g)
	HCJ04R01W	4	R1/8"	9,1	18,0	14,4	33,1	13	2,6
	HCJ04R02W		R1/4"	13,1	18,0	18,5	37,1	17	4,2
	HCJ06R01W	6	R1/8"	9,1	19,5	14,4	34,6	13	2,8
	HCJ06R02W		R1/4"	13,1	19,5	18,5	38,6	17	4,3
	HCJ08R01W	8	R1/8"	9,1	21,0	14,4	36,1	13	3,0
	HCJ08R02W		R1/4"	13,1	21,0	18,5	40,1	17	4,6
	HCJ08R03W		R3/8"	13,5	21,0	23,0	40,5	21	6,2
	HCJ10R02W	10	R1/4"	13,1	24,0	18,5	43,1	17	5,3
	HCJ10R03W		R3/8"	13,5	24,0	23,0	44,0	21	6,8
	HCJ10R04W		R1/2"	16,3	24,0	26,5	47,0	24	10,6
	HCJ12R03W	12	R3/8"	13,5	28,0	23,0	48,0	21	7,3
	HCJ12R04W		R1/2"	16,5	28,0	26,5	51,0	24	11,0

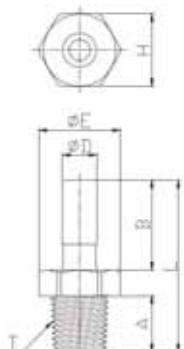

Adaptador con rosca macho cilíndrica BSPP • Stem adapter BSPP thread

HCJ-G	REFERENCIA	ØD	T	A	B	ØE	L	H (Hex)	Peso Weight(g)
	HCJ04G01W	4	G1/8"	6,0	18,0	16,6	32,5	15	2,6
	HCJ04G02W		G1/4"	8,5	18,0	20,5	35,0	18	4,2
	HCJ06G01W	6	G1/8"	6,0	19,5	16,6	34,0	15	2,8
	HCJ06G02W		G1/4"	8,5	19,5	20,5	36,5	18	4,3
	HCJ08G01W	8	G1/8"	6,0	21,0	16,6	35,5	15	3,0
	HCJ08G02W		G1/4"	8,5	21,0	20,5	38,0	18	4,6
	HCJ08G03W		G3/8"	9,0	21,0	24,2	38,5	22	6,2
	HCJ10G02W	10	G1/4"	8,5	24,0	20,5	41,0	18	5,3
	HCJ10G03W		G3/8"	9,0	24,0	24,2	41,5	22	6,8
	HCJ10G04W		G1/2"	12,5	24,0	28,5	45,0	26	10,6
	HCJ12G03W	12	G3/8"	9,0	28,0	24,2	45,5	22	7,3
	HCJ12G04W		G1/2"	12,5	28,0	28,5	49,0	26	11,0

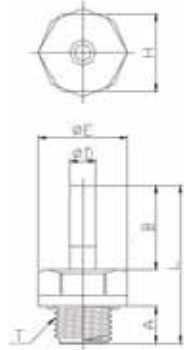

Reducción codo tubo • Reducer

HGJ	REFERENCIA	ØD1	ØD2	ØP	A	B	L	Peso Weight(g)
	HGJ0604W	6	4	10,5	21	14,7	36,7	2,4
	HGJ0806W	8	6	10,5	22,5	16,1	40,6	4
	HGJ1008W	10	8	12,5	24,8	17,5	43,8	6,3

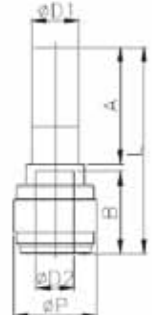

Codo con espiga • Elbow with dowel
HLJ

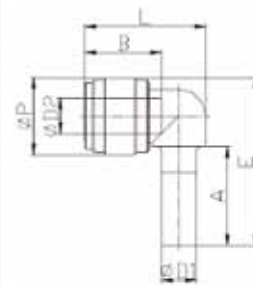

REFERENCIA	ØD1	ØD2	ØP	A	B	E	L	Peso Weight(g)
HLJ0404W	4	4	13,2	18	14,7	30,1	21,9	2,6
HLJ0606W	6	6	15,5	21	16,1	34,8	25,1	3,8
HLJ0808W	8	8	17,6	22,5	17,5	38,3	27,7	5,3
HLJ1010W	10	10	20	24,8	20,1	43,2	31,3	7,4
HLJ1212W	12	12	23,6	29,5	24,7	51,2	39	12,6

Unión • Union connector
HUC

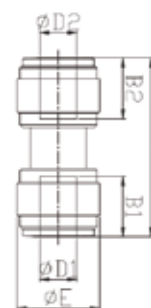

REFERENCIA	ØD1	ØD2	B1	B2	ØE	L	Peso Weight(g)
HUC0404W	4	4	14,7	14,7	13,2	31,8	3,8
HUC0604W	6	4	16,1	14,7	15	35	6,5
HUC0606W	6	6	16,1	16,1	15	35,2	4,8
HUC0806W	8	6	17,5	16,1	17,6	37,8	8
HUC0808W	8	8	17,5	17,5	17,6	38,2	6,9
HUC1008W	10	8	20,1	17,5	20	42,4	12
HUC1010W	10	10	20,1	20,1	20	42,7	9
HUC1210W	12	10	24,7	20,1	23	51,7	16,5
HUC1212W	12	12	24,7	24,7	23	52,4	14,2

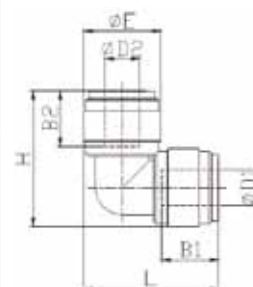
Unión codo • Union elbow
HUL



REFERENCIA	ØD1	ØD2	B1	B2	ØE	H	L	Peso Weight(g)
HUL0404W	4	4	14,7	14,7	13,2	24,5	24,5	3,9
HUL0606W	6	6	16,1	16,1	15	27,6	27,6	5
HUL0806W	8	6	17,5	16,1	17,6	30,3	30,7	8
HUL0808W	8	8	17,5	17,5	17,6	30,7	30,7	7,6
HUL1010W	10	10	20,1	20,1	20	35,8	35,8	10,1
HUL1212W	12	12	24,7	24,7	23	43,2	43,2	16,4

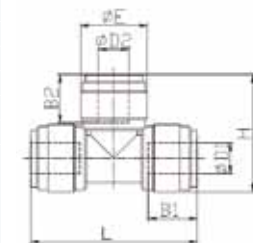

"T" tubo • Union tee
HUT

REFERENCIA	ØD1	ØD2	B1	B2	ØE	H	L	Peso Weight(g)
HUT0404W	4	4	14,7	14,7	13,2	24,5	35,8	5,8
HUT0606W	6	6	16,1	16,1	15	27,6	40,2	7,3
HUT0808W	8	8	17,5	17,5	17,6	30,7	43,8	10,6
HUT1010W	10	10	20,1	20,1	20	35,8	51,6	14,6
HUT1212W	12	12	24,7	24,7	23	43,2	63,4	23

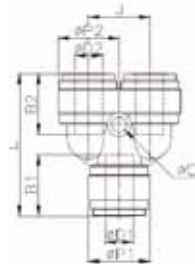

"Y" unión tubo tubo • Union Y

HUY	REFERENCIA	ØD1	ØD2	B1	B2	ØP1	ØP2	ØC	J	L	Peso Weight(g)
	HUY0404W	4	4	14,7	14,7	14,7	14,7	13,2	24,5	35,8	6
	HUY0606W	6	6	16,1	16,1	16,1	16,1	15	27,6	40,2	8
	HUY0808W	8	8	17,5	17,5	17,5	17,5	17,6	30,7	43,8	11
	HUY1010W	10	10	20,1	20,1	20,1	20,1	20	35,8	51,6	15
	HUY1212W	12	12	24,7	24,7	24,7	24,7	23	43,2	63,4	24



Clip de bloqueo • Locking clip

HCP	REFERENCIA	ØD	ØC	E	L	H	J	K	Peso Weight(g)
	HCP04W	4	6,2	10,2	11	2,8	4,3	1,1	0,2
	HCP06W	6	8	11,6	11	3,1	6,4	1,3	0,2
	HCP08W	8	9,6	13,5	13,9	3,3	7,3	1,4	0,2
	HCP10W	10	11,8	16	16,4	3,4	9,2	1,4	0,3
	HCP12W	12	14,4	19	19	3,6	11,1	1,4	0,5

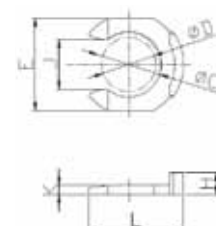

Válvula antirretorno • Check valve

HCVU	REFERENCIA	ØD	ØP	E	L	Peso Weight(g)
	HCVU0606W	6	15,5	16,1	45,5	7,5
	HCVU0808W	8	17,6	17,5	48,6	10
	HCVU1010W	10	20	19,4	57,6	14,8
	HCVU1212W	12	23,6	23,9	67,5	22,3

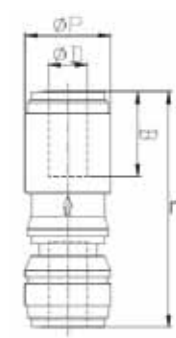

Válvula manual métrica • Metric manual valve

HBVU	REFERENCIA	ØD1	ØD2	B1	B2	ØP1	ØP2	L1	L2	E	C	Peso Weight(g)
	HBVU 0606	6	6	16,1	16,1	15,5	15,5	9,5	34,5	51,7	19,2	16
	HBVU 0808	8	8	17,5	17,5	17,6	17,6	9,5	34,5	53,5	19,2	17,4
	HBVU 1010	10	10	20,1	20,1	20	20	12,5	42,3	63	24,2	29
	HBVU 1212	12	12	23,7	23,7	23	23	12,5	42,3	70,4	24,2	35,4

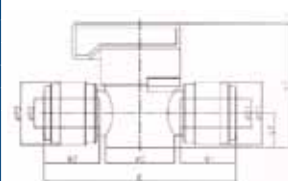

Tubo polietileno - métrica • Metric polyethylene tube

PE	REFERENCIA	O.D.	I.D. (mm)	Tolerancia	Max. Presión
	PE 0425	4	2,5	+/- 0,1	15,9 bar
	PE 0640	6	4	+/- 0,1	15,9 bar
	PE 0860	8	6	+/- 0,1	11,8 bar
	PE 1070	10	7	+/- 0,1	11,8 bar
	PE 1290	12	9	+/- 0,1	11,8 bar



NUEVO



PULGADAS - INCHES

Designación de la referencia - Model designation

Rosca NPT - NPT thread

HPC	5/32	N01																								
Código Code	Diámetro Tubo Tube diameter	Rosca Thread size																								
	<table border="1"> <thead> <tr> <th>Código</th> <th>Tubo</th> </tr> </thead> <tbody> <tr><td>5/32</td><td>Ø5/32</td></tr> <tr><td>3/16</td><td>Ø3/16</td></tr> <tr><td>1/4</td><td>Ø1/4</td></tr> <tr><td>5/16</td><td>Ø5/16</td></tr> <tr><td>3/8</td><td>Ø3/8</td></tr> <tr><td>1/2</td><td>Ø1/2</td></tr> </tbody> </table>	Código	Tubo	5/32	Ø5/32	3/16	Ø3/16	1/4	Ø1/4	5/16	Ø5/16	3/8	Ø3/8	1/2	Ø1/2	<table border="1"> <thead> <tr> <th colspan="2">Rosca NPT NPT thread</th> </tr> </thead> <tbody> <tr><td>N01</td><td>NPT1/8"</td></tr> <tr><td>N02</td><td>NPT1/4"</td></tr> <tr><td>N03</td><td>NPT 3/8"</td></tr> <tr><td>N04</td><td>NPT1/2"</td></tr> </tbody> </table>	Rosca NPT NPT thread		N01	NPT1/8"	N02	NPT1/4"	N03	NPT 3/8"	N04	NPT1/2"
Código	Tubo																									
5/32	Ø5/32																									
3/16	Ø3/16																									
1/4	Ø1/4																									
5/16	Ø5/16																									
3/8	Ø3/8																									
1/2	Ø1/2																									
Rosca NPT NPT thread																										
N01	NPT1/8"																									
N02	NPT1/4"																									
N03	NPT 3/8"																									
N04	NPT1/2"																									

Datos Técnicos						
Fluidos compatibles	Agua, bebidas, aire comprimido, vacío, gases y líquidos adecuados con materiales de construcción seleccionados					
Materiales utilizados	Cuerpo: POM					
	Pinza: POM + SUS 301					
	Juntas: EPDM idóneo para el contacto con alimento					
Roscas	NPT de 1/8" a 1/2"					
Par máximo	1/8" y 1/4": 1,5 N/m					
	3/8" y 1/2": 3 N/m					
Presión de trabajo	de -750mmHg a 20 bar					
Temperatura de trabajo	Hasta 98°C					
°C/MM	4	6	8	10	12	
1°C *	20bar	20bar	20bar	16bar	14bar	
25°C *	20bar	20bar	20bar	16bar	14bar	
70°C *	16bar	16bar	16bar	14bar	12bar	
98°C *	10bar	10bar	10bar	8bar	6bar	
Tubos utilizados	Plásticos: Poliamida (PA)-Polietileno (PE)-PUES-PUET-PTFE-FEP (tolerancia ±0,1mm)					
	Metálicos: Latón, cobre. Consultar a nuestro departamento técnico para tubos en acero inoxidable y otros materiales.					
Producto conforme a la directiva 2002/95/EC 						
Producto conforme a la directiva 1907/2006 						

Technical specifications						
Fluids	Fluid types water, beverages, compressed air, vacuum, selected gases & liquids suitable with construction materials					
Materials used	Body: POM					
	Collet: POM + SUS 301					
	Seals: EPDM suitable for food contact					
Threads	NPT from 1/8" to 1/2"					
Max torque	1/8" & 1/4": 1,5 N/m					
	3/8" & 1/2": 3 N/m					
Working pressure	From -750mmHg to 20 bar					
Working temperature	Up to 98°C					
°C/MM	4	6	8	10	12	
1°C *	20bar	20bar	20bar	16bar	14bar	
25°C *	20bar	20bar	20bar	16bar	14bar	
70°C *	16bar	16bar	16bar	14bar	12bar	
98°C *	10bar	10bar	10bar	8bar	6bar	
Tubes used	Plastics: Polyamide (PA)-Polyethylene (PE)-PUES-PUET-PTFE-FEP (tolerance ±0,1mm)					
	Metals: Brass, copper. Please contact our technical department for stainless steel and other materials.					
Products in conformity with the directive 2002/95/EC 						
Products in conformity with the directive 1907/2006 						

Conexión macho NPT • Male plug NPT

HPC	REFERENCIA	ØD	T	A	B	ØE	L	H (Hex)	Peso Weight(g)
	HPC5/32 N01	5//32	NPT1/8	9,1	14,7	17,8	15,8(5/8)	22,2	3,2
	HPC5/32 N02	5//32	NPT1/4	13,2	14,7	17,8	15,8(5/8)	25,3	4,3
	HPC3/16 N01	3//16	NPT1/8	9,1	15	17,8	15,8(5/8)	22,4	3,1
	HPC3/16 N02		NPT1/4	13,2	15	17,8	15,8(5/8)	25,5	4,2
	HPC1/4 N01	1//4	NPT1/8	9,1	16,9	17,8	15,8(5/8)	27	3,9
	HPC1/4 N02		NPT1/4	13,2	16,9	17,8	15,8(5/8)	27	4,3
	HPC1/4 N03		NPT3/8	13,8	16,9	21,4	19(3/4)	26,1	6,1
	HPC5/16 N01	5//16	NPT1/8	9,1	17,5	21,4	19(3/4)	28,4	5,6
	HPC5/16 N02		NPT1/4	13,2	17,5	21,4	19(3/4)	27,9	5,2
	HPC5/16 N03		NPT3/8	13,8	17,5	21,4	19(3/4)	26,5	6
	HPC5/16 N04		NPT1/2	17,8	17,5	25	22,2(7/8)	33,5	11,5
	HPC3/8 N01	3//8	NPT1/8	9,1	20,2	23	20,6(13/16)	30,4	6,7
	HPC3/8 N02		NPT1/4	13,2	20,2	23	20,6(13/16)	34,3	7,9
	HPC3/8 N03		NPT3/8	13,8	20,2	23	20,6(13/16)	29,9	7,5
	HPC3/8 N04		NPT1/2	17,8	20,2	25	22,2(7/8)	33,9	11
	HPC1/2 N03	1//2	NPT3/8	13,8	25,1	27,4	24,5(31/32)	38,4	11,7
HPC1/2 N04	NPT1/2		17,8	25,1	27,4	24,5(31/32)	37,9	12,7	

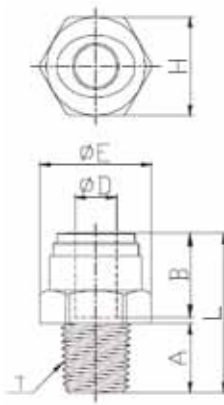

Conexión rosca macho cilíndrica BSPP en pulgadas con OR • Male BSPP thread plug with OR in inches

HPC-G	REFERENCIA	ØD	T	A	B	ØE	L	H (Hex)	Peso Weight(g)
	HPC1/4-G01	1/4	G 1/8	6,0	16,9	16,5	24,1	15	3,6
	HPC1/4-G02	1/4	G 1/4	8,5	16,9	20,5	24,1	18,0	4,7
	HPC5/16-G03	5/16	G 3/8	9,0	16,9	24,0	26,5	21,0	7,0
	HPC3/8-G02	3/8	G 1/4	8,5	20,2	21,1	30,9	19,0	7,3
	HPC3/8-G03	3/8	G 3/8	8,5	20,2	24,2	26,4	21,0	7,1

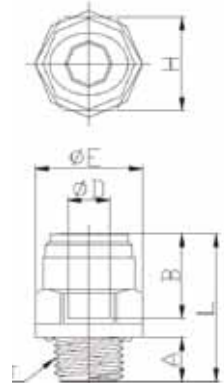

Codo rosca macho NPT • Male elbow NPT thread

HPL	REFERENCIA	ØD	T	A	B	ØE	L	H (Hex)	Peso Weight(g)
	HPL5/32 N01	5//32	NPT1/8	9,1	14,7	26,4	11(7/16)	25,4	4,9
	HPL3/16 N01	3//16	NPT1/8	9,1	15	26,4	11(7/16)	25,6	4,7
	HPL1/4 N01	1//4	NPT1/8	9,1	16,9	26,4	11(7/16)	25,6	4,2
	HPL1/4 N02		NPT1/4	13,2	16,9	31,9	11(7/16)	27	5,7
	HPL1/4 N03		NPT3/8	13,8	16,9	32,7	11(7/16)	28,9	7,1
	HPL5/16 N02	5//16	NPT1/4	13,2	17,5	35,2	14,3(9/16)	31,4	9
	HPL5/16 N03		NPT3/8	13,8	17,5	35,8	14,3(9/16)	33,5	10,3
	HPL3/8 N02	3//8	NPT1/4	13,2	20,2	35,2	14,3(9/16)	31,8	8,6
	HPL3/8 N03		NPT3/8	13,8	20,2	35,8	14,3(9/16)	33,9	9,9
	HPL1/2 N03	1//2	NPT3/8	13,8	25,1	39,3	17,4(11/16)	39,7	13,3
HPL1/2 N04	NPT1/2		17,8	25,1	43,3	17,4(11/16)	41,5	16,2	

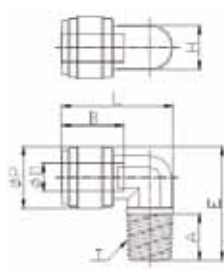

Pasatabiques pulgadas • Inch bulkhead

HMM	REFERENCIA	ØD1	ØD2	T	A	E	B1	B2	H1 (Hex)	H2 (Hex)	L	Peso Weight(g)
	HMM5/32 5/32	5/32	5/32	M15x1,5	8,1	6,5	14,7	14,7	17	18	32,4	6,9
	HMM1/4 1/4	1/4	1/4	M17x1,5	9,4	7	16,9	16,9	19	21	35,7	9,4
	HMM5/16 5/16	5/16	5/16	M20x1,75	9,4	8	17,5	17,5	21	25,5	38,5	14,2
	HMM3/8 3/8	3/8	3/8	M24x1,75	11,1	8,5	20,2	20,2	24	25,5	42,4	20,1
	HMM1/2 1/2	1/2	1/2	M27x2	16,4	9	25,1	25,1	27	31	51,8	27,6

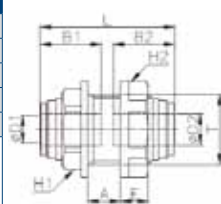

Adaptador con rosca macho NPT • Stem adapter NPT thread

HCJ	REFERENCIA	ØD	T	A	B	ØE	L	H (Hex)	Peso Weight(g)
	HCJ5/32-N01	5/32	NPT 1/8	9,1	18,0	14,1	33,1	12,7 (1/2)	1,9
	HCJ5/32-N02	5/32	NPT 1/4	13,2	18,0	17,8	37,2	15,8 (5/8)	3,6
	HCJ3/16-N01	3/16	NPT 1/8	9,1	18,0	14,1	33,1	12,7 (1/2)	2,0
	HCJ1/4-N01	1/4	NPT 1/8	9,1	19,0	14,1	34,1	12,7 (1/2)	2,1
	HCJ1/4-N02	1/4	NPT 1/4	13,2	19,0	17,8	38,2	15,8 (5/8)	3,8
	HCJ5/16-N01	5/16	NPT 1/8	9,1	20,0	14,1	35,1	12,7 (1/2)	2,8
	HCJ5/16-N02	5/16	NPT 1/4	13,2	20,0	17,8	39,2	15,8 (5/8)	3,9
	HCJ5/16-N03	5/16	NPT 3/8	13,8	20,0	21,5	40,3	19,0 (3/4)	5,9
	HCJ3/8-N02	3/8	NPT 1/4	13,2	23,0	17,8	42,2	15,8 (5/8)	4,5
	HCJ3/8-N03	3/8	NPT 3/8	13,8	23,0	21,5	43,3	19,0 (3/4)	6,5
	HCJ1/2-N03	1/2	NPT 3/8	13,8	27,0	21,5	47,3	19,0 (3/4)	6,9
	HCJ1/2-N04	1/2	NPT 1/2	17,8	27,0	26,8	51,3	23,8 (15/16)	11,4

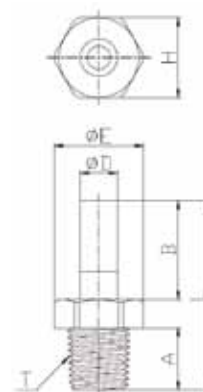

Reducción codo tubo pulgadas • Inch reducer

HGJ	REFERENCIA	ØD1	ØD2	ØP	A	B	L	Peso Weight(g)
	HGJ5/16 1/4	5/16	1/4	15,5	22,5	16,9	40,6	3,4
	HGJ1/4 5/32	1/4	5/32	13,2	21,0	14,7	36,7	2,4

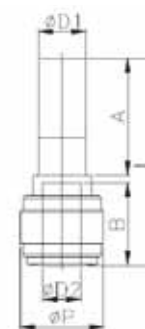

Codo con espiga pulgadas • Inch elbow with dowel

HLJ	REFERENCIA	ØD1	ØD2	ØP	A	B	E	L	Peso Weight(g)
	HLJ5/32-5/32	5/32	5/32	13,2	18,0	14,7	30,1	21,9	2,5
	HLJ3/16-3/16	3/16	3/16	13,8	18,5	15,0	31,4	22,5	2,9
	HLJ1/4-1/4	1/4	1/4	15,5	21,0	16,9	34,8	25,1	3,7
	HLJ3/8-1/4	3/8	1/4	17,6	22,5	17,5	38,3	27,7	5,4
	HLJ5/16-5/16	5/16	5/16	15,5	24,8	16,9	38,6	25,1	4,5
	HLJ3/8-5/16	3/8	5/16	20,0	24,8	17,5	43,2	31,0	8,1
	HLJ3/8-3/8	3/8	3/8	20,0	24,8	20,2	43,2	31,4	7,9
	HLJ1/2-1/2	1/2	1/2	23,6	29,5	25,1	51,2	39,2	12,7

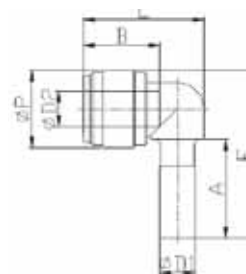

Unión pulgadas • Inch union connector

HUC	REFERENCIA	ØD1	ØD2	ØP	A	B	L	Peso Weight(g)
	HUC5/32-5/32	5/32	5/32	14,7	14,7	13,2	31,8	3,8
	HUC3/16-3/16	3/16	3/16	15,0	15,0	13,8	32,5	4,0
	HUC1/4-1/4	1/4	1/4	16,9	16,9	15,5	36,2	5,2
	HUC5/16-1/4	5/16	1/4	17,5	16,9	17,6	36,8	6,0
	HUC5/16-5/16	5/16	5/16	17,5	17,5	17,6	38,2	6,9
	HUC3/8-1/4	3/8	1/4	20,2	16,9	20,0	42,1	9,9
	HUC3/8-5/16	3/8	5/16	20,2	17,5	20,0	42,5	9,9
	HUC3/8-3/8	3/8	3/8	20,2	20,2	20,0	42,9	9,7
	HUC1/2-5/16	1/2	5/16	25,1	17,5	23,6	52,0	16,7
	HUC1/2-3/8	1/2	3/8	25,1	20,2	23,6	52,4	16,3
	HUC1/2-1/2	1/2	1/2	25,1	25,1	23,6	53,2	14,6

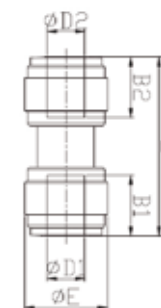

Unión codo pulgadas • Inch unión elbow

HUL	REFERENCIA	ØD1	ØD2	B1	B2	ØE	H	L	Peso Weight(g)
	HUL5/32-5/32	5/32	5/32	14,7	14,7	13,2	24,5	24,5	4,0
	HUL3/16-3/16	3/16	3/16	15,0	15,0	13,8	25,5	25,5	4,3
	HUL1/4-1/4	1/4	1/4	16,9	16,9	15,5	28,8	28,8	5,5
	HUL5/16-1/4	5/16	1/4	17,5	16,9	17,6	30,7	30,3	7,6
	HUL5/16-5/16	5/16	5/16	17,5	17,5	17,6	30,7	30,7	7,5
	HUL3/8-5/16	3/8	5/16	20,2	17,5	20,0	35,9	35,5	11,1
	HUL3/8-3/8	3/8	3/8	20,2	20,2	20,0	35,9	35,9	10,6
	HUL1/2-3/8	1/2	3/8	25,1	20,2	23,0	43,4	42,6	17,5
	HUL1/2-1/2	1/2	1/2	25,1	25,1	23,0	43,4	43,4	16,7



“T” tubo pulgadas • Inch unión tee

HUT	REFERENCIA	ØD1	ØD2	B1	B2	ØE	H	L	Peso Weight(g)
	HUT5/32-5/32	5/32	5/32	14,7	14,7	13,2	24,5	35,8	5,7
	HUT3/16-3/16	3/16	3/16	15,0	15,0	13,8	25,5	37,2	6,2
	HUT1/4-1/4	1/4	1/4	16,9	16,9	15,5	28,8	42,0	8,1
	HUT5/16-5/16	5/16	5/16	17,5	17,5	17,6	30,7	43,8	10,6
	HUT3/8-3/8	3/8	3/8	20,2	20,2	20,0	35,9	51,8	15,4
	HUT1/2-1/2	1/2	1/2	25,1	25,1	23,0	43,4	63,8	23,2

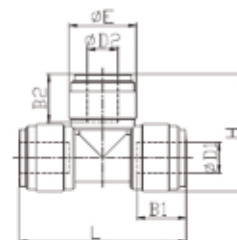

“Y” unión tubo tubo pulgadas • Inch union Y

HUY	REFERENCIA	ØD1	ØD2	B1	B2	ØP1	ØP2	ØC	J	L	Peso Weight(g)
	HUY5/32-5/32	5/32	5/32	14,7	14,7	13,8	13,8	3,3	13,5	33,7	6,7
	HUY3/16-3/16	3/16	3/16	15,0	15,0	13,8	13,8	3,3	13,5	34,1	6,8
	HUY1/4-1/4	1/4	1/4	16,9	16,9	15,5	15,5	3,3	15,5	38,8	8,8
	HUY5/16-5/16	5/16	5/16	17,5	17,5	17,6	17,6	4,5	17,6	41,0	11,8
	HUY3/8-3/8	3/8	3/8	20,2	20,2	20,0	20,0	4,5	20,0	46,4	16,7
	HUY1/2-1/2	1/2	1/2	25,1	25,1	23,0	23,0	4,5	23,0	56,8	25,1



Clip de bloqueo pulgadas • Inch locking clip

HCP	REFERENCIA	ØD	ØC	E	L	H	J	K	Peso Weight(g)
	HCP5/32	5/32	6,2	10,2	11,0	2,8	4,3	1,1	0,09
	HCP3/16	3/16	6,2	10,2	11,0	2,8	4,3	1,1	0,09
	HCP1/4	1/4	8,0	11,6	11,6	3,1	6,4	1,3	0,12
	HCP5/16	5/16	9,6	13,5	13,9	3,3	7,3	1,4	0,16
	HCP3/8	3/8	11,8	16,0	16,4	3,4	9,2	1,4	0,23
	HCP1/2	1/2	14,4	19,0	19,0	3,6	11,1	1,4	0,30

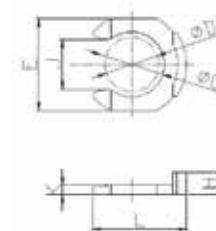

Adaptador rosca cilíndrica BSPP pulgadas • Inch female adapter BSPP thread

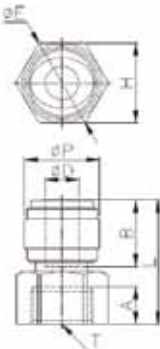
HCF	REFERENCIA	ØD1	ØD2	ØP	A	B	E	L	Peso Weight(g)	
	HCF3/8G04	3/8	G1/2	12,5	20,2	30	38,4	27	13,4	

Válvula antirretorno pulgadas • Inch check valve

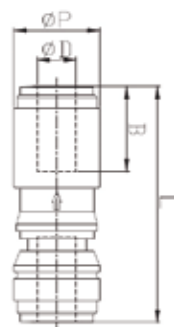
HCVU	REFERENCIA	ØD	ØP	E	L	Peso Weight(g)	
	HCVU1/4-1/4	1/4	15,5	45,5	16,1	7,4	
	HCVU5/16-5/16	5/16	17,6	48,6	17,5	10,0	
	HCVU3/8-3/8	3/8	20,0	57,8	19,5	15,0	
	HCVU1/2-1/2	1/2	23,6	67,9	24,1	21,5	

Válvula manual pulgadas • Inch manual valve

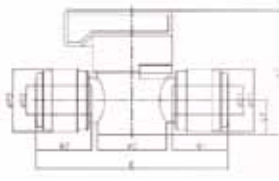
HBVU	REFERENCIA	ØD1	ØD2	B1	B2	ØP1	ØP2	L1	L2	E	C	Peso Weight(g)	
	HBVU1/4-1/4	1/4	1/4	16,1	16,1	15,5	15,5	9,5	34,5	51,7	19,2	16,0	
	HBVU5/16-5/16	5/16	5/16	17,5	17,5	17,6	17,6	9,5	34,5	53,5	19,2	17,4	
	HBVU3/8-3/8	3/8	3/8	20,2	20,2	20,0	20,0	12,5	42,3	63,2	24,2	29,0	
	HBVU1/2-1/2	1/2	1/2	23,9	23,9	23,0	23,0	12,5	42,3	70,8	24,2	35,4	

Tubo polietileno - pulgadas • Inch polyethylene tube

PE	REFERENCIA	O.D.	I.D. (mm)	Tolerancia	Max. Presión
	PE5/32	5/32	3,97	+/- 0,1	15,9 bar
	PE3/16	3/16	4,76	+/- 0,1	15,9 bar
	PE1/4	1/4	6,35	+/- 0,1	15,9 bar
	PE5/16	5/16	7,94	+/- 0,1	11,8 bar
	PE3/8	3/8	9,52	+/- 0,1	11,8 bar
	PE1/2	1/2	12,7	+/- 0,1	11,8 bar

NUEVO

Designación de la referencia - Model designation

IMOTEC	04 06	01 M6																		
Código Code	Diámetro Tubo Tube diameter	Rosca Thread size																		
	<table border="1"> <tr><th>Código</th><th>Tubo</th></tr> <tr><td>04</td><td>4mm</td></tr> <tr><td>06</td><td>6mm</td></tr> </table>	Código	Tubo	04	4mm	06	6mm	<table border="1"> <tr><th colspan="2">Cónica BSPT BSPT thread</th></tr> <tr><td>01</td><td>R1/8"</td></tr> <tr><th colspan="2">Métrica Metric thread</th></tr> <tr><td>M6</td><td>M6</td></tr> <tr><td>M8</td><td>M8</td></tr> <tr><td>M10</td><td>M10</td></tr> </table>	Cónica BSPT BSPT thread		01	R1/8"	Métrica Metric thread		M6	M6	M8	M8	M10	M10
Código	Tubo																			
04	4mm																			
06	6mm																			
Cónica BSPT BSPT thread																				
01	R1/8"																			
Métrica Metric thread																				
M6	M6																			
M8	M8																			
M10	M10																			

Componentes - Construction

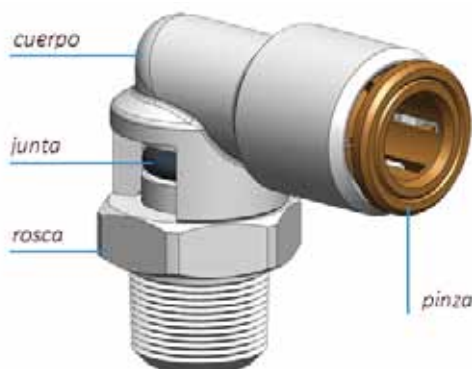

Datos Técnicos

Aplicaciones	Sistemas de lubricación
Materiales utilizados	Cuerpo: Latón UNI EN 12164 CW614N-UNI EN 12165 CW617N niquelado
	Rosca: Latón UNI EN 12164 CW614N niquelado
	Pinza de sujeción: Latón UNI EN 12164 CW614N
	Juntas: NBR
Presión de trabajo	Max 80 bar. La tasa de presión max puede variar dependiendo de la tubería utilizada y de la temperatura ambiente. Estos dos factores pueden de hecho bajar la presión de rotura del tubo.
Temperatura de trabajo	de -20°C a 70°C
Tolerancias aceptables del tubo	±0,07 mm para tubos hasta ø 6 mm
Profundidad de inserción del tubo	14,5 mm para ø4 mm
	17 mm para ø6 mm
Tubos utilizados	Poliamida (PA)
Producto conforme a la directiva 2002/95/EC	
Producto conforme a la directiva 1907/2006	

Technical specifications

Applications	Lubrication installations
Materials used	Body: Brass UNI EN 12164 CW614N-UNI EN 12165 CW617N Nickel plated
	Threaded screws: Brass UNI EN 12164 CW614N nickel plated
	Gripping collet: Brass UNI EN 12164 CW614N
	Seals: NBR
Working pressure	Max 80 bar. The max pressure rate archivable can vary depending on the tubing used and the room temperature. These two factors may in fact lower the tube bursting pressure.
Working temperature	From -20°C to 70°C
Acceptable tolerances on the tubings	±0,07 mm up to ø 6 mm
Tubing insertion depth	14,5 mm for ø4 mm
	17 mm for ø6 mm
Tubes used	Polyamide (PA)
Products in conformity with the directive 2002/95/EC	
Products in conformity with the directive 1907/2006	

Unión simple rosca macho cónica BSPT y métrica • Taper straight male BSPT & metric

IMOTEC	REFERENCIA	ØD	T	ØP	I	L	H (Hex)	Peso Weight(g)
	IMOTEC0401	4	R1/8"	9	7,5	18,5	10	7,2
	IMOTEC04M6		M6x1	9	8	23	10	7,6
	IMOTEC04M8		M8x1	9	8	20	10	6,7
	IMOTEC04M10		M10x1	9	8	20	11	9,3
	IMOTEC0601	6	R1/8"	12	7,5	21,5	12	10,3
	IMOTEC06M6		M6x1	12	8	25,5	12	11,6
	IMOTEC06M8		M8x1	12	8	25,5	12	12,3
	IMOTEC06M10		M10x1	12	8	22	12	10,9
	IMOTEC0801	8	R 1/8"	14	7,5	25,5	14	--
	IMOTEC0802		R 1/4"	14	11	25,5	14	--
IMOTEC08M10	M10x1		14	8	26	14	--	



Codo rosca macho cónica BSPT y métrica • Taper elbow fitting male BSPT & metric

IMOTEL	REFERENCIA	ØD	T	ØP	I	L1	L2	H (Hex)	Peso Weight(g)
	IMOTEL0401	4	R1/8"	9	7,5	15,5	20	10	12,6
	IMOTEL04M6		M6x1	9	8	17	20	10	13,3
	IMOTEL04M8		M8x1	9	8	17	20	10	13,4
	IMOTEL04M10		M10x1	9	8	18	20	10	14,3
	IMOTEL0601	6	R1/8"	12	7,5	15,5	21	10	14,2
	IMOTEL06M6		M6x1	12	8	17	21	10	14,6
	IMOTEL06M8		M8x1	12	8	17	21	10	14,8
	IMOTEL06M10		M10x1	12	8	18	21	10	15,8
	IMOTEL0801	8	R 1/8"	14	7,5	19	23,5	12	--
	IMOTEL0802		R 1/4"	14	11	20	23,5	12	--
	IMOTEL08M10		M10x1	14	8	19	23,5	12	--

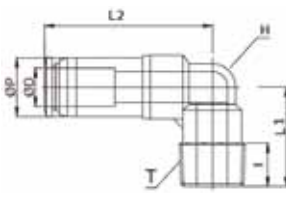

Codo giratorio rosca macho cónica BSPT y métrica • Taper swivelling elbow fitting male BSPT & metric

IMOTELG	REFERENCIA	ØD	T	ØP	I	L1	L2	H (Hex)	Peso Weight(g)
	IMOTELG0401	4	R1/8"	9	7,5	20	20	13	21,9
	IMOTELG04M6		M6x1	9	8	20,5	20	13	19,9
	IMOTELG04M8		M8x1	9	8	20,5	20	13	20,7
	IMOTELG04M10		M10x1	9	8	21,5	20	13	23,4
	IMOTELG0601	6	R1/8"	12	7,5	20	21,5	13	24,2
	IMOTELG06M6		M6x1	12	8	20,5	21,5	13	21,7
	IMOTELG06M8		M8x1	12	8	20,5	21,5	13	22,6
	IMOTELG06M10		M10x1	12	8	21,5	21,5	13	25,8
	IMOTELG0801	8	R 1/8"	14	7,5	20,5	23	13	--
	IMOTELG0802		R 1/4"	14	11	24	23	13	--
	IMOTELG08M10		M10x1	14	8	22	23	13	--

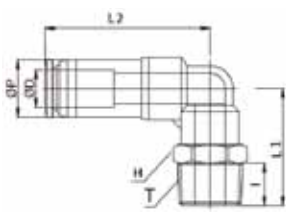

Unión tubo tubo • Union

IMOTEU	REFERENCIA	ØD	ØP	L	Peso Weight(g)
	IMOTEU04	4	9	30	10,7
	IMOTEU06	6	12	33,5	15,7
	IMOTEU08	8	14	36	--

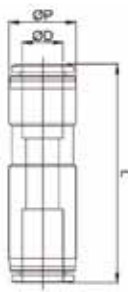

Tubería de Poliamida • Polyamide tube

TP	Ø TUBO EXT X INT (MM)	PRESIÓN DE TRABAJO A 23 °C (BAR)	RADIO MÍNIMO DE CURVATURA (MM)	COLOR	REFERENCIA ROLLOS DE 100 M.
	4 x 2	45	20	Blanco / White Negro / Black	TP-2x4-B TP-2x4-NE
	6 x 3	44	30	Negro / Black	TP-6x3-NE
	8x4	44	40	Negro/Black	TP-8x4-NE
	8x5	31	40	Negro/Black	TP-8x5-NE





RACORES FUNC. NEUMÁTICAS *Function fittings*

REGULADORES DE CAUDAL TIPO BANJO · *Banjo flow regulators*

NUEVO REGULADORES DE CAUDAL CON VÁLVULA DE BLOQUEO PILOTADA

Flow regulators with pilot check valve

REGULADORES DE CAUDAL EN LÍNEA · *Flat flow regulators*

VÁLVULAS DE ESCAPE RÁPIDO · *Quick exhaust valve*

NUEVO VÁLVULAS MANUALES 3/2 VÍAS · *Hand valves 3/2 lines*

NUEVO VÁLVULAS DE SEGURIDAD TARADAS · *Safety tares valves*

NUEVO VÁLVULAS CON INTERRUPTOR NEUMÁTICO · *Pneumatics valve switch*

NUEVO MANÓMETRO EN LÍNEA · *Pressure gauge*

VÁLVULAS DE CORREDERA · *Slide valves*

VÁLVULAS DE CORREDERA CON BLOQUEO DE SEGURIDAD

Slide valves with security block

VÁLVULAS DE BLOQUEO · *Stop fittings*

VÁLVULAS ANTIRRETORNO · *Check values*

Designación Referencia - Model designation

**IMONSE
IMONTSC**

Código
Code

04

Diámetro Tubo
Tube diameter

**01
G01**

Rosca
Thread size

D

Tipo de regulación
Type of regulation

F

Tipo de rosca
Connection method

C

Regulación del fluido
Flow direction

Materiales utilizados
Material used

NS: Termoplástico BT
OT: Latón - brass

Código	Tubo
03	3mm
04	4mm
06	6mm
08	8mm
10	10mm
12	12mm

Cónica BSPT BSPT thread	
01	1/8"
02	1/4"
03	3/8"
04	1/2"

Métrica Metric Thread	
M5	M5x0,8

Cilíndrica BSPP BSPP thread	
G01	G1/8"
G02	G1/4"
G03	G3/8"
G04	G1/2"

D: Mediante tornillo
screwdriver

F: Hembra
Female thread

C: Para cilindro
C: For cylinders

V: Para válvula
V: For valves

B: Bidireccional
B: Bidirectional



INSTRUCCIONES PARA EL CORRECTO USO DEL RACOR

- No utilizar el racor con otros fluidos distintos al aire comprimido.
- Contactar con el Departamento Técnico de IMOPAC, para el uso del racor con otros fluidos.
- Se recomienda prevenir eventuales aumentos de la presión, vibraciones y rotaciones del racor.
- No utilizar el racor en ambientes donde estén presentes chispas de soldadura.
- Vibraciones o rotaciones inapropiadas del racor, comprometen la funcionalidad del mismo y pueden causar fugas.
- No utilizar el racor expuesto directamente a fluidos como taladrina, aceite refrigerante y lubricantes.
- Introducir la tubería en el racor una vez limpia de impurezas, polvo y suciedad.

ATENCIÓN

- Cortar el tubo a 90° mediante la utilización de un cortatubo adecuado.
- Introducir el tubo hasta el tope del racor y tirar de la tubería hacia atrás para asegurar que ha sido correctamente insertada y no se escapa.
- Evitar ralladuras e imperfecciones de la superficie del tubo, deformaciones o un aspecto ovalado ya que puede producir fugas y desconexiones imprevistas.
- El diámetro exterior del tubo de poliuretano, puede expandirse en función de la temperatura y la presión aplicada. En estos casos la reinsertión del racor podría no ser posible, comprobar el diámetro exterior del tubo y sustituirlo por otro nuevo.

RECOMENDACIONES PARA LA CONEXIÓN DEL TUBO AL RACOR

- Asegurarse que la presión es cero antes de hacer la conexión del tubo al racor.
- Para desconectar el tubo presionar el anillo pulsador hasta el final y tirar del tubo con la mano.
- Cortar la parte del tubo sujeta al racor para posteriores reutilizaciones del mismo.

WARNING FOR FITTINGS RIGHT USE

- Do not use them on fluids other than indicated.
- Contact IMOPAC for use on other fluids.
- Be sure to prevent pressure buildup caused by twisting, pulling and bending of the fitting
- Do not use the product where weld spatters occur as fire may break out.
- Product damage or air leakage may occur at places where there is rotation and vibration, choose the right product from our catalogue.
- Do not use the product where it is directly exposed to fluids such as cutting oil, lubricating oil and coolant oil.
- Assemble the pipes only after clearing away impurities such as dust.

CAUTION FOR THE INSERTION OF THE TUBE TO THE FITTING PRODUCT

- Make sure the tube is inserted fully to the end of the fitting.
- To insert the tube into the fitting, cut the tube at a right angle 90°, insert it to the end and pull the tube gently to make sure it isn't released.
- If there are any damages or scratches on the tube surface or an oval shape, air leakage and tube release may occur. Check it meticulously.
- The OD of polyurethane tube expands by pressure applied on them. reinsertion to the fitting may not be possible. Check the OD of the tube and change the tube if the expansion is serious.

CAUTION FOR THE INSERTION OF THE TUBE TO THE FITTING PRODUCT

- Make sure the pressure is zero before releasing the tube from the fitting product.
- To release the tube, press the release ring regularly at the end and pull the tube with one hand.
- Cut the pressed part of the tube for reuse of the released tube.

REGULADORES EN TERMOPLÁSTICO - TERMOPLASTIC FLOW REGULATORS

Componentes - Construction

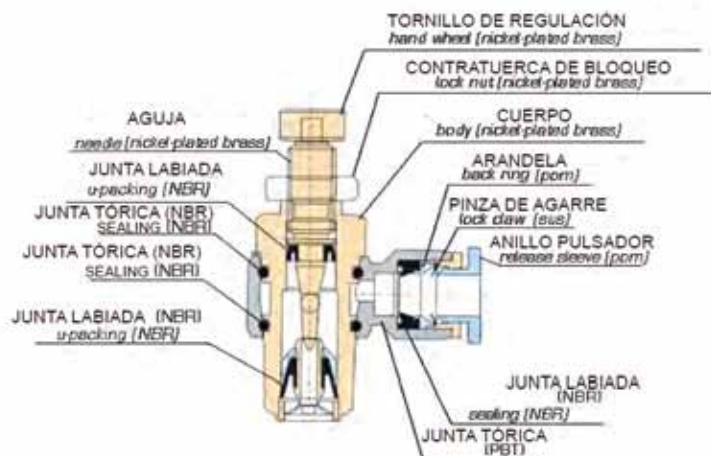

Versión descarga - C
"exhaust" version - C

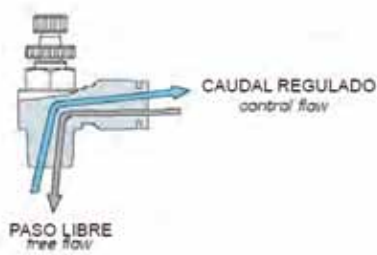

Versión alimentación - V
"supply" version - V



Datos Técnicos	
Aplicaciones	Neumática
Materiales utilizados	Cuerpo: latón niquelado y PBT
	Pinza de agarre: acero inox SUS 301
	Junta tórica: NBR sin silicona
Tipo de Regulación	Manual
Roscas	Gas cónica BSPT de R1/8" a R1/2" preteflonada
	Métrica M5
	Gas cilíndrica BSPP con J.T de G1/8" a G1/2"
Presión de trabajo	De 1 a 10 bar / de 0 a 150 psi
Presión de vacío	-750mmHG (-750 torr)
Temperatura de trabajo	De 0°C a 60°C
Tubos utilizados	Poliamida (PA)
	Poliuretano (PU)
	Poliétileno (PE)
Producto conforme a la directiva 2002/95/EC	

Technical specifications	
Applications	Pneumatics
Materials Used	Body: nickel plated brass & PBT
	Lock claw: steel SUS 301
	O'ring: NBR silicon free
Type of regulation	Manual for NSC & NSC-G
Threads	BSPT from R1/8" to R1/2" teflon coated
	Metric M5
	BSPP with OR from G1/8" to G1/2"
Working pressure	From 0 to 150 psi / from 1 to 10 Bar
Negative pressure	-29,5 in Hg / -750mmHG (-750 torr)
Working temperature	From 32 to 140 °F / from 0°C to 60°C
Tubes used	Polyamide (PA)
	Polyurethane (PU)
	Polyethylene (PE)
Products in conformity with the directive 2002/95/EC	

REGULADORES DE LATÓN - BRASS FLOW REGULATORS

Datos Técnicos	
Aplicaciones	Neumática y fluidos, consultar compatibilidades
Materiales utilizados	Cuerpo: latón niquelado UNI EN 12164 CW614N
	Pinza de agarre: acero inox Aisi 304
	Junta tórica: NBR sin silicona
Tipo de Regulación	Manual: IMOTSC
	A tornillo: IMOTSC-DC y IMOTSC-DF
Roscas	BSPP cilíndrica con junta tórica
Presión de trabajo	De tubo Ø 4mm a Ø 8mm: 15 Bar hasta 50°C y 10 Bar +50°C
	Tubo Ø 10mm: 10 Bar hasta 50°C y 6 Bar +50°C
Temperatura de trabajo	De -20°C a + 70°C
Tubos utilizados	Poliamida (PA)
	Poliuretano (PU)
	Poliétileno (PE)
Producto conforme a la directiva 2002/95/EC RoHS	

Technical specifications	
Applications	Air and other fluids on demand
Materials Used	Body: brass UNI EN 12164 CW614N
	Lock claw: stainless steel AISI 304
	O'ring: NBR silicon free
Type of regulation	Manual for IMOTSC-C
	Screwdriver: IMOTSC-DC & IMOTSC-DF
Threads	BSPP with OR from G1/8" to G1/2"
Working pressure	From tube Ø 4mm to Ø 8mm: 15 Bar up to 50°C & 10 Bar >50°C
	Tube Ø 10mm: 10 Bar up to 50°C & 6 Bar >50°C
Working temperatura	From -20°C to 70°C
Tubes used	Polyamide (PA)
	Polyurethane (PU)
	Polyethylene (PE)
Products in conformity with the directive 2002/95/EC RoHS	

REGULADORES DE ACERO INOX AISI 316 - INOX AISI 316 FLOW REGULATORS
AISI 316

Datos Técnicos	
Aplicaciones	Neumática y fluidos en el sector alimentario, químico, medicinal, farmacéutico y naval
Materiales utilizados	Cuerpo: acero INOX AISI 316
	Pinza de agarre: acero INOX AISI 303
	Junta tórica: vitón
Tipo de Regulación	A tornillo XSC-D y XSC-DF
Roscas	Métrica M5
	BSPP cilíndrica con junta tórica
Presión de trabajo	Hasta 10 Bar
Temperatura de trabajo	Hasta 120 °C
Tubos utilizados	Poliamida (PA)
	Poliuretano (PU)
	Poliétileno (PE)
	PTFE Calibrado
	Fluoropolímero FEP 140
	Tubo en acero inox (acanalado el extremo para facilitar el agarre)
Producto conforme a la directiva 2002/95/EC RoHS	

Technical specifications	
Applications	Pneumatics, fluids, food, chemical, medical, pharmaceutical & marine applications
Materials Used	Body: stainless steel AISI 316
	Lock claw: stainless steel AISI 303
	O'ring: viton
Type of regulation	Screwdriver: XSC-D & XSC-DF
Threads	Metric M5
	BSPP with OR
Working pressure	Up to 10 Bar
Working temperature	Up to 120°C
Tubes used	Polyamide (PA)
	Polyurethane (PU)
	Polyethylene (PE)
	Calibrated teflon PTFE
	Fluoropolymer FEP 140
	Stainless steel tube when grooved with pre-grooving tool SX01UT
Products in conformity with the directive 2002/95/EC RoHS	

Curva de caudal (latón) - Flow charts (brass)

- IMOTSC 0401 IMOTSC-D 0401
- IMOTSC 0601 IMOTSC-D 0601
- IMOTSC 0801 IMOTSC-D 0801

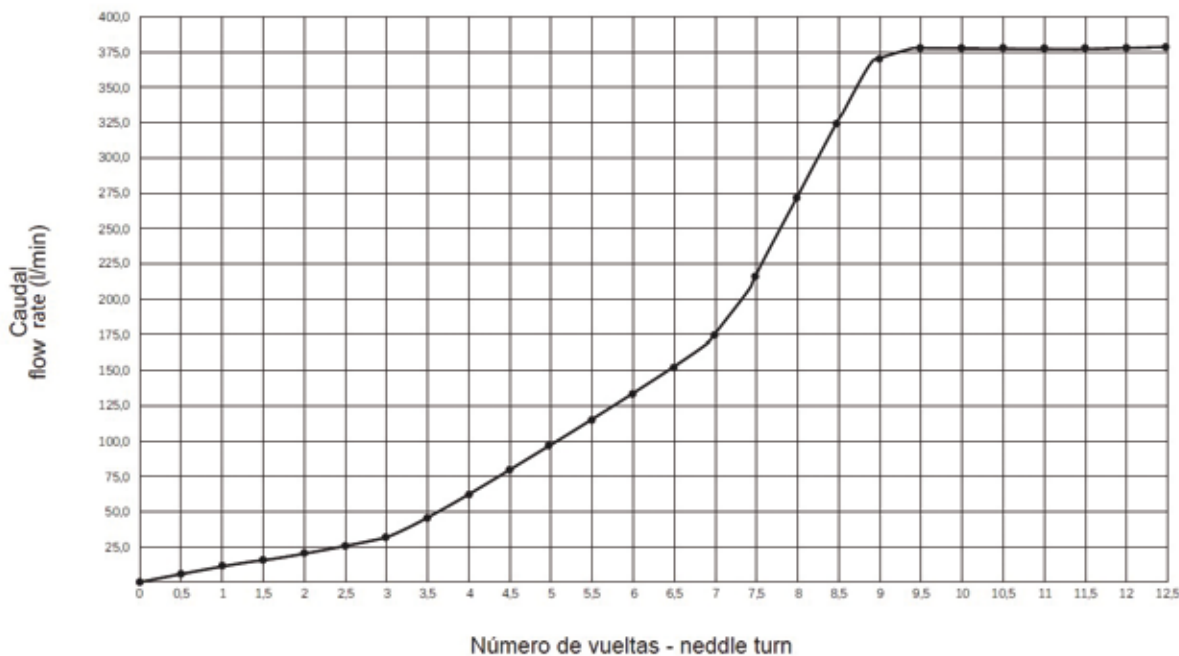

- IMOTSC 0602 IMOTSC-D 0602
- IMOTSC 0802 IMOTSC-D 0802
- IMOTSC 1002 IMOTSC-D 1002

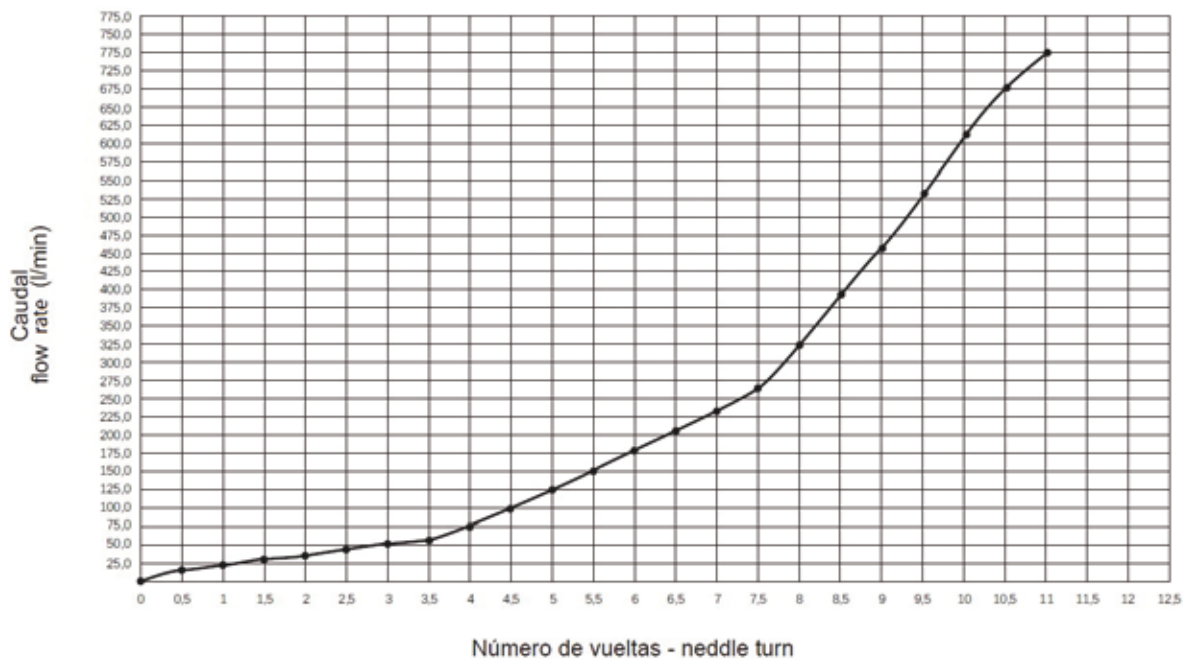

Para otros materiales consultar con el departamento técnico.

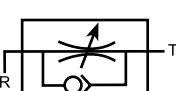

Los datos técnicos y gráficos no son vinculantes. - Drawing and technical date are not binding.

Regulador de caudal tipo banjo, rosca macho cónica BSPT para cilindro y regulación manual en termoplástico
 Banjo male elbow flow regulator BSPT thread for cylinders nickel plated with handle regulation in thermoplastic

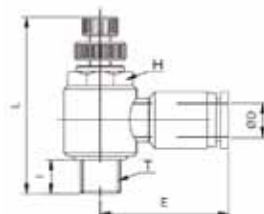
IMONSE	REFERENCIA	ØD	T	L(Max)	I	E	H (Hex)	Peso Weight(g)
 Para cilindro C - For cylinders 	IMONSE0401	4	R1/8"	39,7	7,0	22,3	10	18,0
	IMONSE0402		R1/4"	46,4	9,5	24,1	14	35,9
	IMONSE0601	6	R1/8"	39,7	7,0	23,1	10	18,5
	IMONSE0602		R1/4"	46,4	9,5	25,1	14	36,5
	IMONSE0603		R3/8"	53,4	10,5	26,8	19	60,5
	IMONSE0604		R1/2"	57,9	13,5	29,8	24	92,7
	IMONSE0801	8	R1/8"	39,7	7,0	25,6	10	19,3
	IMONSE0802		R1/4"	46,4	9,5	28,6	14	37,3
	IMONSE0803		R3/8"	53,4	10,5	29,6	19	61,1
	IMONSE0804		R1/2"	57,9	13,5	32,6	24	93,4
	IMONSE1001	10	R1/8"	39,7	7,0	28,8	10	22,7
	IMONSE1002		R1/4"	46,4	9,5	31,0	14	40,7
IMONSE1003	R3/8"		53,4	10,5	31,6	19	64,5	
IMONSE1004	R1/2"		57,9	13,5	34,6	24	96,8	
IMONSE1202	12	R1/4"	46,4	9,5	33,5	14	42,2	
IMONSE1203		R3/8"	53,4	10,5	35,6	19	66,1	
IMONSE1204		R1/2"	57,9	13,5	36,6	24	98,3	



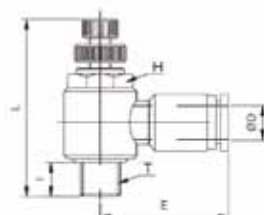

Regulador de caudal tipo banjo, rosca macho cilíndrica BSPP y métrica para cilindro y regulación manual en termoplástico
 Banjo male elbow flow regulator BSPP & metric thread for cylinders nickel plated with handle regulation in thermoplastic

IMONSE-G	REFERENCIA	ØD	T	L(Max)	I	E	H (Hex)	Peso Weight(g)
 Para cilindro C - For cylinders 	IMONSE04M5	4	M5x0,8	29,3	4,0	20,0	8	8,65
	IMONSE04-G01		G1/8"	39,7	5,8	22,3	10	18,0
	IMONSE04-G02		G1/4"	46,4	7,3	24,1	14	35,9
	IMONSE06M5	6	M5x0,8	29,3	4,0	21,9	8	9,3
	IMONSE06-G01		G1/8"	39,7	5,8	23,1	10	18,5
	IMONSE06-G02		G1/4"	46,4	7,3	25,1	14	36,5
	IMONSE06-G03		G3/8"	53,4	8,5	26,8	19	60,5
	IMONSE06-G04	G1/2"	57,9	10,0	29,8	24	92,7	
	IMONSE08-G01	8	G1/8"	39,7	5,8	25,6	10	19,3
	IMONSE08-G02		G1/4"	46,4	7,3	28,6	14	37,3
	IMONSE08-G03		G3/8"	53,4	8,5	29,6	19	61,1
	IMONSE08-G04		G1/2"	57,9	10,0	32,6	24	93,4
IMONSE10-G01	10	G1/8"	39,7	5,8	28,8	10	22,7	
IMONSE10-G02		G1/4"	46,4	7,3	31,1	14	40,7	
IMONSE10-G03		G3/8"	53,4	8,5	31,6	19	64,5	
IMONSE10-G04		G1/2"	57,9	10,0	34,6	24	96,8	
IMONSE12-G02	12	G1/4"	46,4	7,3	33,5	14	42,2	
IMONSE12-G03		G3/8"	53,4	8,5	35,6	19	66,1	
IMONSE12-G04		G1/2"	57,9	10,0	36,6	24	98,3	



Regulador de caudal tipo banjo, rosca cilíndrica BSPP y métrica para válvula y regulación manual en termoplástico
 Banjo male elbow flow regulator BSPP & metric thread for valves nickel plated with handle regulation in thermoplastic

IMONSV-G	REFERENCIA	ØD	T	L(Max)	I	E	H (Hex)	Peso Weight(g)
 Para válvula V - For valves 	IMONSV04M5	4	M5x0,8	29,3	4,0	20,0	8	8,65
	IMONSV04-G01		G1/8"	39,7	5,8	22,3	10	18,0
	IMONSV04-G02		G1/4"	46,4	7,3	24,1	14	35,9
	IMONSV06M5	6	M5x0,8	29,3	4,0	21,9	8	9,3
	IMONSV06-G01		G1/8"	39,7	5,8	23,1	10	18,5
	IMONSV06-G02		G1/4"	46,4	7,3	25,1	14	36,5
	IMONSV06-G03		G3/8"	53,4	8,5	26,8	19	60,5
	IMONSV06-G04	G1/2"	57,9	10,0	29,8	24	92,7	
	IMONSV08-G01	8	G1/8"	39,7	5,8	25,6	10	19,3
	IMONSV08-G02		G1/4"	46,4	7,3	28,6	14	37,3
	IMONSV08-G03		G3/8"	53,4	8,5	29,6	19	61,1
	IMONSV08-G04		G1/2"	57,9	10,0	32,6	24	93,4
IMONSV10-G01	10	G1/8"	39,7	5,8	28,8	10	22,7	
IMONSV10-G02		G1/4"	46,4	7,3	31,1	14	40,7	
IMONSV10-G03		G3/8"	53,4	8,5	31,6	19	64,5	
IMONSV10-G04		G1/2"	57,9	10,0	34,6	24	96,8	
IMONSV12-G02	12	G1/4"	46,4	7,3	33,5	14	42,2	
IMONSV12-G03		G3/8"	53,4	8,5	35,6	19	66,1	
IMONSV12-G04		G1/2"	57,9	10,0	36,6	24	98,3	

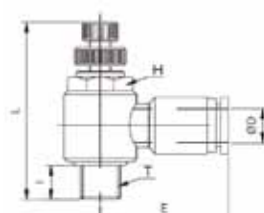

Regulador de caudal orientable rosca macho cilíndrica BSPP para cilindro en latón • Manual swivel flow regulator BSPP thread for cylinders in brass

IMOTSC-C	REFERENCIA	ØD	T	I	L	C	H (Hex)	Peso Weight(g)
	IMOTSC-C0401	4	G1/8"	5,5	43,0	21,1	9	27,0
	IMOTSC-C04M5		M5	4	39,0	18,0	6	13,0
	IMOTSC-C0601	6	G1/8"	5,5	43,0	24,3	9	28,0
	IMOTSC-C0602		G1/4"	6,5	50,0	25,5	12	52,0
	IMOTSC-C0801	8	G1/8"	5,5	43,0	24,8	9	29,0
	IMOTSC-C0802		G1/4"	6,5	50,0	26,5	12	52,0
	IMOTSC-C0803		G3/8"	9	63,0	26,0	14	99,0
IMOTSC-C1002	10	G1/4"	6,5	50,0	28,4	12	59,0	
IMOTSC-C1003		G3/8"	9	63,0	28,0	14	105,0	

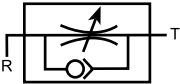
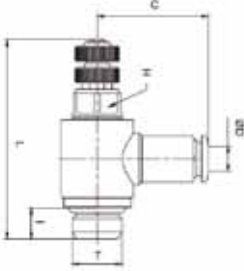

Para cilindro - For cylinders

Regulador de caudal orientable rosca macho cilíndrica BSPP para cilindro con regulación por tornillo en latón
Screwdriver flow regulator BSPP thread for cylinders in brass

IMOTSC-DC	REFERENCIA	ØD	T	I	L	C	H (Hex)	Peso Weight(g)
	IMOTSC-DC04M5	4	M5x0,8	4,0	22,5	17,0	8	12,0
	IMOTSC-DC0401		G1/8"	5,5	34,0	21,1	14	34,0
	IMOTSC-DC0601	6	G1/8"	5,5	34,0	24,3	14	36,0
	IMOTSC-DC0602		G1/4"	6,5	42,0	25,5	17	66,0
	IMOTSC-DC0801	8	G1/8"	5,5	34,0	24,8	14	35,0
	IMOTSC-DC0802		G1/4"	6,5	42,0	26,5	17	66,0
	IMOTSC-DC0803		G3/8"	7,5	46,5	28,0	20	72,0
IMOTSC-DC1002	10	G1/4"	6,5	42,0	28,4	17	84,0	
IMOTSC-DC1003		G3/8"	7,5	46,5	29,9	20	90,0	

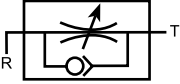

Para cilindro - For cylinders

Regulador de caudal rosca hembra cilíndrica BSPP para cilindro con regulación por tornillo en latón
Screwdriver female flow regulator BSPP thread for cylinders in brass

IMOTSC-DFC	REFERENCIA	T1	T2	L	C	I1	I2	H (Hex)	Peso Weight(g)
	IMOTSC-DFC01	G1/8"	G1/8"	34	20	5,5	7	14	35
	IMOTSC-DFC02	G1/4"	G1/4"	34	24	6,5	8	17	67
	IMOTSC-DFC03	G3/8"	G3/8"	46	28	6,7	10	20	96
	IMOTSC-DFC04	G1/2"	G1/2"	52	35	9,6	11	25	172

Para cilindro - For cylinders

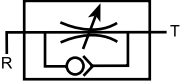
Regulador de caudal rosca macho cilíndrica BSPP para cilindro con regulación por tornillo en AISI 316
 Screwdriver flow regulator BSPP thread for cylinders in AISI 316

IMOXSC-D	REFERENCIA	ØD	T	B	C	D	E	H (Hex)	Peso Weight(g)
	IMOXSC06G01-D	6	G1/8"	6	38	24	8	14,3	16
	IMOXSC06G02-D		G1/4"	8	40	28	12	17,4	19
	IMOXSC08G02-D	8	G1/8"	6	38	24	18	14,3	16
	IMOXSC08G02-D		G1/4"	8	40	28	12	17,4	19
IMOXSC10G02-D	10	G1/4"	8	40	28	12	17,4	19	

Para cilindro - For cylinders

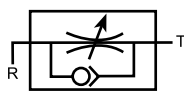
AISI 316

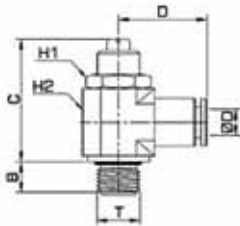
 Regulador de caudal rosca hembra cilíndrica BSPP y métrica para cilindro con regulación por tornillo en AISI 316
 Screwdriver female flow regulator BSPP & metric thread for cylinders in AISI 316

IMOXSC-DF	REFERENCIA	ØD	T	B	C	D	E	H1 (Hex)	H2 (Hex)
	IMOXSC01-DF	G1/8"	6	38	21	8	14,3	19	16
	IMOXSC02-DF	G1/4"	8	40	25	12	17,4	19	19
	IMOXSC03-DF	G3/8"	8	53	28	12	20,6	22	22
	IMOXSC04-DF	G1/2"	10	69	31	15	24,0	28	28

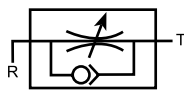
Para cilindro - For cylinders

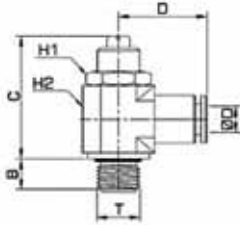
AISI 316

NUEVO

Designación Referencia - Model designation

PVSC
PVSC
Código
Code

06
06
Diámetro Tubo/Rosca
Tube diameter/thread

R01
G01
Rosca
Thread size

Código	Tubo
06	6mm
08	8mm
10	10mm
12	12mm
12	12mm

Cónica BSPT BSPT thread	
R01	R1/8"
R02	R1/4"
R03	R3/8"
R04	R1/2"

Cilíndrica BSPP BSPP thread	
G01	G1/8"
G02	G1/4"
G03	G3/8"
G04	G1/2"

Tratamiento: niquelado
Plating: nickel

Color de la anilla: azul
Sleeve colour: blue

Ejemplo de aplicación - Applied example

Montado en pares bloquea el cilindro cortando simultáneamente el suministro y el escape.
Protege la caída del vástago del cilindro en el estado de apagado de suministro y en el escape.

Mounted in pairs lock the cylinder by simultaneously cutting off the supply and the exhaust
Protect falling down of the rod cylinder in the off state supply and the exhaust

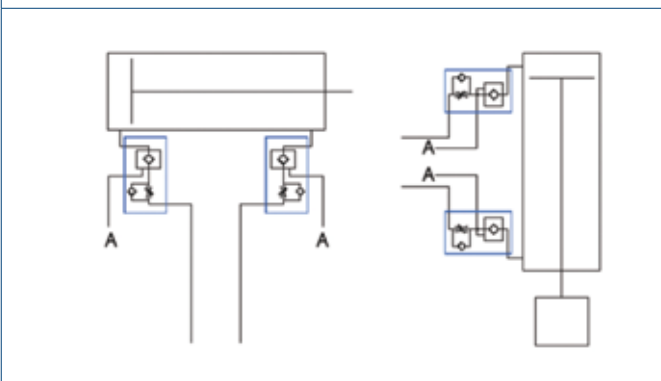

Sección interna - Construction

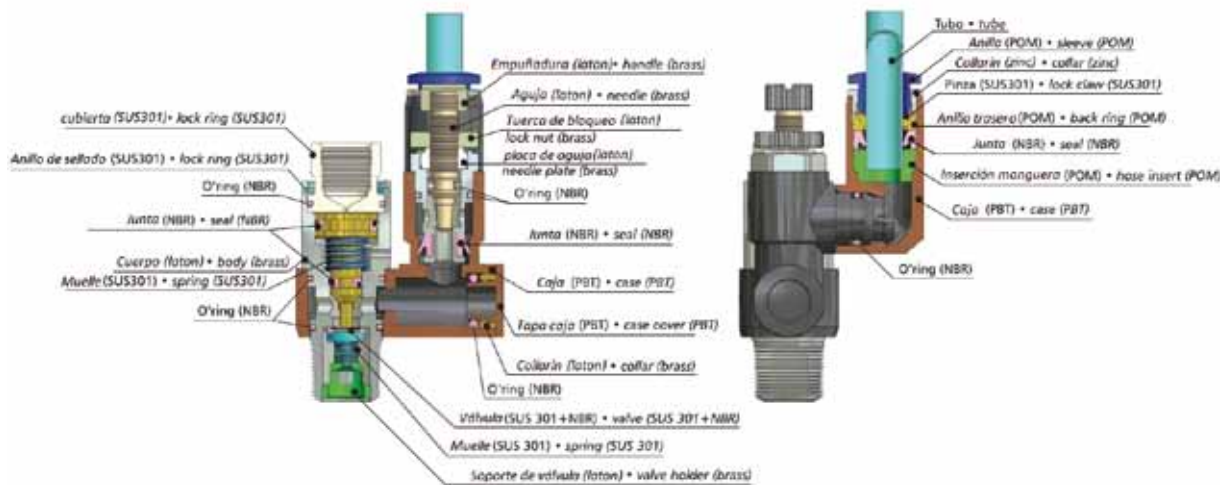

Datos Técnicos

Fluidos compatibles	Aire comprimido
Materiales utilizados	Cuerpo: PBT
	Pinza de agarre: acero SUS 301
	Junta: NBR sin silicona
Tipo de regulación	Manual
Rosca	Gas Cónica BSPT de R1/8" a R1/2" petreflonada
	Gas Cilíndrica BSPP con OR de G1/8" a G1/2"
Presión de trabajo	De 0 a 10 Bar
Tubos utilizados	Poliamida (PA)
	Poliuretano (PU)
Producto conforme a la directiva 2002/95/EC	
Producto conforme a la directiva 1907/2006	

Technical specifications

Fluids types	Compressed air
Materials Used	Body: PBT
	Lock claw: steel SUS 301
	O'ring: NBR silicon free
Type of regulation	Manual
Threads	BSPT from R1/8" to R1/2" teflon coated
	BSPP with from G1/8" to G1/2"
Working pressure	From 0 to 10 bar
Tubes used	Polyamide (PA)
	Polyurethane (PU)
Products in conformity with the directive 2002/95/EC	
Products in conformity with the directive 1907/2006	

Diagramas de flujo - Flow charts

<p>PVSC 06-01 PVSC 08-01</p> <p>Control de flujo <i>flow control</i></p>	<p>Flujo libre <i>free flow</i></p>
<p>PVSC 06-02 PVSC 08-02</p> <p>Control de flujo <i>flow control</i></p>	<p>Flujo libre <i>free flow</i></p>
<p>PVSC 08-03 PVSC 10-03 PVSC 12-03</p> <p>Control de flujo <i>flow control</i></p>	<p>Flujo libre <i>free flow</i></p>
<p>PVSC 10-04 PVSC 12-04</p> <p>Control de flujo <i>flow control</i></p>	<p>Flujo libre <i>free flow</i></p>

PVSC

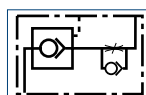
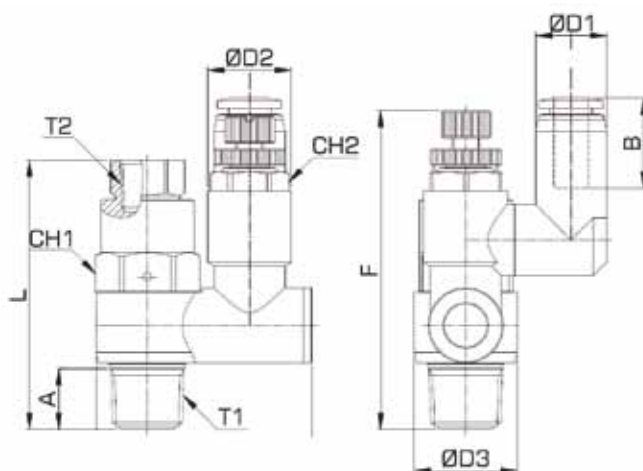

REFERENCIA	ØD	T1	T2	A	B	ØD1	ØD2	ØD3	L	F (min)	F (max)	H1 (Hex)	H2 (Hex)	Peso Weight(g)
PVSC06R01	6	R1/8"	M5	8,5	16,4	12,5	12,0	14,2	41,0	50,6	55,4	12	10	39,6
PVSC06R02		R1/4"	R1/8"	11,1	16,4	13,0	15,3	18,8	49,1	57,1	61,9	17	13	71,4
PVSC08R01	8	R1/8"	M5	8,5	18,3	14,8	12,0	14,2	41,0	50,6	55,4	12	10	41,6
PVSC08R02		R1/4"	R1/8"	11,1	18,3	14,8	15,3	18,8	49,1	57,1	61,9	17	13	76,4
PVSC08R03		R3/8"	R1/8"	11,9	18,3	15,0	20,2	23,0	56,9	67,2	72,2	19	17	128,9
PVSC10R03	10	R3/8"	R1/8"	11,9	20,2	17,5	20,2	23,0	56,9	67,2	72,2	19	17	130,9
PVSC10R04		R1/2"	R1/4"	14,9	20,2	17,5	27,2	28,7	70,8	81,3	87,0	24	23	244,6
PVSC12R03	12	R3/8"	R1/8"	11,9	22,9	20,5	20,2	23,0	56,9	67,2	72,2	19	17	138,9
PVSC12R04		R1/2"	R1/4"	14,9	22,9	20,5	27,2	28,7	70,8	81,3	87,0	24	23	234,6

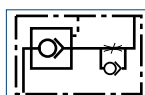
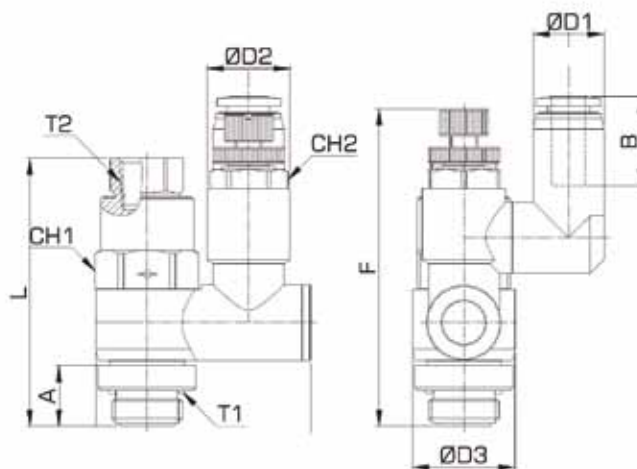
PVSC-G

REFERENCIA	ØD	T1	T2	A	B	ØD1	ØD2	ØD3	L	F (min)	F (max)	H1 (Hex)	H2 (Hex)	Peso Weight(g)
PVSC06G01	6	R1/8"	M5	5,1	16,4	12,5	12,0	14,2	41,0	50,6	55,4	12	10	44,6
PVSC06G02		R1/4"	R1/8"	6,6	16,4	13,0	15,3	18,8	49,1	57,1	61,9	17	13	79,4
PVSC08G01	8	R1/8"	M5	5,1	18,3	14,8	12,0	14,2	41,0	50,6	55,4	12	10	42,6
PVSC08G02		R1/4"	R1/8"	6,6	18,3	14,8	15,3	18,8	49,1	57,1	61,9	17	13	80,4
PVSC08G03		R3/8"	R1/8"	7,2	18,3	15,0	20,2	23,0	56,9	67,2	72,2	19	17	124,9
PVSC10G03	10	R3/8"	R1/8"	7,2	20,2	17,5	20,2	23,0	56,9	67,2	72,2	19	17	137,9
PVSC10G04		R1/2"	R1/4"	8,7	20,2	17,5	27,2	28,7	70,8	81,3	87,0	24	23	252,6
PVSC12G03	12	R3/8"	R1/8"	7,2	22,9	20,5	20,2	23,0	56,9	67,2	72,2	19	17	145,9
PVSC12G04		R1/2"	R1/4"	8,7	22,9	20,5	27,2	28,7	70,8	81,3	87,0	24	23	238,6

Designación de la referencia - Model designation

IMONSF
XSF
IMOASF

Código
Code

U
U

Tipo
Type

01
04
01

Diámetro Tubo/Rosca
Tube diameter/thread

Materiales Utilizados
Materials Used

IMONSF: Termoplástico PBT
XSF: INOX AISI 316
IMOASF: Aluminio - aluminium

U: Unidireccional
U: Unidirectional

B: Bidireccional
B: Bidirectional

Código	Tubo
04	4mm
06	6mm
08	8mm
10	10mm
12	12mm



Rosca BSPP BSPP thread	
01	G1/8"
02	G1/4"
03	G3/8"
04	G1/2"

REGULADORES DE CAUDAL EN LÍNEA DE TERMOPLÁSTICO PLASTIC FLAT FLOW REGULATORS

Datos Técnicos	
Aplicaciones	Neumática
Materiales utilizados	Termoplástico PBT
Tipo de Regulación	Manual con contratuerca para fijación
Presión de trabajo	de 0 a 10 Bar / de 0 a 150 PSI
Presión de vacío	-750mmHG (-750 torr)
Temperatura de trabajo	de 0°C a 60°C
Tubos utilizados	Poliamida (PA)
	Poliuretano (PU)
	Poliétileno (PE)
Producto conforme a la directiva 2002/95/EC RoHS	

Technical specifications	
Applications	Pneumatics
Materials Used	PBT
Type of regulation	Manual
Working pressure	From 0 to 150 psi / from 1 to 10 Bar
Negative pressure	-750mmHG (-750 torr)
Working temperatura	From 0°C to 60°C
Tubes used	Polyamide (PA)
	Polyurethane (PU)
	Polyethylene (PE)
Products in conformity with the directive 2002/95/EC RoHS	

Los datos técnicos y gráficos no son vinculantes. - Drawing and technical date are not binding.

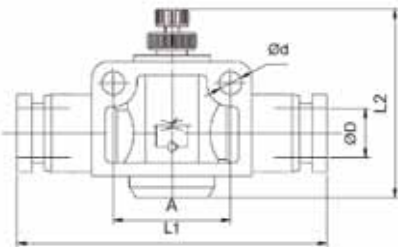
Regulador de caudal en línea • Flat flow regulator							
IMONSF	REFERENCIA	ØD	Ød	A	L1	L2	Peso Weight(g)
	IMONSF04	4	3,2	14	39,5	28,8	11,7
	IMONSF06	6	4,3	20	47,6	42,6	27,0
	IMONSF08	8	4,3	22	52,6	44,3	39,5
	IMONSF10	10	4,3	26	60,5	53,4	69,0
	IMONSF12	12	4,3	32	74,2	55,6	113,2
Unidireccional - Unidirectional 							

REGULADORES DE CAUDAL EN LÍNEA EN ALUMINIO ALUMINIUM FLAT FLOW REGULATORS

Datos Técnicos	
Aplicaciones	IMOASF: neumática
	IMOASF-B: neumática y fluidos
Materiales utilizados	Cuerpo: aluminio 11S anodizado negro
	Tuerca de regulación: latón niquelado
	Juntas tóricas: NBR
Tipo de regulación	Manual con contratuerca de fijación
Rosca	BSPP hembra cilíndrica
Presión de trabajo	0,5 - 10 Bar
Temperatura de trabajo	de 0°C a 65°C
Producto conforme a la directiva 2002/95/EC RoHS	



Technical specifications	
Applications	IMOASF: pneumatics
	IMOASF-B: pneumatics & fluids
Materials Used	Body: aluminium 11S with black anodization
	Regulation screw: nickel plated brass
	Seals: NBR
Type of regulation	manual
Threads	female BSPP thread
Working pressure	0,5 - 10 Bar
Working temperature	from 0°C to 65°C
Products in conformity with the directive 2002/95/EC RoHS	

Los datos técnicos y gráficos no son vinculantes. - Drawing and technical date are not binding.

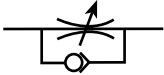
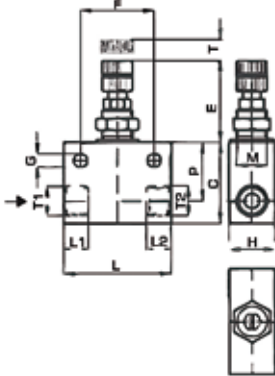
Regulador de caudal en línea unidireccional con rosca BSPP cilíndrica en aluminio • Unidirectional female flow regulator BSPP thread in aluminium

IMOASF-U	REFERENCIA	T1	T2	L	L1	L2	C	H (Hex)	M	F	G	E	P	T	Peso Weight (g)
 Unidireccional - Unidirectional 	IMOASF-01	G1/8"	G1/8"	35	8,0	8,0	27	15	10x1	24	4,5	26	19,5	7,0	52,0
	IMOASF-02	G1/4"	G1/4"	40	9,5	9,5	30	18	10x1	24	4,5	26	21,0	7,0	90,0
	IMOASF-03	G3/8"	G3/8"	45	10,5	10,5	35	22	15x1	30	6,0	31	25,0	8,5	206,0
	IMOASF-04	G1/2"	G1/2"	57	12,0	12,0	40	27	15x1	30	6,0	31	26,0	8,5	217,0
															

Regulador de caudal en línea bidireccional con rosca hembra cilíndrica BSPP en aluminio • Bidirectional female flow regulator BSPP thread in aluminium

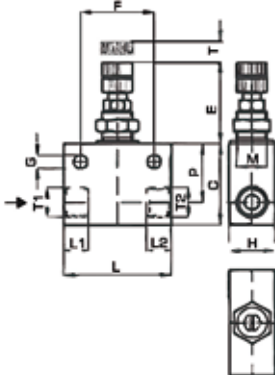
IMOASF-B	REFERENCIA	T1	T2	L	L1	L2	C	H (Hex)	M	F	G	E	P	T	Peso Weight (g)
 Bidireccional - bidirectional 	IMOASF-B01	G1/8"	G1/8"	35	8,0	8,0	27	15	10x1	24	4,5	26	19,5	7,0	52,0
	IMOASF-B02	G1/4"	G1/4"	40	9,5	9,5	30	18	10x1	24	4,5	26	21,0	7,0	90,0
	IMOASF-B03	G3/8"	G3/8"	45	10,5	10,5	35	22	15x1	30	6,0	31	25,0	8,5	206,0
	IMOASF-B04	G1/2"	G1/2"	57	12,0	12,0	40	27	15x1	30	6,0	31	26,0	8,5	217,0
															

REGULADORES DE CAUDAL EN LÍNEA INOX AISI 316
FLAT FLOW REGULATORS INOX AISI 316

Datos Técnicos	
Aplicaciones	Sector alimentario, químico, naval, farmacéutico y aplicaciones en ambientes agresivos
	XSF-U: neumática
	XSF-B: neumática y fluidos
Materiales utilizados	Acero INOX AISI 316L
	Juntas tóricas: FKM / VMQ alimentario
Roscas	Gas cilíndrica ISO 228
	NPT
Presión de trabajo	1-16 Bar para el regulador unidireccional XSF-U
	0-40 Bar para el regulador bidireccional XSF-B
Temperatura de trabajo	-15°C +160°C
Producto conforme a la directiva 2002/95/EC RoHS	

Technical specifications	
Applications	Food, chemical, nautical, medical, pharmaceutical & aggressive applications.
	XSF-U: pneumatics
	XSF-B: pneumatics & fluids
Materials Used	Stainless steel AISI 316L
	Seal: food FKM / VMQ (FDA)
Threads	cylindrical gas ISO 228
	NPT
Working pressure	1-16 Bar for unidirectional flow regulators XSF-U
	0-40 Bar for bidirectional flow regulators XSF-B
Working temperature	-15°C +160°C
Products in conformity with the directive 2002/95/EC RoHS	

Los datos técnicos y gráficos no son vinculantes. - Drawing and technical data are not binding.

Regulador de caudal rosca hembra cilíndrica BSPP INOX AISI 316 L • Unidirectional female flow regulator BSPP thread INOX AISI 316 L

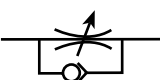
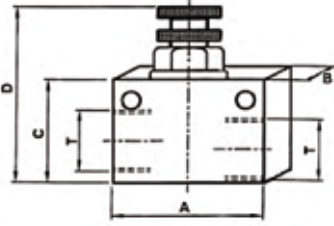
XSF-U  Unidireccional - Unidirectional 	REFERENCIA	T	A	B	C	D max	D min	Caudal máx. Max capacity l/min	Peso Weight(g)
	XSF-U01	G1/8"	39,8	19,7	30,0	53,5	47,1	800	172,0
	XSF-U02	G1/4"	39,8	19,7	30,0	53,5	47,1	800	161,0
	XSF-U03	G3/8"	47,6	24,8	35,1	65,6	56,3	1650	260,0
	XSF-U04	G1/2"	47,6	24,8	35,1	65,6	56,3	1950	281,0
 AISI 316									

Regulador de caudal en línea unidireccional rosca NPT INOX AISI 316 L • Unidirectional female flow regulator NPT thread INOX AISI 316 L

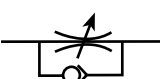
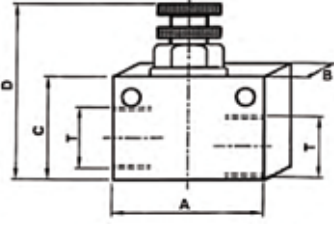
XSF-U-NPT  Unidireccional - Unidirectional 	REFERENCIA	T	A	B	C	D max	D min	Caudal máx. Max capacity l/min	Peso Weight(g)	
	XSF-U04NPT	N1/2"	47,6	24,8	35,1	65,6	56,3	1950	260,0	
	 AISI 316									

Regulador de caudal bidireccional rosca hembra NPT INOX AISI 316 L • Bidirectional female flow regulator NPT thread INOX AISI 316 L

XSF-B	REFERENCIA	T	A	B	C	D		Caudal máx. Max capacity l/min	Peso Weight(g)
						max	min		
	XSF-B01	G1/8"	39,8	19,7	30,0	53,5	47,8	800	173,0
	XSF-B02	G1/4"	39,8	19,7	30,0	53,5	47,8	800	162,0
	XSF-B03	G3/8"	47,6	24,8	35,1	65,6	59,1	1650	263,0
	XSF-B04	G1/2"	47,6	24,8	35,1	65,6	59,1	1950	287,0

Bidireccional - Bidirectional



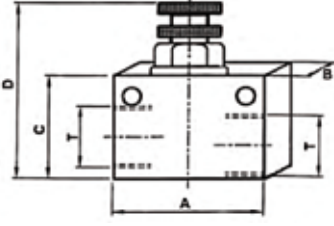

AISI 316

Regulador de caudal bidireccional rosca hembra cilíndrica BSPP INOX AISI 316 L • Bidirectional female flow regulator BSPP thread INOX AISI 316 L

XSF-B-NPT	REFERENCIA	T	A	B	C	D		Caudal máx. Max capacity l/min	Peso Weight(g)
						max	min		
	XSF-B04NPT	N1/2"	47,6	24,8	35,1	65,6	59,1	1950	263,0

Bidireccional - Bidirectional



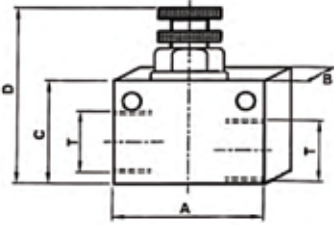

AISI 316

Datos Técnicos	
Aplicaciones	Circuitos neumáticos
Materiales utilizados	Cuerpo/tapa: latón UNI EN 12165 CW 617N
	Membrana: elastómero poliuretánico
	Arandela de sujeción: nylon
Tratamiento superficial	Niquelado
Roscas	Gas cilíndrica ISO 228
Presión de trabajo	de 0,3 Bar a 10 Bar
Temperatura de trabajo	de -18°C a +70°C
Producto conforme a la directiva 2002/95/EC RoHS	

Technical specifications	
Applications	Pneumatic systems
Materials Used	Body/cap: brass UNI EN 12165 CW 617N
	Membrane: polyurethane elastomer
	Body/cap seal: nylon
Surface treatment	Nickel plating
Threads	Cylindrical gas ISO 228
Working pressure	From 0,3 bar to 10 bar
Working temperature	From -18°C to +70°C
Products in conformity with the directive 2002/95/EC RoHS	

Los datos técnicos y gráficos no son vinculantes. - Drawing and technical data are not binding.

Válvula de escape rápido • Quick exhaust valve									
IMO-VES	REFERENCIA	T	I	L1	L2	L3	H1 (Hex)	H2 (Hex)	Peso Weight(g)
	IMO-VES-M5	M5	4,0	24,8	15,6	10,5	10	10	27,0
	IMO-VES-18	G1/8"	8,0	42,0	28,0	19,5	14	14	84,0
	IMO-VES-14	G1/4"	11,0	53,0	34,5	25,0	19	19	146,0
	IMO-VES-38	G3/8"	12,0	58,0	36,0	26,0	21	21	150,0
	IMO-VES-12	G1/2"	14,0	71,0	44,0	35,0	26	26	314,0
	IMO-VES-34	G3/4"	18,0	86,0	52,0	38,5	32	32	450,0
	IMO-VES-01	G1"	19,0	94,0	56,0	42,0	38	38	525,0

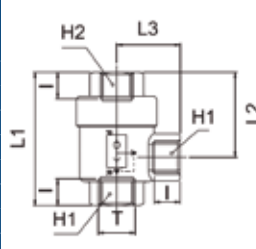

Arandela de sujeción • Body/cap seal in nylon						
AVES	REFERENCIA	-	A	B	C	Peso Weight(g)
	AVES-M5	M5	17,0	12,4	0,8	0,08
	AVES-18	1/8"	23,8	20,0	1,0	0,014
	AVES-14	1/4"	28,5	24,0	1,0	0,018
	AVES-38	3/8"	28,5	24,0	1,0	0,018
	AVES-12	1/2"	38,6	32,0	1,5	0,03
	AVES-34	3/4"	45,0	38,0	1,5	0,76
	AVES-01	1"	45,0	38,0	1,5	0,76

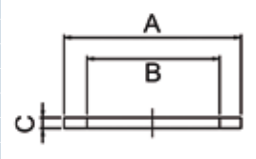

Membrana para válvula en elastómero poliuretánico • Membrane for valve in polyurethane elastomer					
JVES	REFERENCIA	-	A	B	Peso Weight(g)
	JVES-M5	M5	13,5	4,5	0,4
	JVES-18	1/8"	20,5	5,0	1,1
	JVES-14	1/4"	25,5	5,8	1,9
	JVES-38	3/8"	25,5	5,8	1,9
	JVES-12	1/2"	35,5	8,2	2,5
	JVES-34	3/4"	40,5	9,0	7,0
	JVES-01	1"	40,5	9,0	7,0

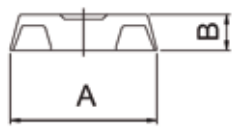

NUEVO

Designación de la referencia - Model designation

HVC HVC	06 06	R01 G01
↓	↓	↓
Código Code	Diámetro Tubo/Rosca Tube diameter/thread	Rosca Thread size

Código	Tubo
06	6mm
08	8mm
10	10mm
12	12mm

Cónica BSPT BSPT thread	
R01	R1/8"
R02	R1/4"
R03	R3/8"
R04	R1/2"

Cilíndrica BSPP BSPP thread	
G01	G1/8"
G02	G1/4"
G03	G3/8"
G04	G1/2"

Ejemplo de aplicación - Applied example

Mini válvulas de 3/2 vías bloquean la entrada de aire en el estado de apagado y descargan la presión restante.

3/2 ways mini valves discharge the remaining pressure out and block the incoming air in the off state.

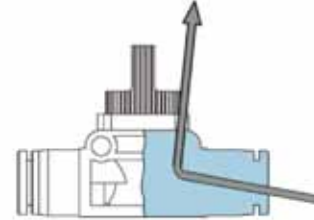

Sección interna - Construction

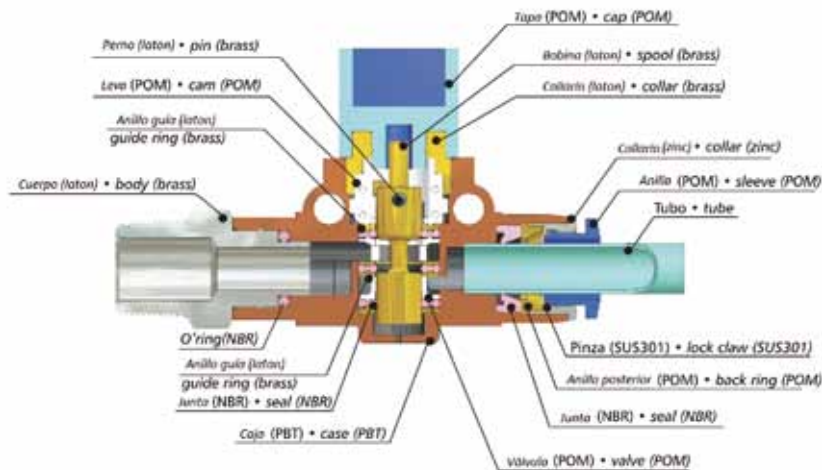

Datos Técnicos

Fluidos compatibles	Aire comprimido
Materiales utilizados	Cuerpo: Latón niquelado y PBT
	Pinza de agarre: acero SUS 301
	Juntas: NBR sin silicona
Rosca	Gas Cónica BSPT de R1/8" a R1/2" petreflonada
	Gas Cilíndrica BSPP con OR de G1/8" a G1/2"
Presión de trabajo	de 0 a 10 Bar
Temperatura de trabajo	de 0°C a 60°C
Tubos utilizados	Poliamida (PA)
	Poliuretano (PU)
Producto conforme a la directiva 2002/95/EC	
Producto conforme a la directiva 1907/2006	

Technical specifications

Fluids types	Compressed air
Materials Used	Body: brass nickel plated & PBT
	Lock claw: steel SUS 301
	Seals: NBR silicon free
Threads	BSPT from R1/8" to R1/2" teflon coated
	BSPP with from G1/8" to G1/2"
Working pressure	From 0 to 10 bar
Working temperature	from 0°C to 60°C
Tubes used	Polyamide (PA)
	Polyurethane (PU)
Products in conformity with the directive 2002/95/EC	
Products in conformity with the directive 1907/2006	

HVC

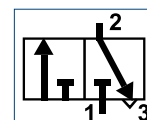
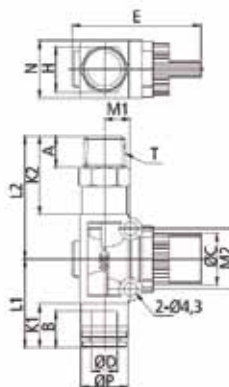

REFERENCIA	ØD	T	ØP	H (Hex)	ØC	N	E	A	B	K1	K2	L1	L2	M1	M2	Peso Weight(g)
HVC06R01	6	R1/8"	12,5	14	16,3	18,0	40,3	8,0	16,4	12,3	21,6	26,3	35,6	8,2	19,0	37,0
HVC06R02		R1/4"		14				10,0			24,6		38,6			37,0
HVC06R03		R3/8"		17				11,0			25,6		39,6			47,0
HVC08R01	8	R1/8"	14,8	14	16,3	18,0	40,3	8,0	18,7	13,9	21,6	27,9	35,6	8,2	19,0	35,0
HVC08R02		R1/4"		14				10,0			24,6		38,6			41,0
HVC08R03		R3/8"		17				11,0			25,6		39,6			48,0
HVC10R02	10	R1/4"	17,5	17	19,3	21,2	40,5	10,0	20,1	14,4	23,0	30,9	39,5	10,9	24,0	58,0
HVC10R03		R3/8"		17				11,0			24,0		40,5			61,0
HVC10R04		R1/2"		21				14,0			27,0		43,5			82,0
HVC12R02	12	R1/4"	20,5	19	19,3	21,2	40,5	10,0	22,8	17,6	24,6	34,1	41,1	10,9	24,0	69,0
HVC12R03		R3/8"		19				11,0			25,6		42,1			68,0
HVC12R04		R1/2"		21				14,0			28,6		45,1			76,0

HVC-G

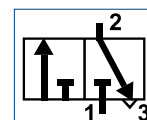
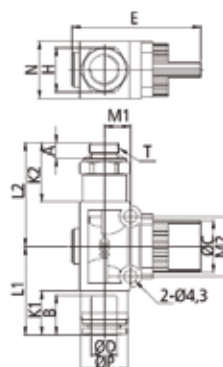

REFERENCIA	ØD	T	ØP	H (Hex)	ØC	N	E	A	B	K1	K2	L1	L2	M1	M2	Peso Weight(g)
HVC06G01	6	R1/8"	12,5	14	16,3	18,0	40,3	5,0	16,4	12,3	18,6	26,3	32,6	8,2	19,0	37,0
HVC06G02		R1/4"		17				6,5			20,6		34,6			37,0
HVC06G03		R3/8"		20				6,5			20,1		34,1			47,0
HVC08G01	8	R1/8"	14,8	14	16,3	18,0	40,3	5,0	18,7	18,6	21,6	27,9	32,6	8,2	19,0	35,0
HVC08G02		R1/4"		17				6,5			20,6		34,6			41,0
HVC08G03		R3/8"		20				6,5			20,1		34,1			48,0
HVC10G02	10	R1/4"	17,5	17	19,3	21,2	40,5	6,5	20,1	19,0	23,0	30,9	35,5	10,9	24,0	58,0
HVC10G03		R3/8"		20				6,5			28,5		35,0			61,0
HVC10G04		R1/2"		24				8,0			20,0		36,5			82,0
HVC12G02	12	R1/4"	20,5	19	19,3	21,2	40,5	6,5	22,8	20,6	24,6	34,1	37,1	10,9	24,0	69,0
HVC12G03		R3/8"		20				6,5			20,1		36,6			68,0
HVC12G04		R1/2"		24				8,0			21,6		38,1			76,0

HVF

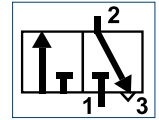
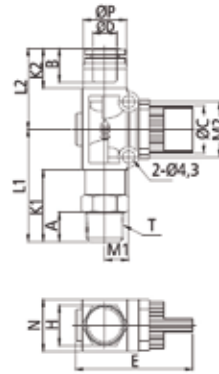

REFERENCIA	ØD	T	ØP	H (Hex)	ØC	N	E	A	B	K1	K2	L1	L2	M1	M2	Peso Weight(g)
HVF06R01	6	R1/8"		14				8,0			21,6		35,6			37,0
HVF06R02	6	R1/4"	12,5	14	16,3	18,0	40,3	10,0	16,4	12,3	24,6	26,3	38,6	8,2	19,0	37,0
HVF06R03	6	R3/8"		17				11,0			25,6		39,6			47,0
HVF08R01	8	R1/8"		14				8,0			21,6		35,6			35,0
HVF08R02	8	R1/4"	14,8	14	16,3	18,0	40,3	10,0	18,7	13,9	24,6	27,9	38,6	8,2	19,0	41,0
HVF08R03	8	R3/8"		17				11,0			25,6		39,6			48,0
HVF10R02	10	R1/4"		17				10,0			23,0		39,5			58,0
HVF10R03	10	R3/8"	17,5	17	19,3	21,2	40,5	11,0	20,1	14,4	24,0	30,9	40,5	10,9	24,0	61,0
HVF10R04	10	R1/2"		21				14,0			27,0		43,5			82,0
HVF12R02	12	R1/4"		19				10,0			24,6		41,1			69,0
HVF12R03	12	R3/8"	20,5	19	19,3	21,2	40,5	11,0	22,8	17,6	25,6	34,1	42,1	10,9	24,0	68,0
HVF12R04	12	R1/2"		21				14,0			28,6		45,1			76,0

HVF-G

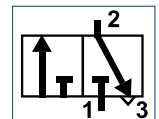
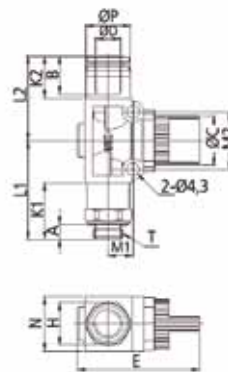

REFERENCIA	ØD	T	ØP	H (Hex)	ØC	N	E	A	B	K1	K2	L1	L2	M1	M2	Peso Weight(g)
HVF06G01	6	R1/8"		14				5,0			18,6		32,6			37,0
HVF06G02	6	R1/4"	12,5	17	16,3	18,0	40,3	6,5	16,4	12,3	20,6	26,3	34,6	8,2	19,0	37,0
HVF06G03	6	R3/8"		20				6,5			20,1		34,1			47,0
HVF08G01	8	R1/8"		14				5,0			21,6		32,6			35,0
HVF08G02	8	R1/4"	14,8	17	16,3	18,0	40,3	6,5	18,7	18,6	20,6	27,9	34,6	8,2	19,0	41,0
HVF08G03	8	R3/8"		20				6,5			20,1		34,1			48,0
HVF10G02	10	R1/4"		17				6,5			23,0		35,5			58,0
HVF10G03	10	R3/8"	17,5	20	19,3	21,2	40,5	6,5	20,1	19,0	28,5	30,9	35,0	10,9	24,0	61,0
HVF10G04	10	R1/2"		24				8,0			20,0		36,5			82,0
HVF12G02	12	R1/4"		19				6,5			24,6		37,1			69,0
HVF12G03	12	R3/8"	20,5	20	19,3	21,2	40,5	6,5	22,8	20,6	20,1	34,1	36,6	10,9	24,0	68,0
HVF12G04	12	R1/2"		24				8,0			21,6		38,1			76,0

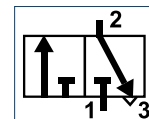
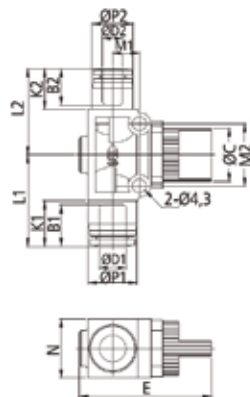
HVU

REFERENCIA	ØD1	ØD2	ØP1	ØP1	ØC	N	E	B1	B2	K1	K2	L1	L2	M1	M2	Peso Weight(g)
HVU0606	6	6	12,5	12,5	16,3	18,0	40,3	16,4	16,4	12,3	12,3	26,3	26,3	8,2	19,0	27,0
HVU0806	8	6	12,5	12,5	16,3	18,0	40,3	16,4	16,4	12,3	12,3	26,3	26,3	8,2	19,0	27,0
HVU0808		8	14,8	14,8	16,3	18,0	40,3	18,7	18,7	13,9	13,9	27,9	27,9	8,2	19,0	28,0
HVU1008	10	8	14,8	14,8	19,3	21,2	40,5	20,1	18,7	14,4	13,9	30,9	27,9	10,9	24,0	41,0
HVU1010		10	17,5	17,5	19,3	21,2	40,5	20,1	20,1	14,4	14,4	30,9	30,9	10,9	24,0	42,0
HVU1210	12	10	17,5	17,5	19,3	21,2	40,5	22,8	20,1	17,6	14,4	34,1	30,9	10,9	24,0	45,0
HVU1212		12	20,5	20,5	19,3	21,2	40,5	22,8	22,8	17,6	17,6	34,1	34,1	10,9	24,0	47,0

NUEVO

Designación Referencia - Model designation

IMOVST	02	08
Código Code	Rosca Thread size	Presión de Tarado Set pressure
	Cilíndrica BSPP BSPP thread	
	02	1/4"
	03	3/8"
	05	3/4"

Componentes - Components

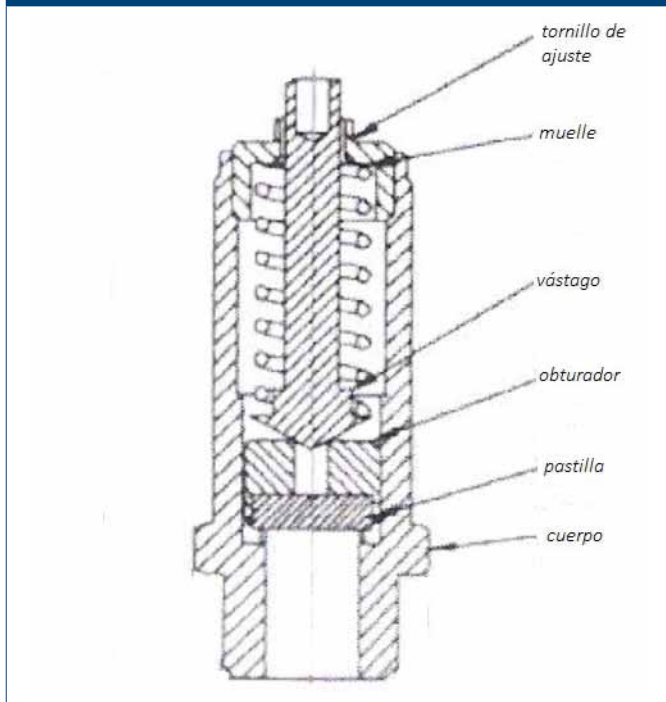

Datos Técnicos

Aplicaciones	Neumática
Materiales utilizados	Cuerpo válvula: latón niquelado EN 12164 CW614N
	Pastilla: NBR
	Obturador: latón niquelado EN 12164 CW614N
	Vástago: acero EN 10203-2-4
	Muelle: acero EN 10270-1-SH
	Tornillo de ajuste: latón niquelado EN 12164 CW614N
Rosca	Gas cilíndrica BSPP 1/4", 3/8" y 3/4"
Temperatura de trabajo	De -10°C a 80°C
Producto conforme a la directiva 97/23/CE	

Technical specifications

Applications	Air compressed
Materials Used	Valve body: brass nickel plated EN 12164 CW614N
	Pad: NBR
	Shutter: brass nickel plated EN 12164 CW614N
	Rod: steel EN 10203-2-4
	Spring: steel EN 10270-1-SH
	Regulation screw: brass nickel plated EN 12164 CW614N
Threads	BSPP threads 1/4", 3/8" and 3/4"
Working temperature	From -10°C to 80°C
Products in conformity with the directive 97/23/CE	

Los datos técnicos y gráficos no son vinculantes. - Drawing and technical date are not binding.

Válvula de seguridad tarada • Safety tares valve

IMOVST	REFERENCIA	ROSCA	PRESIÓN (bar)	CAUDAL (l/min)
	IMOVST02-08	1/4"	8	2001
	IMOVST02-10		10	3585
	IMOVST02-15		15	11841
	IMOVST03-08	3/8"	8	2446
	IMOVST03-10		10	4339
	IMOVST03-15		15	14521
	IMOVST05-08	3/4"	8	3571
	IMOVST05-10		10	6228
	IMOVST05-15		15	21223

NUEVO
Designación Referencia - Model designation

IMOVN **06**
 06
 | |
 Código Diámetro Tubo/Rosca
 Code Tube diameter/thread

Código	Tubo
06	6mm
08	8mm

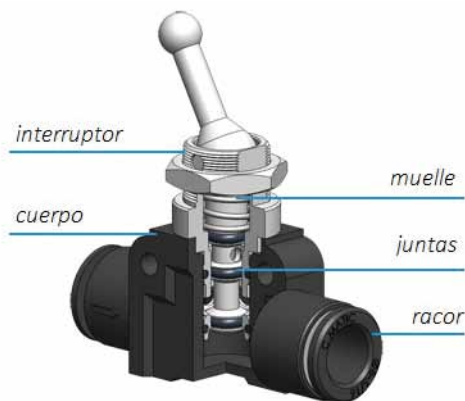
Sección interna - Construction

Datos Técnicos

Aplicaciones	Instalaciones neumáticas alimentarias con aire filtrado y lubricado
Materiales utilizados	Cuerpo: POM
	Interruptor: Latón UNI EN 12164 CW614N Niquelado
	Muelle: Acero inoxidable AISI 302
	Juntas: NBR
Presión de trabajo	Máx. 15 bar
Temperatura de trabajo	De -10°C a 70°C
Tubos utilizados	Poliamida (PA)
	Poliuretano (PU)
Características	Caudal a 6 bar Ø6 400NI/min
	Ø8 500NI/min
Producto conforme a la directiva 97/23/CE	

Technical specifications

Applications	Pneumatic installations fed with filtered and lubricated air
Materials Used	Body: POM
	Pneumatic switch: Brass UNI EN 12164 CW614N Nickel plated
	Spring: Stainless Steel AISI 302
	Seals: NBR
Working pressure	Máx. 15 bar
Working temperature	From -10°C to 70°C
Tubes used	Polyamide (PA)
	Polyurethane (PU)
Advantages	Flow rate at 6 bar Ø6 400NI/min
	Ø8 500NI/min
Products in conformity with the directive 97/23/CE	

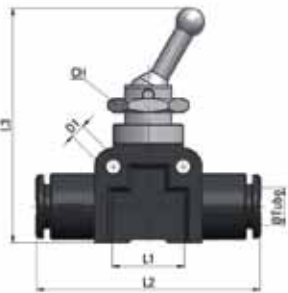
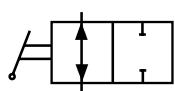
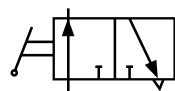
Los datos técnicos y gráficos no son vinculantes. - Drawing and technical date are not binding.

IMOVN	REFERENCIA	ØD	D1	L1	L2	L3	H (Hex)	Peso Weight(g)	
	IMOVN06	6	3,2	15	45	49	15	30	
	IMOVN08	8	3,2	15	46	50	15	31,5	
		 2 VÍAS							
		 3 VÍAS							

Para dos vías añadir al final de la referencia "-2".

Para tres vías añadir al final de la referencia "-3".

NUEVO

Designación de la referencia - Model designation

IMOML	06 08	18 14												
Código Code	Diámetro Tubo Tube diameter	Rosca Thread size												
	<table border="1"> <tr> <th>Código</th> <th>Tubo</th> </tr> <tr> <td>06</td> <td>6mm</td> </tr> <tr> <td>08</td> <td>8mm</td> </tr> </table>	Código	Tubo	06	6mm	08	8mm	<table border="1"> <tr> <th colspan="2">Cilíndrica BSPP BSPP thread</th> </tr> <tr> <td>G01</td> <td>G1/8"</td> </tr> <tr> <td>G02</td> <td>G1/4"</td> </tr> </table>	Cilíndrica BSPP BSPP thread		G01	G1/8"	G02	G1/4"
Código	Tubo													
06	6mm													
08	8mm													
Cilíndrica BSPP BSPP thread														
G01	G1/8"													
G02	G1/4"													

Componentes - Components



Datos Técnicos

Aplicaciones	Instalaciones neumáticas alimentarias con aire filtrado y lubricado
Materiales utilizados	Cuerpo: POM
	Rosca: Latón UNI EN 12164 CW614N Niquelado
	Manómetro: acrilonitrilo butadieno estireno (ABS)
Manómetro	Acrilonitrilo butadieno estireno (ABS)
Presión de trabajo	de 0 a 15 bar
Temperatura de trabajo	de 0°C a 70°C
Tubos utilizados	Poliamida (PA)
	Poliuretano (PU)
Precisión	4
Producto conforme a la directiva 97/23/CE	

Technical specifications

Applications	Pneumatic installations fed with filtered and lubricated air
Materials Used	Body: POM
	Rosca: Brass UNI EN 12164 CW614N Nickel plated
	Pressure gauge: acrylonitrile butadiene styrene (ABS)
Pressure gauge	Acrylonitrile butadiene styrene (ABS)
Working pressure	From 0 to 15 bar
Working temperature	From 0°C to 70°C
Tubes used	Polyamide (PA)
	Polyurethane (PU)
Accuracy	4
Products in conformity with the directive 97/23/CE	

IMOML

REFERENCIA	ØD	D1	D2	D3	L1	L2	L3	L4	H (Hex)	Peso Weight(g)
IMOML06	6	3,2	23	-	15	45	38	-	-	15
IMOML06-G01				G1/8"		52		5	13	21
IMOML06-G02				G1/4"		54		6,5	16	23
IMOML08	8			-		46	39,5	-	-	16
IMOML08-G01				G1/8"		53		5	14	23
IMOML08-G02				G1/4"		55		6,5	16	25

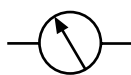

 Versión automática
 Push-in version

 Versión automática con rosca
 Push-in/thread version

Funcionamiento - Operation

Válvula manual para corte y descarga en conducciones de aire comprimido. El movimiento del manguito provoca la apertura de la válvula en un lado y el cierre en el otro lado con la descarga del aire desde ese punto (fig. A)

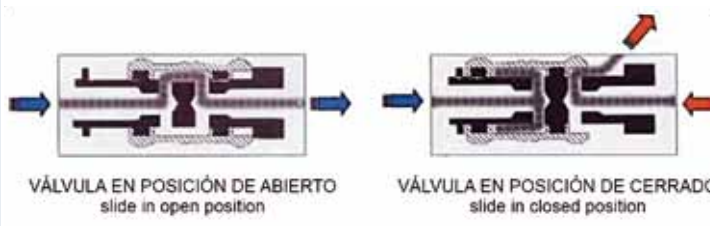
Manual valve for the shut-off and discharge of compressed air hoses. the movement of the slides causes the opening of the valve on one side and its closing on the other with discharge at the downstream conductor



Datos Técnicos

Aplicaciones	Aire comprimido, aire comprimido lubricado, gases variados (excepto gases que puedan ser peligrosos)
Materiales utilizados	Cuerpo: latón CW614N cromado
	Manguito: aluminio anodizado azul
	Junta tórica: NBR 70
	Anillo elástico: acero
Roscas	Gas cilíndrica ISO 228
Dirección del fluido	Indicación de la dirección del fluido marcada sobre el cuerpo
Presión de trabajo	10 Bar
Temperatura de trabajo	de -5°C a +70°C
Producto conforme a la directiva 2002/95/EC RoHS	

Technical specifications

Applications	Compressed air, lubricated compressed air, various gases (except gases which can be dangerous for people and things)
Materials used	Body: brass CW614N chrome plated
	Slider: blue anodized aluminium
	O'ring: NBR 70
	Elastic ring: steel
Threads	Gas BSPP ISO 228
Direction of the flow	Indication of the fluid engraved on the body
Working pressure	10 Bar
Working temperature	From -5°C to +70°C
Products in conformity with the directive 2002/95/EC RoHS	

Los datos técnicos y gráficos no son vinculantes. - Drawing and technical date are not binding.

Válvula de corredera rosca BSPP y métrica • Slide valve BSPP & metric thread

IMO-VC	REFERENCIA	T	D	I	L	H (Hex)	Flujo P-A Flow P-A (Nl/min)	Peso Weight(g)	
	IMO-VC-M5	M5	14	5,0	30,5	10	100	11,0	
	IMO-VC-18	G1/8"	25	9,0	48,0	14	680	51,0	
	IMO-VC-14	G1/4"	30	11,5	58,0	19	1300	98,0	
	IMO-VC-38	G3/8"	35	12,0	70,0	22	2100	156,0	
	IMO-VC-12	G1/2"	40	15,0	75,0	27	3800	212,0	
	IMO-VC-34	G3/4"	50	16,5	83,0	32	5700	317,0	

Funcionamiento - Operation

Válvula de corredera manual para corte y descarga en conducciones de aire comprimido, con descarga en la posición de cerrado. Para abrir o cerrar la válvula, se debe presionar sobre el seguro del manguito y, al mismo tiempo, desplazar el manguito a la posición deseada. "Fig. A"

Slide valve ON/OFF with exhaust in exit in closed position. To open and close the security valve, push with a finger on the point "PRESS" on the cursor (fig. A)

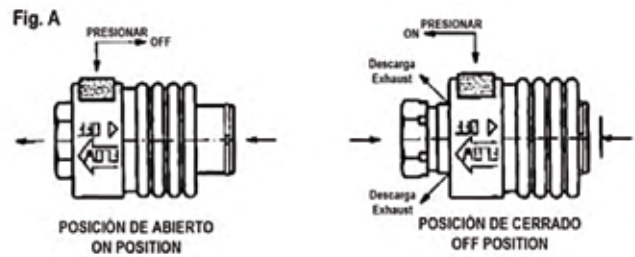

Datos Técnicos

Aplicaciones	Aire comprimido, aire comprimido lubricado y gases excepto aquellos gases que sean peligrosos para las personas o cosas
Materiales utilizados	Perno: cromado
	Manguito: aluminio barnizado en color rojo
	Junta : NBR 70
	Anillo : acero INOX AISI 302
	Cursor: latón cromado
	Muelle: acero INOX AISI 302
Roscas	Gas ISO 228
Dirección del fluido	El indicador de la dirección del fluido marcado sobre el cuerpo.
Seguridad	El sistema de doble bloqueo, está estudiado para evitar que la válvula se cierre o se abra accidentalmente
Presión de trabajo	10 bar
Temperatura de trabajo	De -5°C a +70°C

Technical specifications

Applications	Compressed air, lubricated compressed air, various gases (except gases which can be dangerous for people and things)
Materials used	Pin: brass chrome plated
	Slider: red painted aluminium
	O'ring: NBR 70
	Elastic ring: stainless steel AISI 302
	Cursor: brass chrome plated
	Spring: stainless steel AISI 302
Threads	Gas BSPP ISO 228
Direction of the flow	Indication of the fluid engraved on the body
Security	The double block system avoid the accidental valve opening or closing
Working pressure	10 Bar
Working temperature	From -5°C to +70°C

Products in conformity with the directive 2002/95/EC **RoHS**

Producto conforme a la directiva 2002/95/EC **RoHS**

Los datos técnicos y gráficos no son vinculantes. - Drawing and technical date are not binding.

Válvula de corredera con bloqueo de seguridad rosca hembra cilíndrica BSPP • Slide valve with security block BSPP thread

IMO-VCS	REFERENCIA	T1	T2	L	I1	I2	D	P	H (Hex)
	IMO-VCS-14	G1/4"	G1/4"	46	9,5	9,5	8,0	30	17
	IMO-VCS-38	G3/8"	G3/8"	52	10,5	10,5	10,0	35	21
	IMO-VCS-12	G1/2"	G1/2"	62	12,0	12,0	12,5	40	26

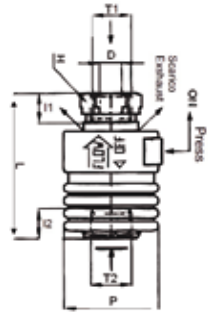

Designación Referencia - Model designation

SPC	06	R01																																								
SPL	04	M5																																								
SPV	06	G01																																								
↓	↓	↓																																								
Código Code	Diámetro Tubo Tube diameter	Rosca Thread size																																								
	<table border="1"> <tr><th>Código</th><th>Tubo</th></tr> <tr><td>04</td><td>4mm</td></tr> <tr><td>06</td><td>6mm</td></tr> <tr><td>08</td><td>8mm</td></tr> <tr><td>10</td><td>10mm</td></tr> <tr><td>12</td><td>12mm</td></tr> <tr><td>14</td><td>14mm</td></tr> </table>	Código	Tubo	04	4mm	06	6mm	08	8mm	10	10mm	12	12mm	14	14mm	<table border="1"> <tr><th colspan="2">Cónica BSPT BSPT thread</th></tr> <tr><td>01</td><td>R1/8"</td></tr> <tr><td>02</td><td>R1/4"</td></tr> <tr><td>03</td><td>R3/8"</td></tr> <tr><td>04</td><td>R1/2"</td></tr> <tr><th colspan="2">Métrica Metric Thread</th></tr> <tr><td>M5</td><td>M5x0,8</td></tr> <tr><td>M6</td><td>M6x1,0</td></tr> <tr><th colspan="2">Cilíndrica BSPP BSPP thread</th></tr> <tr><td>G01</td><td>G1/8"</td></tr> <tr><td>G02</td><td>G1/4"</td></tr> <tr><td>G03</td><td>G3/8"</td></tr> <tr><td>G04</td><td>G1/2"</td></tr> </table>	Cónica BSPT BSPT thread		01	R1/8"	02	R1/4"	03	R3/8"	04	R1/2"	Métrica Metric Thread		M5	M5x0,8	M6	M6x1,0	Cilíndrica BSPP BSPP thread		G01	G1/8"	G02	G1/4"	G03	G3/8"	G04	G1/2"
Código	Tubo																																									
04	4mm																																									
06	6mm																																									
08	8mm																																									
10	10mm																																									
12	12mm																																									
14	14mm																																									
Cónica BSPT BSPT thread																																										
01	R1/8"																																									
02	R1/4"																																									
03	R3/8"																																									
04	R1/2"																																									
Métrica Metric Thread																																										
M5	M5x0,8																																									
M6	M6x1,0																																									
Cilíndrica BSPP BSPP thread																																										
G01	G1/8"																																									
G02	G1/4"																																									
G03	G3/8"																																									
G04	G1/2"																																									

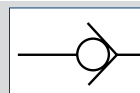

Las válvulas de bloqueo hacen más fáciles las labores de reparación y mantenimiento. Bloquean el paso del aire cuando el tubo está desconectado. Cuando el tubo es conectado, se permite el paso del fluido en ambos sentidos.

Stop fittings make easier all the ordinary repairs. They block the air flow when the tube is released. When the tube is connected the air flows again in two ways.

Sección interna - Construction

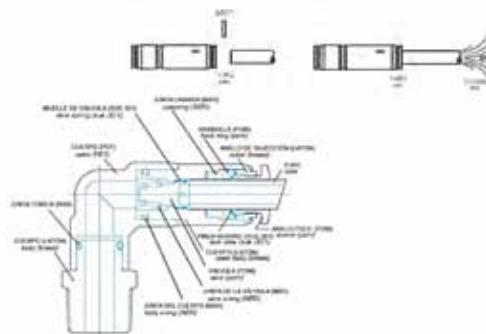



Datos Técnicos	
Fluidos aplicables	Aire comprimido
Materiales utilizados	Cuerpo: Latón niquelado y PBT
	Pinza de agarre: Acero SUS 301
	Junta : NBR sin silicona
Roscas	Gas cónica BSPT de R1/8" a R1/2" preteflonada
	Gas cilíndrica BSPP con junta tórica de G1/8" a G1/2"
	Métrica M5, M6
Presión de trabajo	De 0 a 10 Bar / De 15 a 150 PSI
Presión de vacío	-750mmHG (-750 torr)
Temperatura de trabajo	De 0°C a 60°C
Tubos utilizados	Poliamida (PA)
	Poliuretano (PU)
Producto conforme a la directiva 2002/95/EC RoHS	

Technical specifications	
Applicable fluids	Air
Materials used	Body: brass nickel plated e PBT
	Lock claw: steel SUS 301
	O'ring: NBR silicon free
Threads	BSPT from R1/8" a R1/2" teflon coated
	BSPP with OR from G1/8" to G1/2"
	Metric M5, M6
Working pressure	from 15 to 150 PSI / from 0 to 10 Bar
Negative pressure	-750mmHG (-750 torr)
Working temperature	from 32 to 140 °F / from 0°C to 60°C
Tubes used	Polyamide (PA)
	Polyurethane (PU)
Products in conformity with the directive 2002/95/EC RoHS	

Válvula de bloqueo recta rosca macho cónica BSPT • Male connector stop fitting BSPT thread

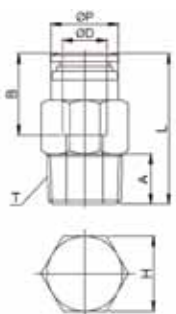
SPC	REFERENCIA	ØD	ØP	T	L	A	B	H (Hex)	Peso Weight(g)
	SPC0401	4	10,0	R1/8"	26,1	8,0	15,3	10	10,8
	SPC0601	6	12,0	R1/8"	28,8	8,0	17,0	12	12,8
	SPC0602			R1/4"		10,0		14	20,8
	SPC0802	8	14,0	R1/4"	33,3	10,0	18,6	14	19,7
	SPC0803			R3/8"		11,0		17	38,7
	SPC1002	10	17,0	R1/4"	35,6	10,0	20,3	17	28,5
	SPC1003			R3/8"		11,0		17	33,5
	SPC1004			R1/2"		14,0		21	60,5
	SPC1202	12	18,8	R1/4"	41,9	10,0	22,7	19	44,3
	SPC1203			R3/8"		11,0		19	58,3
SPC1204	R1/2"			14,0		21		66,3	

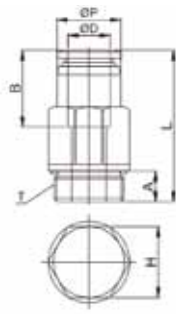

Válvula de bloqueo recta rosca macho cilíndrica BSPP • male connector stop fitting BSPP thread

SPC G	REFERENCIA	ØD	ØP	T	L	A	B	H (Hex)	Peso Weight(g)
	SPC04G01	4	10,3	G1/8"	25,5	5,0	15,5	12	14,8
	SPC06G01	6	12,0	G1/8"	27,7	5,0	17,0	12	13,8
	SPC06G02			G1/4"		6,5		15	23,8
	SPC08G02	8	14,0	G1/4"	31,9	6,5	18,6	15	22,7
	SPC08G03			G3/8"		6,5		17	34,7
	SPC10G02	10	17,0	G1/4"	34,9	6,5	20,3	17	30,5
	SPC10G03			G3/8"		6,5		17	35,5
	SPC10G04			G1/2"		8,0		21	57,5
	SPC12G02	12	18,8	G1/4"	43,3	6,5	22,7	19	49,3
	SPC12G03			G3/8"		6,5		21	62,3
SPC12G04	G1/2"			8,0		21		64,3	



Válvula de bloqueo a 90° rosca macho cónica BSPT • Male elbow stop fitting BSPT thread

SPL	REFERENCIA	ØD	ØP	T	L	E	A	B	H (Hex)	Peso Weight(g)
	SPL0401	4	10,0	R1/8"	29,8	34,5	8,0	15,3	10	19,8
	SPL0601	6	12,0	R1/8"	32,8	38,9	8,0	17,0	12	20,8
	SPL0602			R1/4"			10,0		14	30,8
	SPL0802	8	14,0	R1/4"	38,2	48,6	8,0	18,6	14	31,7
	SPL0803			R3/8"			10,0		14	38,7
	SPL1002	10	17,0	R1/4"	40,3	55,0	10,0	20,3	17	55,5
	SPL1003			R3/8"			11,0		17	65,5
	SPL1004			R1/2"			14,0		21	89,5
	SPL1203	12	18,8	R3/8"	45,7	63,7	11,0	22,7	19	83,3
	SPL1204			R1/2"			14,0		21	106,3

Válvula de bloqueo a 90° rosca macho cilíndrica BSPP y métrica • Male elbow stop fitting BSPP & metric thread

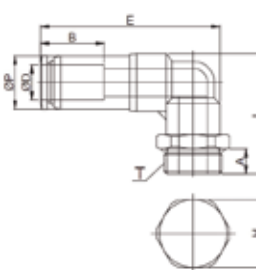
SPL G	REFERENCIA	ØD	ØP	T	L	E	A	B	H (Hex)	Peso Weight(g)
	SPL04M5	4	10,0	M5	27,3	34,5	4,6	15,3	10	15,8
	SPL04M6			M6	26,9		4,1		10	15,8
	SPL04G01			G1/8"	29,8		5,0		14	18,8
	SPL06M5	6	12,0	M5	30,3	38,9	4,6	17,0	12	29,8
	SPL06G01			G1/8"	29,8		5,0		14	22,8
	SPL06G02			G1/4"	31,8		6,5		17	29,8
	SPL08G01	8	14,0	G1/4"	32,4	49,9	5,0	18,6	14	30,0
	SPL08G02			G1/4"	34,4		6,5		17	37,7
	SPL08G03			G3/8"	33,9		6,5		20	41,7
	SPL10G02	10	17,0	G1/4"	31,8	55,0	6,5	20,3	17	49,5
	SPL10G03			G3/8"	38,5		6,5		20	56,5
	SPL10G04			G1/2"	37,3		8,0		24	68,5
	SPL12G03	12	18,8	G3/8"	40,2	63,7	6,5	22,7	20	71,3
	SPL12G04			G1/2"	41,7		8,0		24	84,3



Válvula de bloqueo recta intermedia tubo - tubo • Union connector stop fitting

SPU	REFERENCIA	ØD	ØP	L	B	Peso Weight(g)
	SPU04	4	10,5	42,1	15,7	6,6
	SPU06	6	12,5	46,0	17,0	7,4
	SPU08	8	14,8	53,7	19,1	12,4
	SPU10	10	17,5	58,2	20,2	21,4
	SPU12	12	20,5	67,1	22,7	35,2

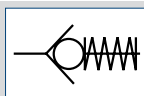

Designación Referencia - Model designation

CVPC	06	01	IN																						
Código Code	Diámetro Tubo Tube diameter	Rosca Thread size	Dirección del fluido																						
	<table border="1"> <tr><th>Código</th><th>Tubo</th></tr> <tr><td>04</td><td>4mm</td></tr> <tr><td>06</td><td>6mm</td></tr> <tr><td>08</td><td>8mm</td></tr> <tr><td>10</td><td>10mm</td></tr> <tr><td>12</td><td>12mm</td></tr> </table>	Código	Tubo	04	4mm	06	6mm	08	8mm	10	10mm	12	12mm	<table border="1"> <tr><th colspan="2">Cónica BSPT BSPT thread</th></tr> <tr><td>01</td><td>R1/8"</td></tr> <tr><td>02</td><td>R1/4"</td></tr> <tr><td>03</td><td>R3/8"</td></tr> <tr><td>04</td><td>R1/2"</td></tr> </table>	Cónica BSPT BSPT thread		01	R1/8"	02	R1/4"	03	R3/8"	04	R1/2"	Color de la anilla Sleeve colour Entrada: Azul-Blue Salida: Rojo-Red
Código	Tubo																								
04	4mm																								
06	6mm																								
08	8mm																								
10	10mm																								
12	12mm																								
Cónica BSPT BSPT thread																									
01	R1/8"																								
02	R1/4"																								
03	R3/8"																								
04	R1/2"																								



Componentes - Construction

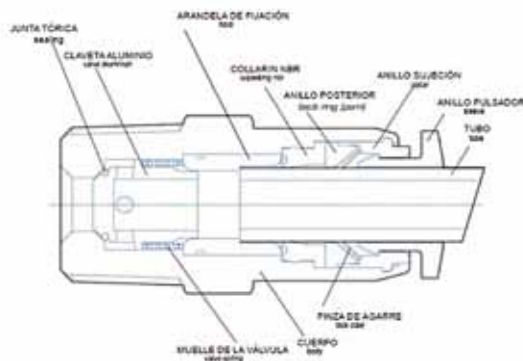

Ejemplo de aplicación - Applied example

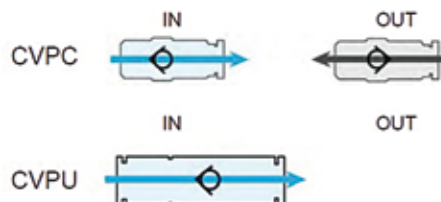

Datos Técnicos SERIE CVP

Fluidos aplicados	Aire, fluidos compatibles
Materiales utilizados	Cuerpo: aluminio (modelo CVPC)
	Termoplástico PBT (modelo CVPU04, 06 y 08)
	Aluminio (modelo CVPU10 y 12)
	Pinza de agarre: acero SUS 301
	Junta tórica: NBR sin silicona
Roscas	Gas cónica BSPT de R1/8" - R1/2" preteflonada
Presión de trabajo	0,1 a 10 bar.
Presión de vacío	-750mmHG (-750 torr)
Presión mínima de apertura	0,1 bar
Temperatura de trabajo	De 32 a 140 °F / De 0°C a 60°C
Tubos utilizados	Poliamida (PA)
	Poliuretano (PU)

Datos Técnicos SERIE VAR

Ver datos de las válvulas antirretornos serie VAR en páginas A78 - A79

Producto conforme a la directiva 2002/95/EC **RoHS**

Technical specifications CVP serie

Applicable fluids	Air
Materials used	Body: aluminium (code CVPC)
	PBT (code CVPU)
	Aluminium (code CVPC10 y 12)
	Lock claw: steel SUS 301
	O'ring: NBR silicon free
Threads	BSPT from R1/8" to R1/2" teflon coated
Working pressure	From 0,1 to 150 PSI / from 0,1 to 10 Bar
Negative pressure	-29,5 in Hg /-750mmHG (-750 torr)
Minimum opening pressure	0,1 bar
Working temperature	From 32 to 140 °F / from 0°C to 60°C
Tubes used	Polyamide (PA)
	Polyurethane (PU)

Technical specifications VAR series

See specifications on pages A78 - A79

Products in conformity with the directive 2002/95/EC **RoHS**

Válvula antirretorno rosca macho cónica BSPT - SALIDA en latón • Male connector check valve BSPT thread - OUT in brass

CVPC	REFERENCIA	ØD	T	ØP	L	A	B	H (Hex)	Peso Weight(g)
	CVPC0401	4	R1/8"	10,0	27,3	8,0	15,3	10	9,8
	CVPC0601	6	R1/8"	11,9	32,6	8,0	16,3	12	12,8
	CVPC0602	6	R1/4"	11,9	32,6	10,0	16,3	14	19,8
	CVPC0801	8	R1/8"	14,0	34,9	8,0	18,3	14	18,7
	CVPC0802	8	R1/4"	14,0	37,2	10,0	18,3	14	20,7
	CVPC1003	10	R3/8"	23,0	56,3	11,0	20,3	22	45,5
	CVPC1004	10	R1/2"	23,0	58,3	14,0	20,3	22	63,5
	CVPC1203	12	R3/8"	25,0	62,3	12,0	23,3	24	48,3
CVPC1204	12	R1/2"	25,0	65,3	14,0	23,3	24	68,3	

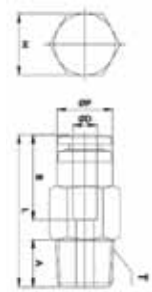

Válvula antirretorno rosca macho cónica BSPT - ENTRADA en latón • Male connector check valve BSPT thread - IN in brass

CVPC-EN	REFERENCIA	ØD	T	ØP	L	A	B	H (Hex)	Peso Weight(g)
	CVPC0401-EN	4	R1/8"	10,0	27,3	8,0	15,3	10	9,8
	CVPC0601-EN	6	R1/8"	11,9	32,6	8,0	16,3	12	12,8
	CVPC0602-EN	6	R1/4"	11,9	32,6	10,0	16,3	14	19,8
	CVPC0801-EN	8	R1/8"	14,0	34,9	8,0	18,3	14	18,7
	CVPC0802-EN	8	R1/4"	14,0	37,2	10,0	18,3	14	20,7
	CVPC1003-EN	10	R3/8"	23,0	56,3	11,0	20,3	22	45,5
	CVPC1004-EN	10	R1/2"	23,0	58,3	14,0	20,3	22	63,5
	CVPC1203-EN	12	R3/8"	25,0	62,3	12,0	23,3	24	48,3
CVPC1204-EN	12	R1/2"	25,0	65,3	14,0	23,3	24	68,3	

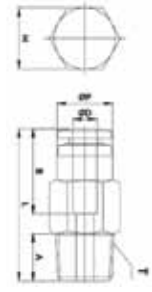

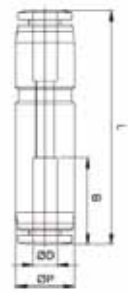

Válvula antirretorno recta en plástico • Union connector check valve in plastic

CVPU	REFERENCIA	ØD	ØP	L	B	Peso Weight(g)
	CVPU04	4	10,5	42,3	15,7	5,6
	CVPU06	6	12,5	47,5	17,0	8,4
	CVPU08	8	14,8	56,4	19,1	13,4
	CVPU10	10	23,0	65,2	20,3	16,4
	CVPU12	12	25,0	73,0	23,3	31,2



Válvula antirretorno rosca hembra cilíndrica BSPP en latón • Check valve BSPP thread in yellow brass with NBR sealing

VAR-L	REFERENCIA	T	PN (Bar)	PA standard (Bar)	L mm	H (Hex)	Peso Weight(g)
	VAR-12L	G1/8"	20	0,35	36,0	17	49,0
	VAR-25L	G1/4"	20	0,3	38,5	17	41,0
	VAR-50L	G3/8"	20	0,25	45,0	22	86,0
	VAR-100L	G1/2"	20	0,08	56,0	27	155,0
	VAR-150L	G3/4"	20	0,1	66,5	34	281,0
	VAR-200L	G1	20	0,8	79,0	40	412,0



Válvula antirretorno rosca hembra cilíndrica BSPP INOX AISI 303 • Check valve BSPP thread INOX AISI 303

VAR-X	REFERENCIA	T	PN (Bar)	PA min (Bar)	L mm	H (Hex)	Peso Weight(g)
	VAR-12X	G1/8"	20	0,35	36,0	17	45,0
	VAR-25X	G1/4"	20	0,3	38,5	17	39,0
	VAR-50X	G3/8"	20	0,25	45,0	22	81,0
	VAR-100X	G1/2"	20	0,08	56,0	27	144,0
	VAR-150X	G3/4"	20	0,1	66,5	36	321,0
	VAR-200X	G1	20	0,8	79,0	41	388,0

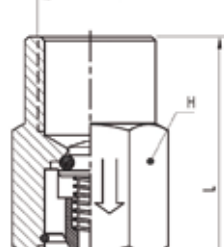

Válvula antirretorno rosca hembra cilíndrica BSPP INOX AISI 316
Check valve BSPP thread INOX AISI 316

AISI 316

VAR-X316	REFERENCIA	T	PN (Bar)	PA min (Bar)	L mm	H (Hex)	Peso Weight(g)
	VAR-12X-316	G1/8"	20	0,35	36,0	17	45,0
	VAR-25X-316	G1/4"	20	0,3	38,5	17	39,0
	VAR-50X-316	G3/8"	20	0,25	45,0	22	81,0
	VAR-100X-316	G1/2"	20	0,08	56,0	27	144,0
	VAR-150X-316	G3/4"	20	0,1	66,5	36	321,0
	VAR-200X-316	G1	20	0,8	79,0	41	388,0





RACORES ROSCADOS · *Thread Fittings*

NUEVO RACORES CON TUERCA MOLETEADA EN RESINA ACETAL

Acetal resin push-on fittings

NUEVO RACORES CON TUERCA MOLETEADA EN POLIPROPILENO

Polypropylene resin push-on fittings

NUEVO RACORES CON TUERCA MOLETEADA EN PVDF

PVDF push-on fittings

RACORES CON TUERCA MOLETEADA EN LATÓN NIQUELADO

Brass push-on fittings

AISI 316

RACORES CON TUERCA MOLETEADA EN ACERO INOX. AISI 316

Push-on fittings INOX AISI 316

RACORES CON BICONO EN LATÓN NIQUELADO · *Brass compression fittings*

AISI 316

RACORES CON BICONO EN ACERO INOX. AISI 316 - DIN 2353

Compression fittings INOX AISI 316 - DIN 2353

ACCESORIOS ROSCADOS EN LATÓN NIQUELADO · *Brass standard fittings*

AISI 316

ACCESORIOS ROSCADOS EN INOX AISI 303 - AISI 316

Standard fittings INOX AISI 303 - AISI 316

ACCESORIOS ROSCADOS EN INOX AISI 316 MICROFUSIÓN

Standard fittings INOX AISI 316 microfusion

DISTRIBUIDORES DE ALUMINIO · *Distribution manifolds alluminium*

NUEVO

Designación Referencia - Model designation

IMORARM

06

01

↓
Código
Code

↓
Diámetro Tubo
Tube diameter

↓
Rosca
Thread size



Código	O.D.	I.D.
04	4mm	2,5mm
06	6mm	4mm
08	8mm	5,5mm
10	10mm	6,5mm
12	12mm	8mm

Cónica BSPT BSPT thread	
01	R1/8"
02	R1/4"
03	R3/8"
04	R1/2"

Datos Técnicos

Fluidos compatibles	Aire comprimido
Materiales utilizados	Resina acetálica
Rosca	Gas cónica BSPT de R1/8" a R1/2"
Presión de trabajo	de -750mmHg a 10 bar
Temperatura de trabajo	de 0°C a 60°C
Tubos utilizados	Poliuretano (PU)
Características	Buena resistencia a la corrosión y a las sustancias químicas
Producto conforme a la directiva 2002/95/EC 	
Producto conforme a la directiva 1907/2006 	

Technical specifications

Fluid types	Compressed air
Construction materials	Acetal resin
Threads	BSPT from R1/8" to R1/2"
Working pressure	From -750mmHg to 10 bar
Working temperature	From 0°C to 60°C
Tubes used	Polyurethane (PU)
Advantages	Good tolerance to corrosion and chemicals
Products in conformity with the directive 2002/95/EC 	
Products in conformity with the directive 1907/2006 	

PRECAUCIÓN

Los productos están fabricados en plástico y es necesario usar recubrimiento de teflón sobre la rosca para su instalación para prevenir fugas de aire.
Para conectar el tubo, inserte el tubo hasta el final y apriete la tuerca antes de usarlo. Asegúrese de evitar un par de apriete excesivo.
Para reutilizar el tubo cortar la parte presionada.

PRECAUTIONS

The products are made in plastic and it's necessary to use teflon coating over the thread for installation in order and to prevent air leakage. Be sure to prevent excessive torque when screwing the fittings.
To connect the tube, insert the tube to the end and tight the nut before use.
Cut the pressed part of the tube before connection to reuse the released tube.



Conexión rosca macho cónica BSPT • Male connector BSPT thread

IMORARM	REFERENCIA	ØD	T	L	A	H1 (Hex)	H2 (Hex)	Peso Weight(g)
	IMORARM04R01	4X2,5	R1/8"	24,5	8	10	12	2
	IMORARM06R01	6X4	R1/8"	28,5	7	12	13	3
	IMORARM06R02		R1/4"	30,5	9	12	15	4
	IMORARM08R01	8X5,5	R1/8"	30	9	14	14	5
	IMORARM08R02		R1/4"	29	9	14	17	5
	IMORARM08R03		R3/8"	31,7	10,2	14	19	6
	IMORARM10R02	10X6,5	R1/4"	33,4	9,2	17	17	7
	IMORARM10R03		R3/8"	34,9	10,2	17	19	7
	IMORARM12R02	12X8	R1/4"	39	9,2	19	17	9
	IMORARM12R03		R3/8"	41,2	10,2	19	19	9
IMORARM12R04	R1/2"		45	15	19	22	13	

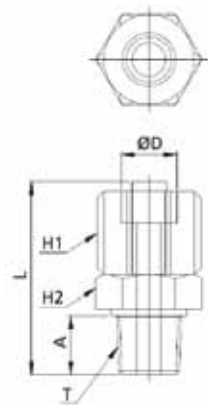

Codo rosca macho cónica BSPT • Male elbow BSPT thread

IMORARCM	REFERENCIA	ØD	T	L	E	A	H (Hex)	Peso Weight(g)
	IMORARCM0401	4X2,5	R1/8"	16,5	16	8	12	3
	IMORARCM0601	6X4	R1/8"	18	21,5	8,5	12	5
	IMORARCM0602		R1/4"	18,7	23,5	9	12	7
	IMORARCM0801	8X5,5	R1/8"	17	21	8	14	6
	IMORARCM0802		R1/4"	19	22,5	10	14	8
	IMORARCM0803		R3/8"	20,5	23,8	10,2	14	10
	IMORARCM1002	10X6,5	R1/4"	22	24,1	12	17	10
	IMORARCM1003		R3/8"	23	27,1	12	17	12
	IMORARCM1202	12X8	R1/4"	23	32,2	11	19	14
	IMORARCM1203		R3/8"	25	32,2	12	19	16
IMORARCM1204	R1/2"		28	34	15	19	19	

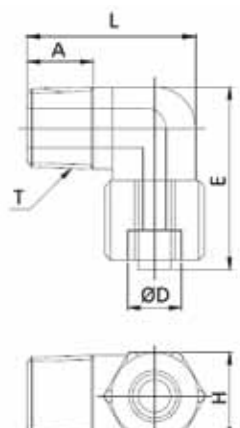





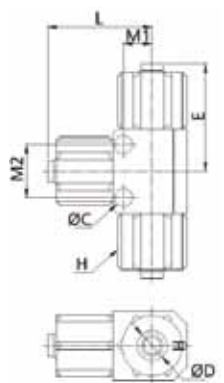

"T" union • Union tee

IMORART	REFERENCIA	ØD	L	E	ØC	M1	M2	H (Hex)	Peso Weight(g)
	IMORART04	4X2,5	19	18	2,5	5,7	9,5	10	4
	IMORART06	6X4	24,3	24,2	4,3	5,7	11,2	12	11
	IMORART08	8X5,5	24,1	24,8	4,3	6,6	12,2	14	14
	IMORART10	10X6,5	30	27	4,3	8,3	13,4	17	24
	IMORART12	12X8	36,9	34	4,3	9,3	13,7	19	26



Tubo de poliuretano en base de poliéster • Polyurethane tube on polyester basis

PUES	REFERENCIA	Tamaños O.D. x I.D.	Tolerancia externa del tubo	Radio de curvatura mínimo a 23°C (mm)	Presión de trabajo a 23°C (Bar)	Presión de explosión a 23°C (Bar)	Dureza	Colores disponibles
	PUES0425	4x2,5	±0,1	12	10	30	Shore 98A	
	PUES0604	6x4	±0,1	15	8,5	25,5	Shore 98A	
	PUES0855	8x5,5	±0,1	20	8,5	25,5	Shore 98A	
	PUES1065	10x6,5	±0,15	25	8,5	25,5	Shore 98A	
	PUES1208	12x8	±0,15	35	8,5	25,5	Shore 98A	

NUEVO

Designación de la referencia - Model designation

IMOPPRH

06

01

↓
Código
Code



↓
Diámetro Tubo
Tube diameter

↓
Rosca
Thread size

Código	O.D.	I.D.
06	6mm	4mm
08	8mm	5,5mm
10	10mm	7mm
12	12mm	9mm
14	1/4"	0,17"

Cónica BSPT BSPT thread	
01	R1/8"
02	R1/4"
03	R3/8"
04	R1/2"
05	R3/4"

Datos Técnicos	
Fluidos compatibles	Aire comprimido, agua y fluidos compatibles con los materiales de construcción
Materiales utilizados	Polipropileno reforzado con fibra de vidrio
Rosca	Gas cónica BSPT de R1/8" a R3/4"
Presión de trabajo	Por encima de 14 bar a 20°C
Temperatura de trabajo	de 4°C a 60°C
	Sujeto a la aplicación
Características	Buena resistencia a sustancias químicas y fertilizantes
Tubos utilizados	Poliuretano (PU)
	Polietileno (PE)
	Poliamida (PA)
Producto conforme a la directiva 2002/95/EC 	
Producto conforme a la directiva 1907/2006 	

Technical specifications	
Fluid types	Compressed air, wáter and fluids suitable with construction materials
Construction materials	Fiberglass reinforced polypropylene
Threads	BSPT from R1/8" to R3/4"
Working pressure	Up to 14 bar at 20°C
Working temperature	From 4°C to 60°C
	Subject to application
Advantages	Good resistance to chemicals and fertilizers
Tubes used	Polyamide (PA)
	Polyurethane (PU)
	Polyethylene (PE)
Products in conformity with the directive 2002/95/EC 	
Products in conformity with the directive 1907/2006 	

PRECAUCIÓN

Los productos están fabricados en plástico y es necesario usar recubrimiento de teflón sobre la rosca para su instalación para prevenir fugas de aire.
Para conectar el tubo, inserte el tubo hasta el final y apriete la tuerca antes de usarlo. Asegúrese de evitar un par de apriete excesivo.
Para reutilizar el tubo cortar la parte presionada.

PRECAUTIONS

The products are made in plastic and it's necessary to use teflon coating over the thread for installation in order and to prevent air leakage. Be sure to prevent excessive torque when screwing the fittings.
To connect the tube, insert the tube to the end and tight the nut before use.
Cut the pressed part of the tube before conection to reuse the released tube.





Disponible bajo pedido también en pulgadas y rosca NPT.

Los datos técnicos y gráficos no son vinculantes. - Drawing and technical date are not binding.

Conector rosca hembra cónica BSPT • Female connector BSPT thread

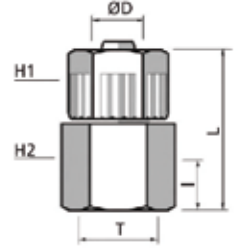
IMOPPRH	REFERENCIA	ØD O.D./ I.D.	T	I	L	H1 (Hex)	H2 (Hex)	Peso Weight(g)
	IMOPPRH0601	6X4	R1/8"	10	26,3	14	14	3
	IMOPPRH0602		R1/4"	11	28	14	17	3
	IMOPPRH0801	8X5,5	R1/8"	9,5	26,3	14	14	3
	IMOPPRH0802		R1/4"	11	28	14	17	4
	IMOPPRH0803		R3/8"	11,2	30,5	14	22	5
	IMOPPRH0804		R1/2"	13,5	32,5	14	26	6
	IMOPPRH1002	10X7	R1/4"	10	32	17	17	6
	IMOPPRH1003		R3/8"	11	33	17	22	7
	IMOPPRH1004		R1/2"	13,8	35,5	17	26	7

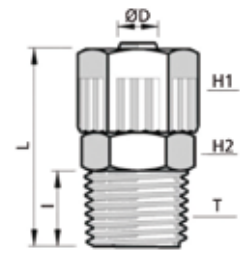

Conector rosca macho cónica BSPT • Male connector BSPT thread

IMOPPRM	REFERENCIA	ØD O.D./ I.D.	T	I	L	H1 (Hex)	H2 (Hex)	Peso Weight(g)
	IMOPPRM0601	6X4	R1/8"	8	27	14	13	3
	IMOPPRM0602		R1/4"	10,5	30	14	15	3
	IMOPPRM0604		R1/2"	13	31,5	14	22	6
	IMOPPRM0605		R3/4"	9	23	14	27	8
	IMOPPRM0801	8X5,5	R1/8"	8	27	14	13	3
	IMOPPRM0802		R1/4"	10,5	30	14	15	3
	IMOPPRM0803		R3/8"	10,5	31,5	14	18	4
	IMOPPRM0804		R1/2"	13	34	14	22	5
	IMOPPRM0805	R3/4"	9	27,5	14	27	8	
	IMOPPRM1002	10X7	R1/4"	10,5	36	17	17	4
	IMOPPRM1003		R3/8"	10,5	36	17	17	5
	IMOPPRM1004		R1/2"	12	39	17	22	6
	IMOPPRM1005	R3/4"	13	40	17	27	6	
	IMOPPRM1202	12X9	R1/4"	10,5	34	19	14	6
	IMOPPRM1203		R3/8"	10,5	36	19	18	7
IMOPPRM1204	R3/4"		12,5	37	19	22	7	

Unión conector • Union connector

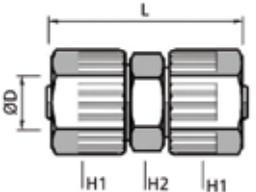
IMOPPRU	REFERENCIA	ØD O.D./I.D.	L	H1 (Hex)	H2 (Hex)	Peso Weight(g)
	IMOPPRU0606	6X4	32,5	14	14	4
	IMOPPRU0808	8X5,5	32,5	14	14	4
	IMOPPRU0806	8X5,5 - 6X4	32,5	14	14	4
	IMOPPRU1212	12X9	32,5	19	18	8

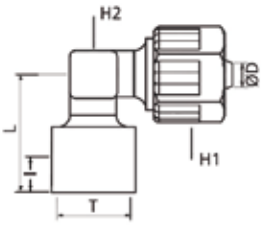

Codo rosca hembra cónica BSPT • Female elbow BSPT thread

IMOPPRCH	REFERENCIA	ØD O.D./ I.D.	T	I	L	H1 (Hex)	H2 (Hex)	Peso Weight(g)
	IMOPPRCH0601	6X4	R1/8"	10,5	19,5	14	9	5
	IMOPPRCH0602	6X4	R1/4"	12,3	22,5	14	9	5
	IMOPPRCH0802	8X5,5	R1/4"	12,3	22,5	14	9	6

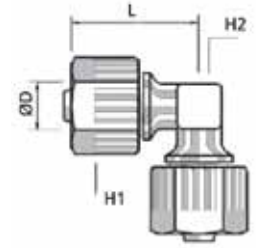

Unión conector • Union elbow

IMOPPRCC	REFERENCIA	ØD O.D./I.D.	L	H1 (Hex)	H2 (Hex)	Peso Weight(g)
	IMOPPRCC06	6X4	23,3	14	8	4
	IMOPPRCC08	8X5,5	23,5	14	8	4
	IMOPPRCC12	12X9	32	19	15	10



Codo rosca macho cónica BSPT • Male elbow BSPT thread

IMOPPRCM	REFERENCIA	ØD O.D./I.D.	T	I	L1	L2	H1 (Hex)	H2 (Hex)	Peso Weight(g)
	IMOPPRCM0601	6X4	R1/8"	8	18,5	22,5	14	8	2
	IMOPPRCM0602		R1/4"	10	23	22,5	14	8	3
	IMOPPRCM0801	8X5,5	R1/8"	8,5	18,5	23	14	8	3
	IMOPPRCM0802		R1/4"	11	23	23	14	8	3
	IMOPPRCM0803		R3/8"	11	23,5	23	14	8	5
	IMOPPRCM1202	12X9	R1/4"	10	24	33	19	15	7
	IMOPPRCM1203		R3/8"	10	24,5	33	19	15	6
	IMOPPRCM1204		R1/2"	13	28,5	33	19	15	9

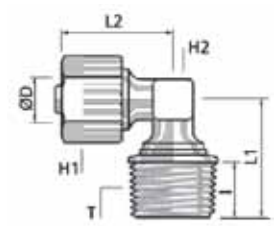

"T" rosca macho cónica BSPT • Male tee BSPT thread

IMOPPRTC	REFERENCIA	ØD O.D./I.D.	T	I	L1	L2	H1 (Hex)	H2 (Hex)	Peso Weight(g)
	IMOPPRTC0601	6X4	R1/8"	9	19	23,3	14	8	6
	IMOPPRTC0602		R1/4"	11	21	23,3	14	8	6
	IMOPPRTC0801	8X5,5	R1/8"	9	19	23,3	14	8	5
	IMOPPRTC0802		R1/4"	11	21	23,3	14	8	6
	IMOPPRTC0803		R3/8"	11	21	23,3	14	8	7
	IMOPPRTC1202	12X9	R1/4"	11	21	23,3	14	8	12
	IMOPPRTC1203		R3/8"	10,7	24,5	33,5	19	15	14
	IMOPPRTC1204		R1/2"	15	28,5	33	19	15	15

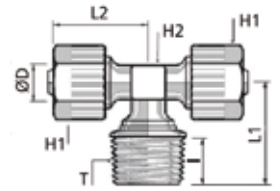

"T" lateral rosca macho cónica BSPT • Lateral male tee BSPT thread

IMOPPRTL	REFERENCIA	ØD O.D./ I.D.	T	I	L	H1 (Hex)	H2 (Hex)	Peso Weight(g)
	IMOPPRTL0601	6X4	R1/8"	8,5	23,3	14	8	5
	IMOPPRTL0602		R1/4"	11	23,3	14	8	5
	IMOPPRTL0801	8X5,5	R1/8"	8,5	23,3	14	8	5
	IMOPPRTL0802		R1/4"	11	23,3	14	8	5
	IMOPPRTL0803		R3/8"	10	23,3	14	8	7
	IMOPPRTL1202	12X9	R1/4"	10	33	19	15	12
	IMOPPRTL1203		R3/8"	11	33	19	15	14
	IMOPPRTL1204		R1/2"	15	33	19	15	15

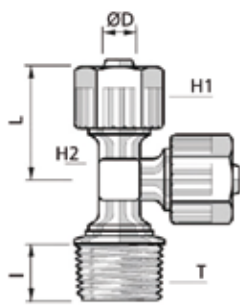

"T" unión • Union tee

IMOPPRT	REFERENCIA	ØD O.D./I.D.	L	H1 (Hex)	H2 (Hex)	Peso Weight(g)
	IMOPPRT06	6X4	22	14	8	7
	IMOPPRT08	8X5,5	22	14	8	5
	IMOPPRT12	12X9	32	19	14	14

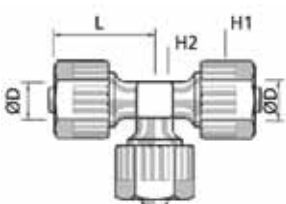

Cuerpo banjo orientable • Single banjo body

IMOPPRK	REFERENCIA	ØD O.D./ I.D.	ØC	E	L1	L2	H (Hex)	Peso Weight(g)
	IMOPPRK0601	6X4	1/8"	20	23	10	14	3
	IMOPPRK0602		1/4"	22	22	10	14	3
	IMOPPRK0801	8X5,5	1/8"	20	23	10	14	4
	IMOPPRK0802		1/4"	22	22	10	14	4

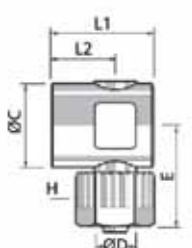

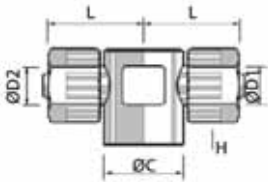

Doble cuerpo banjo orientable • Double banjo body

IMOPPRDK	REFERENCIA	ØD1 O.D./I.D.	ØD2 O.D./I.D.	ØC	L	H (Hex)	Peso Weight(g)
	IMOPPRDK060601	6X4	6X4	1/8"	20,5	14	4
	IMOPPRDK060602	6X4	6X4	1/4"	22	14	6
	IMOPPRDK080601	8X5,5	6X4	1/8"	20,5	14	6
	IMOPPRDK080602	8X5,5	6X4	1/4"	22	14	6
	IMOPPRDK080801	8X5,5	8X5,5	1/8"	20,5	14	6
	IMOPPRDK080802	8X5,5	8X5,5	1/4"	22	14	6

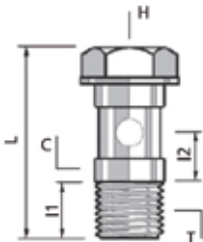

Espiga banjo • Single banjo stem

IMOPPRE	REFERENCIA	T	ØC	I1	I2	L	H (Hex)	Peso Weight(g)
	IMOPPRE01	G1/8"	1/8"	9	10	37,5	16	3
	IMOPPRE02	G1/4"	1/4"	12	10	37,5	16	3



Doble espiga banjo • Double banjo stem

IMOPPRDE	REFERENCIA	T	ØC	I1	I2	I3	L	H2 (Hex)	Peso Weight(g)
	IMOPPRDE01	G1/8"	1/8"	8,5	10	27,5	59,5	16	3
	IMOPPRDE02	G1/4"	1/4"	11	12	27,5	60	16	5

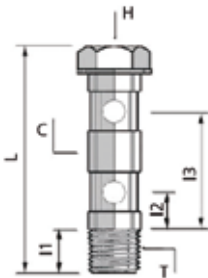

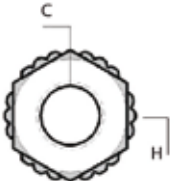

Tuerca de cierre • Lock nut

IMOTUBPPR	REFERENCIA	ØD O.D./I.D.	ØC	H2 (Hex)	Peso Weight(g)
	IMOTUBPPR06	6X4	6,2	14	1
	IMOTUBPPR08	8X5,5	8,1	14	2
	IMOTUBPPR10	10X7	10,2	17	3
	IMOTUBPPR12	12X9	12,8	19	4

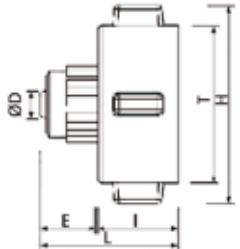

Conector rosca hembra cónica BSPT • Female connector BSPT thread

IMOPPRHC	REFERENCIA	ØO.D.	T	I	E	L	H (Hex)	Peso Weight(g)
	IMOPPRHC0205	1X4"	R3/4"	16,7	14,5	31	14	7
	IMOPPRHC0605	6X4	R3/4"	16,7	14,5	31	14	7
	IMOPPRHC0805	8X5,5	R3/4"	16,7	14,5	31	14	8
APTO PARA DISTRIBUIDORES AUTOMÁTICOS DE CONEXIÓN AL SUMINISTRO DE AGUA. SUITABLE FOR VENDING MACHINES CONNECTION TO WATER SUPPLY.								



Codo rosca hembra cónica BSPT • Female elbow BSPT thread

IMOPPRMC	REFERENCIA	ØO.D.	T	I	E	L	H (Hex)	Peso Weight(g)
	IMOPPRMC0805	8X5,5	R3/4"	16,8	21,5	36,8	30	8
	APTO PARA DISTRIBUIDORES AUTOMÁTICOS DE CONEXIÓN AL SUMINISTRO DE AGUA. SUITABLE FOR VENDING MACHINES CONNECTION TO WATER SUPPLY.							

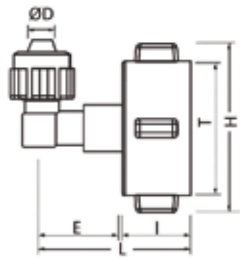

NUEVO

Designación Referencia - Model designation

IMOPVRH	01	06		
↓	↓	↓		
Código Code	Rosca Thread size	Diámetro Tubo Tube diameter		
	Cónica BSPT BSPT thread	Código	O.D.	I.D.
	01 R1/8"	06	6mm	4mm
	02 R1/4"	08	8mm	5,5mm
	03 R3/8"	10	10mm	7mm
	04 R1/2"	12	12mm	9mm
	05 R3/4"			

Datos Técnicos	
Fluidos compatibles	Aire comprimido, agua y fluidos compatibles con los materiales de construcción
Materiales utilizados	Polifluoruro de vinilideno (PVDF)
Rosca	Gas cónica BSPT de R1/8" a R3/4"
Presión de trabajo	Por encima de 14 bar a 20°C
Temperatura de trabajo	De -62°C a 107°C Sujeto a la aplicación
Características	Buena resistencia a casi todo tipo de fluidos muy corrosivos como ácidos, bases débiles, halógenos, alcoholes, sales oxidantes pesadas, detergentes, etc. Resistente a los rayos UV. Resistencia nuclear.
Tubos utilizados	Poliuretano (PU) Polietileno (PE) Poliamida (PA) PTFE FEP
Producto conforme a la directiva 2002/95/EC	
Producto conforme a la directiva 1907/2006	

Technical specifications	
Fluid types	Compressed air, wáter and fluids suitable with construction materials
Construction materials	Polyvinylidene fluoride (PVDF)
Threads	BSPT from R1/8" to R3/4"
Working pressure	Up to 14 bar at 20°C
Working temperature	From -62°C to 107°C Subject to application
Advantages	Good resistance to almost all kind of very corrosive fluids like acids, weak bases, halogens, alcohols, salts, heavy duty oxidants, detergents, etc. UV resistant. Nuclear resistant.
Tubes used	Polyamide (PA) Polyurethane (PU) Polyethylene (PE) PTFE FEP
Products in conformity with the directive 2002/95/EC	
Products in conformity with the directive 1907/2006	

PRECAUCIÓN

Los productos están fabricados en plástico y es necesario usar recubrimiento de teflón sobre la rosca para su instalación para prevenir fugas de aire.

Para conectar el tubo, inserte el tubo hasta el final y apriete la tuerca antes de usarlo. Asegúrese de evitar un par de apriete excesivo.

Para reutilizar el tubo cortar la parte presionada.

PRECAUTIONS

The products are made in plastic and it's necessary to use teflon coating over the thread for installation in order and to prevent air leakage. Be sure to prevent excessive torque when screwing the fittings.

To connect the tube, insert the tube to the end and tight the nut before use.

Cut the pressed part of the tube before conection to reuse the released tube.



Conector rosca hembra cónica BSPT • Female connector BSPT thread

IMOPVRH	REFERENCIA	ØD O.D./ I.D.	T	I	L	H1 (Hex)	H2 (Hex)	Peso Weight(g)
	IMOPVRH0601	6X4	R1/8"	10	26,3	14	14	3
	IMOPVRH0602		R1/4"	11	28	14	17	3
	IMOPVRH0801	8X5,5	R1/8"	9,5	26,3	14	14	3
	IMOPVRH0802		R1/4"	11	28	14	17	4
	IMOPVRH0803		R3/8"	11,2	30,5	14	22	5
	IMOPVRH0804		R1/2"	13,5	32,5	14	26	6
	IMOPVRH1002	10X7	R1/4"	10	32	17	17	6
	IMOPVRH1003		R3/8"	11	33	17	22	7
	IMOPVRH1004		R1/2"	13,8	35,5	17	26	7

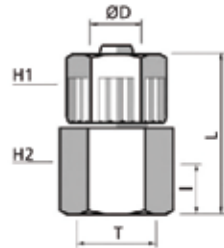

Conector rosca macho cónica BSPT • Male connector BSPT thread

IMOPVRM	REFERENCIA	ØD O.D./ I.D.	T	I	L	H1 (Hex)	H2 (Hex)	Peso Weight(g)
	IMOPVRM0601	6X4	R1/8"	8	27	14	13	3
	IMOPVRM0602		R1/4"	10,5	30	14	15	3
	IMOPVRM0604		R1/2"	13	31,5	14	22	6
	IMOPVRM0605		R3/4"	9	23	14	27	8
	IMOPVRM0801	8X5,5	R1/8"	8	27	14	13	3
	IMOPVRM0802		R1/4"	10,5	30	14	15	3
	IMOPVRM0803		R3/8"	10,5	31,5	14	18	4
	IMOPVRM0804		R1/2"	13	34	14	22	5
	IMOPVRM0805		R3/4"	9	27,5	14	27	8
	IMOPVRM1002	10X7	R1/4"	10,5	36	17	17	4
	IMOPVRM1003		R3/8"	10,5	36	17	17	5
	IMOPVRM1004		R1/2"	12	39	17	22	6
	IMOPVRM1005	R3/4"	13	40	17	27	6	
	IMOPVRM1202	12X9	R1/4"	10,5	34	19	14	6
	IMOPVRM1203		R3/8"	10,5	36	19	18	7
IMOPVRM1204	R3/4"		12,5	37	19	22	7	

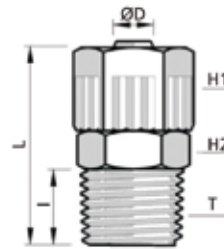

Unión conector • Union connector

IMOPVRU	REFERENCIA	ØD O.D./I.D.	L	H1 (Hex)	H2 (Hex)	Peso Weight(g)
	IMOPVRU0606	6X4	32,5	14	14	4
	IMOPVRU0808	8X5,5	32,5	14	14	4
	IMOPVRU0806	8X5,5 - 6X4	32,5	14	14	4
	IMOPVRU1212	12X9	40,6	19	18	8

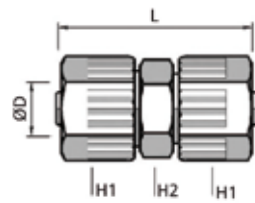

Codo rosca hembra cónica BSPT • Female elbow BSPT thread

IMOPVRCH	REFERENCIA	ØD O.D./ I.D.	T	I	L	H1 (Hex)	H2 (Hex)	Peso Weight(g)
	IMOPVRCH0601	6X4	R1/8"	10,5	19,5	14	9	5
	IMOPVRCH0602	6X4	R1/4"	12,3	22,5	14	9	5
	IMOPVRCH0802	8X5,5	R1/4"	12,3	22,5	14	9	6

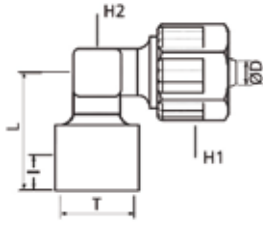

Unión codo • Union elbow

IMOPVRCC	REFERENCIA	ØD O.D./I.D.	L	H1 (Hex)	H2 (Hex)	Peso Weight(g)
	IMOPVRCC06	6X4	23,3	14	8	4
	IMOPVRCC08	8X5,5	23,5	14	8	4
	IMOPVRCC12	12X9	32	19	15	10

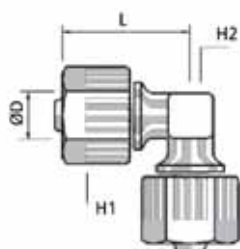

Codo rosca macho cónica BSPT • Male elbow BSPT thread

IMOPVRCM	REFERENCIA	ØD O.D./I.D.	T	I	L1	L2	H1 (Hex)	H2 (Hex)	Peso Weight(g)
	IMOPVRCM0601	6X4	R1/8"	8	18,5	22,5	14	8	2
	IMOPVRCM0602		R1/4"	10	23	22,5	14	8	3
	IMOPVRCM0801	8X5,5	R1/8"	8,5	18,5	23	14	8	3
	IMOPVRCM0802		R1/4"	11	23	23	14	8	3
	IMOPVRCM0803		R3/8"	11	23,5	23	14	8	5
	IMOPVRCM1202	12X9	R1/4"	10	24	33	19	15	7
	IMOPVRCM1203		R3/8"	10	24,5	33	19	15	6
IMOPVRCM1204	R1/2"		13	28,5	33	19	15	9	

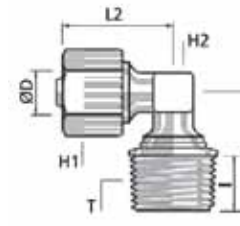

"T" rosca macho cónica BSPT • Male tee BSPT thread

IMOPVRTC	REFERENCIA	ØD O.D./I.D.	T	I	L1	L2	H1 (Hex)	H2 (Hex)	Peso Weight(g)
	IMOPVRTC0601	6X4	R1/8"	9	19	23,3	14	8	6
	IMOPVRTC0602		R1/4"	11	21	23,3	14	8	6
	IMOPVRTC0801	8X5,5	R1/8"	9	19	23,3	14	8	5
	IMOPVRTC0802		R1/4"	11	21	23,3	14	8	6
	IMOPVRTC0803		R3/8"	11	21	23,3	14	8	7
	IMOPVRTC1202	12X9	R1/4"	11	21	23,3	14	8	12
	IMOPVRTC1203		R3/8"	10,7	24,5	33,5	19	15	14
	IMOPVRTC1204		R1/2"	15	28,5	33	19	15	15

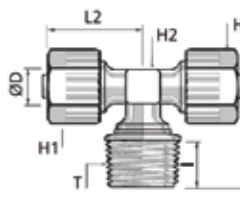

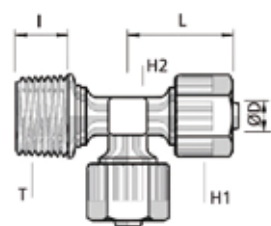

"T" lateral rosca macho cónica BSPT • Lateral male tee BSPT thread

IMOPVRTL	REFERENCIA	ØD O.D./ I.D.	T	I	L	H1 (Hex)	H2 (Hex)	Peso Weight(g)
	IMOPVRTL0601	6X4	R1/8"	8,5	23,3	14	8	5
	IMOPVRTL0602		R1/4"	11	23,3	14	8	5
	IMOPVRTL0801	8X5,5	R1/8"	8,5	23,3	14	8	5
	IMOPVRTL0802		R1/4"	11	23,3	14	8	5
	IMOPVRTL0803		R3/8"	10	23,3	14	8	7
	IMOPVRTL1202	12X9	R1/4"	10	33	19	15	12
	IMOPVRTL1203		R3/8"	11	33	19	15	14
	IMOPVRTL1204		R1/2"	15	33	19	15	15

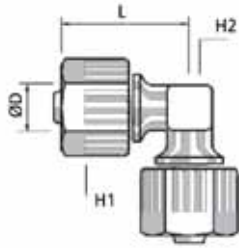

"T" unión • Union tee

IMOPVRT	REFERENCIA	ØD O.D./I.D.	L	H1 (Hex)	H2 (Hex)	Peso Weight(g)
	IMOPVRT06	6X4	22	14	8	7
	IMOPVRT08	8X5,5	22	14	8	5
	IMOPVRT12	12X9	32	19	14	14



Tuerca de cierre • Lock nut

IMOTUBPPR	REFERENCIA	ØD O.D./I.D.	ØC	H2 (Hex)	Peso Weight(g)
	IMOTUBPPR06	6X4	6,2	14	1
	IMOTUBPPR08	8X5,5	8,1	14	2
	IMOTUBPPR10	10X7	10,2	17	3
	IMOTUBPPR12	12X9	12,8	19	4

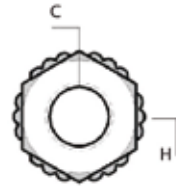

Designación de la referencia - Model designation

IMORC	05	01																																																			
Código Code	Diámetro Tubo Tube diameter	Rosca Thread size																																																			
	<table border="1"> <thead> <tr> <th>Código</th> <th>O.D.</th> <th>I.D.</th> </tr> </thead> <tr><td>05</td><td>5mm</td><td>3mm</td></tr> <tr><td>06</td><td>6mm</td><td>4mm</td></tr> <tr><td>08</td><td>8mm</td><td>6mm</td></tr> <tr><td>10</td><td>10mm</td><td>8mm</td></tr> <tr><td>12</td><td>12mm</td><td>10mm</td></tr> <tr><td>15</td><td>15mm</td><td>12,5mm</td></tr> </table>	Código	O.D.	I.D.	05	5mm	3mm	06	6mm	4mm	08	8mm	6mm	10	10mm	8mm	12	12mm	10mm	15	15mm	12,5mm	<table border="1"> <thead> <tr> <th colspan="2">Métrica Metric thread</th> </tr> </thead> <tr><td>M5</td><td>M5</td></tr> <tr><td>M6</td><td>M6</td></tr> <tr><td>M121</td><td>M12x1,25</td></tr> <tr><td>M122</td><td>M12x1,5</td></tr> </table> <table border="1"> <thead> <tr> <th colspan="2">Cónica BSPT BSPT thread</th> </tr> </thead> <tr><td>01</td><td>R1/8"</td></tr> <tr><td>02</td><td>R1/4"</td></tr> <tr><td>03</td><td>R3/8"</td></tr> <tr><td>04</td><td>R1/2"</td></tr> </table> <table border="1"> <thead> <tr> <th colspan="2">Cilíndrica BSPP BSPP thread</th> </tr> </thead> <tr><td>01</td><td>G1/8"</td></tr> <tr><td>02</td><td>G1/4"</td></tr> <tr><td>03</td><td>G3/8"</td></tr> <tr><td>04</td><td>G1/2"</td></tr> </table>	Métrica Metric thread		M5	M5	M6	M6	M121	M12x1,25	M122	M12x1,5	Cónica BSPT BSPT thread		01	R1/8"	02	R1/4"	03	R3/8"	04	R1/2"	Cilíndrica BSPP BSPP thread		01	G1/8"	02	G1/4"	03	G3/8"	04	G1/2"
Código	O.D.	I.D.																																																			
05	5mm	3mm																																																			
06	6mm	4mm																																																			
08	8mm	6mm																																																			
10	10mm	8mm																																																			
12	12mm	10mm																																																			
15	15mm	12,5mm																																																			
Métrica Metric thread																																																					
M5	M5																																																				
M6	M6																																																				
M121	M12x1,25																																																				
M122	M12x1,5																																																				
Cónica BSPT BSPT thread																																																					
01	R1/8"																																																				
02	R1/4"																																																				
03	R3/8"																																																				
04	R1/2"																																																				
Cilíndrica BSPP BSPP thread																																																					
01	G1/8"																																																				
02	G1/4"																																																				
03	G3/8"																																																				
04	G1/2"																																																				

Datos Técnicos	
Aplicaciones	Sistemas hidráulicos y neumáticos
Materiales utilizados	Latón UNI EN 12164 CW 614N
	Latón UNI EN 12165 CW 617N
	Junta tórica: NBR
Rosca	Gas cónica BSPT ISO 7
	Gas cilíndrica BSPP ISO 228 de 1/8" a 1/2"
	Métrica ISO R/262
Presión de trabajo	18 Bar
Temperatura de trabajo	-20°C +90°C
	-10°C +80°C (para racores orientables)
La presión máxima de trabajo y la temperatura se determina por las características del tubo empleado	
Tubos utilizados	Poliuretano (PU)
	Polietileno (PE)
	Poliamida (PA)
	PTFE calibrado
Producto conforme a la directiva 2002/95/EC RoHS	

Technical specifications	
Applications	Pneumatic and hydraulic systems
Materials used	Brass UNI EN 12164 CW 614N
	Brass UNI EN 12165 CW 617N
	O'Ring: NBR
Threads	Taper gas BSPT ISO 7
	Cylindrical gas BSPP ISO 228 from 1/8" to 1/2"
	Metric ISO R/262
Working pressure	18 Bar
Working temperature	-20°C +90°C
	-10°C +80°C (for swivel fittings)
The working pressure & working temperature depend on the features of the selected tube	
Tubes used	Polyurethane (PU)
	Polyethylene (PE)
	Polyamide (PA)
	Calibrated PTFE
Products in conformity with the directive 2002/95/EC RoHS	

Racor directo rosca hembra cilíndrica BSPP • Female connector BSPP thread

IMORRCH	REFERENCIA	T	Ø D O.D./ I.D.	I	L	H1 (Hex)	H2 (Hex)	Peso Weight(g)
	IMORRCH0501	G1/8"	5x3	8	22,5	14	8	12
	IMORRCH0601	G1/8"	6x4	8	25	14	12	18
	IMORRCH0602	G1/4"		11	29	17	12	26
	IMORRCH0603	G3/8"	8x6	11,5	29,5	20	12	30
	IMORRCH0801	G1/8"		8	25	14	14	20
	IMORRCH0802	G1/4"		11	29	17	14	28
	IMORRCH0803	G3/8"	10x8	11,5	29,5	20	14	32
	IMORRCH1001	G1/8"		8	26,5	14	16	24
	IMORRCH1002	G1/4"		11	30,5	17	16	32
	IMORRCH1003	G3/8"		11,5	31	20	16	36
	IMORRCH1004	G1/2"	12x10	14	34,5	24	16	50
	IMORRCH1203	G3/8"		11,5	32,5	20	18	40

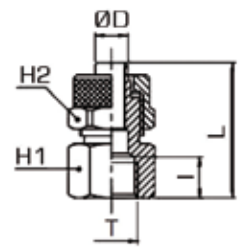

Racor directo rosca macho cónica BSPT • Male connector BSPT thread

IMORRC	REFERENCIA	T	Ø D O.D./ I.D.	I	L	H1 (Hex)	H2 (Hex)	Peso Weight(g)
	IMORRC0501	R 1/8"	5x3	8	25	12	8	10
	IMORRC0601	R 1/8"	6X4	8	27,5	12	12	16
	IMORRC0602	R 1/4"		11	31	14	12	20
	IMORRC0603	R 3/8"		11,5	31,5	17	12	26
	IMORRC0801	R 1/8"	8x6	8	27,5	12	14	18
	IMORRC0802	R 1/4"		11	31	14	14	22
	IMORRC0803	R 3/8"		11,5	31,5	17	14	28
	IMORRC0804	R 1/2"		14	34,5	22	14	44
	IMORRC1001	R 1/8"	10x8	8	29,5	14	16	24
	IMORRC1002	R 1/4"		11	32,5	14	16	28
	IMORRC1003	R 3/8"		11,5	33	17	16	34
	IMORRC1004	R 1/2"		14	36	22	16	46
	IMORRC1203	R 3/8"	12x10	11,5	34,5	17	18	38
	IMORRC1204	R 1/2"		14	37,5	22	18	50
	IMORRC1504	R 1/2"	15x12,5	14	39,5	22	22	62

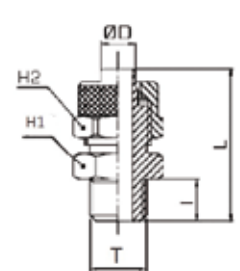

Racor directo rosca macho métrica • Male connector metric thread

IMORRC-M	REFERENCIA	T	Ø D O.D./ I.D.	I	L	H1 (Hex)	H2 (Hex)	Peso Weight(g)
	IMORRC05M5	M5	5X3	4	20	8	8	4
	IMORRC05M6	M6		5	21	8	8	6
	IMORRC06M5	M5		4	21	8	9	6
	IMORRC06M6	M6	6X4	5	22	8	9	6
	IMORRC06M121	M12X1,25		8	28	17	12	22
	IMORRC06M122	M12X1,5	8X6	8	28	17	12	22
	IMORRC08M121	M12X1,25		8	28	17	14	24
	IMORRC08M122	M12X1,5		8	28	17	14	24

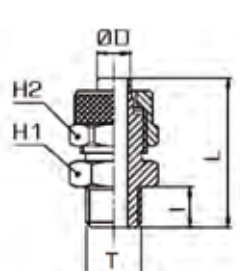

Racor directo rosca macho cilíndrica BSPP con junta • Swivel male connector BSPP thread with OR

IMORRC-G	REFERENCIA	T	Ø D O.D./ I.D.	I	L	H1 (Hex)	H2 (Hex)	H3 (Hex)	Peso Weight(g)
	IMORRC0604-G01	G1/8"	6X4	6	36	12	13	12	24
	IMORRC0604-G02	G1/4"		8	37,5	12	16	14	30
	IMORRC0806-G01	G1/8"	8X6	6	36	14	13	12	26
	IMORRC0806-G02	G1/4"		8	37,5	14	16	14	32
	IMORRC1008-G02	G1/4"	10X8	8	39	16	16	14	38
	IMORRC1210-G03	G3/8"	12X10	9	42	18	19	17	52

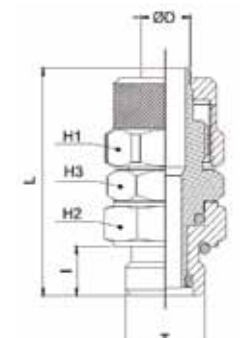

Unión recta tubo - tubo • Union connector

IMORU	REFERENCIA	Ø D		L	H1 (Hex)	H2 (Hex)	H3 (Hex)	Peso Weight(g)
		O.D./ I.D.	O.D./ I.D.					
	IMORU0505	5X3	5X3	28,5	8	8	8	8,0
	IMORU0606	6X4	6X4	34,5	12	12	12	22,0
	IMORU0808	8X6	8X6	35	14	14	14	28,0
	IMORU0806	8X6	6X4	35	14	14	12	26,0
	IMORU1010	10X8	10X8	38	14	16	16	36,0
	IMORU1212	12X10	12X10	41	17	18	18	48,0
	IMORU1515	15X12,5	15X12,5	45,5	22	22	22	78,0

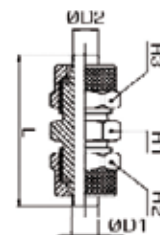

Pasatabiques tubo - tubo • Bulkhead connector

IMORP	REFERENCIA	Ø D		L	A max	H1 (Hex)	H2 (Hex)	Rosca pasatabiques ØP	Peso Weight(g)
		O.D./ I.D.	I.D.						
	IMORP05	5X3		40	8,5	9	8	M6x0,5	12,0
	IMORP06	6X4		48	10,5	14	12	M10x1	34,0
	IMORP08	8X6		48	10,5	16	14	M12x1	42,0
	IMORP10	10X8		50	8,5	17	16	M14x1	54,0
	IMORP12	12X10		53	8,5	19	18	M16x1	76,0
	IMORP15	15X12,5		58	8,5	24	22	M20x1	110,0

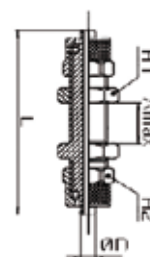

Codo rosca hembra cilíndrica BSPP • Female elbow BSPP thread

IMORCH	REFERENCIA	T	Ø D		I	L1	L2	H1 (Hex)	H2 (Hex)	Peso Weight(g)	
			O.D./ I.D.	I.D.							
	IMORCH0501	G1/8"	5X3		8,0	21,5	19,0	10	8	16,0	
	IMORCH0601	G1/8"			8,0	22,5	19,0	10	12	22,0	
	IMORCH0602	G1/4"	6X4		10,5	25,0	23,0	11	12	36,0	
	IMORCH0801	G1/8"		8X6		8,0	22,5	19,0	10	14	22,0
	IMORCH0802	G1/4"				10,5	25,0	23,0	11	14	32,0
	IMORCH1002	G1/4"		10X8		11,0	26,0	23,5	13	16	38,0
	IMORCH1203	G3/8"		12X10		11,5	30,5	28,0	17	18	60,0

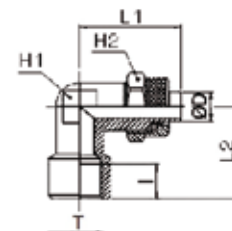

Codo tubo - tubo • Union elbow

IMORC	REFERENCIA	Ø D1 O.D./ I.D.	Ø D2 O.D./ I.D.	L1	L2	H1 (Hex)	H2 (Hex)	H3 (Hex)	Peso Weight(g)
	IMORC0505	5X3	5X3	21,5	21,5	8	8	8	12,0
	IMORC0606	6X4	6X4	21,5	21,5	8	12	12	20,0
	IMORC0808	8X6	8X6	22,5	22,5	10	14	14	28,0
	IMORC0806	8X6	6X4	22,5	22,5	10	14	12	26,0
	IMORC1010	10X8	10X8	25,5	25,5	11	16	16	38,0
	IMORC1212	12X10	12X10	30,0	30,0	14	18	18	56,0
	IMORC1515	15X12,5	15X12,5	34,0	34,0	17	22	22	88,0

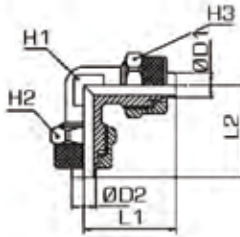

Codo rosca macho cónica BSPT • Male elbow BSPT thread

IMORCM	REFERENCIA	T	Ø D O.D./ I.D.	I	L1	L2	H1 (Hex)	H2 (Hex)	Peso Weight(g)
	IMORCM0501	R1/8"	5X3	8,0	21,5	17,0	8	8	10,0
	IMORCM0601	R1/8"	5X3	8,0	22,5	17,0	8	12	16,0
	IMORCM0602	R1/4"	6X4	11,0	22,5	20,0	10	12	22,0
	IMORCM0603	R3/8"	6X4	11,5	23,5	22,5	11	12	30,0
	IMORCM0801	R1/8"	8X6	8,0	22,5	17,0	10	14	20,0
	IMORCM0802	R1/4"	8X6	11,0	22,5	20,0	10	14	24,0
	IMORCM0803	R3/8"	8X6	11,5	24,0	22,5	11	14	32,0
	IMORCM1001	R1/8"	10X8	8,0	25,5	18,5	11	16	28,0
	IMORCM1002	R1/4"	10X8	11,0	25,5	21,5	11	16	32,0
	IMORCM1003	R3/8"	10X8	11,5	25,5	22,5	11	16	34,0
	IMORCM1004	R1/2"	10X8	14,0	28,0	28,0	17	16	56,0
	IMORCM1202	R1/4"	12X10	11,0	30,0	24,0	14	18	42,0
	IMORCM1203	R3/8"	12X10	11,5	30,0	24,0	14	18	48,0
	IMORCM1204	R1/2"	12X10	14,0	30,5	28,0	17	18	60,0
IMORCM1504	R1/2"	15X12,5	14,0	34	28,0	17	22	70,0	

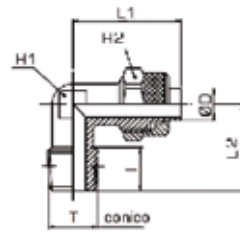

Codo orientable rosca macho cilíndrica BSPP • Swivel male elbow BSPP thread

IMORCMK	REFERENCIA	T	Ø D O.D./ I.D.	I	L1	L2	H1 (Hex)	H2 (Hex)	H3 (Hex)	Peso Weight(g)
	IMORCMK0601	G1/8"	6X4	6	22,5	22,5	8	12	14	22,0
	IMORCMK0602	G1/4"	6X4	8	23,5	25,0	10	12	17	34,0
	IMORCMK0801	G1/8"	8X6	6	23,5	22,5	10	14	14	28,0
	IMORCMK0802	G1/4"	8X6	8	23,5	25,0	10	14	17	36,0
	IMORCMK1002	G1/4"	10X8	8	23,5	25,5	11	14	17	42,0

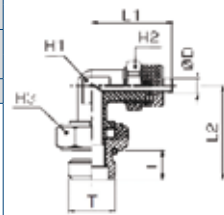

Cruz tubo • Cross junction

IMORZ	REFERENCIA	Ø D O.D./I.D.	L1	L2	H1 (Hex)	H2 (Hex)	Peso Weight(g)
	IMORZ05	5/3	43	43	8	8	22,0
	IMORZ06	6/4	45	45	8	12	42,0
	IMORZ08	8/6	45	45	10	14	52,0
	IMORZ10	10/8	51	51	11	16	70,0

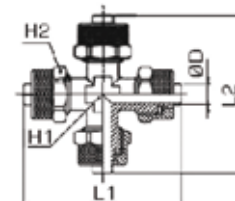

"T" Rosca central macho cónica BSPT • Male tee adapter BSPT thread

IMORTC	REFERENCIA	T	Ø D O.D./ I.D.	I	L1	L2	H1 (Hex)	H2 (Hex)	Peso Weight(g)
	IMORTC05M5	M5	5/3	4,0	43,0	15,0	8	8	16,0
	IMORTC0501	R1/8"		8,0	43,0	17,0	8	8	16,0
	IMORTC0601	R1/8"	6/4	8,0	45,0	17,0	8	12	26,0
	IMORTC0602	R1/4"		11,0	45,5	20,5	10	12	34,0
	IMORTC0603	R3/8"		11,5	47,0	22,5	11	12	42,0
	IMORTC0801	R1/8"	8/6	8,0	45,5	17,5	10	14	34,0
	IMORTC0802	R1/4"		11,0	45,5	20,5	10	14	36,0
	IMORTC0803	R3/8"		11,5	48,0	22,5	11	14	44,0
	IMORTC1001	R1/8"	10/8	8,0	51,0	18,5	11	16	44,0
	IMORTC1002	R1/4"		11,0	51,0	21,5	11	16	48,0
	IMORTC1003	R3/8"		11,5	51,0	22,5	11	16	50,0
	IMORTC1004	R1/2"		14,0	57,0	28,0	17	16	80,0
	IMORTC1203	R3/8"	12/10	11,5	60,0	24,5	14	18	70,0
	IMORTC1204	R1/2"		14,0	61,0	28,0	17	18	86,0
IMORTC1504	R1/2"	15/12,5	14	68	28,0	17	22	108,0	

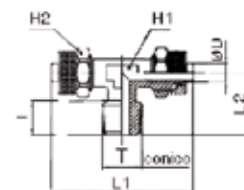

"T" Rosca central macho cilíndrica BSPP • Male tee adapter BSPP thread

IMORTC-G	REFERENCIA	T	Ø D O.D./ I.D.	I	L1	L2	H1 (Hex)	H2 (Hex)	H3 (Hex)	Peso Weight(g)
	IMORTC0604-G01	G1/8"	6/4	6	45	25,7	8	12	13	23
	IMORTC0604-G02	G1/4"		8	45,5	29	10	12	17	35
	IMORTC0806-G01	G1/8"	8/6	6	45,5	26	10	14	13	29
	IMORTC0806-G02	G1/4"		8	45,5	28	10	14	17	37
	IMORTC1008-G02	G1/4"		8	51	29	11	16	17	43

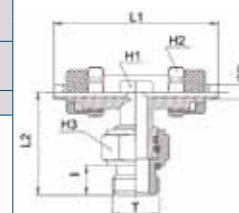

"T" Rosca lateral macho cónica BSPT • Lateral male tee BSPT thread

IMORTL	REFERENCIA	T	Ø D O.D./ I.D.	I	L1	L2	L3	H1 (Hex)	H2 (Hex)	Peso Weight(g)
	IMORTL05M5	M5	5/3	4,0	21,5	36,5	15,0	8	8	16,0
	IMORTL0501	R1/8"		8,0	21,5	38,5	17,0	8	8	16,0
	IMORTL0601	R1/8"	6/4	8,0	22,5	39,5	17,0	8	12	26,0
	IMORTL0602	R1/4"		11,0	22,5	42,5	20,0	10	12	34,0
	IMORTL0603	R3/8"		11,5	24,0	46,5	22,5	11	12	40,0
	IMORTL0801	R1/8"	8/6	8,0	22,5	40,5	17,5	10	14	34,0
	IMORTL0802	R1/4"		11,0	22,5	43,5	20,5	10	14	38,0
	IMORTL0803	R3/8"		11,5	23,5	46,5	22,5	11	14	44,0
	IMORTL1001	R1/8"	10/8	8,0	25,5	44,0	18,5	11	16	44,0
	IMORTL1002	R1/4"		11,0	25,5	46,5	21,0	11	16	48,0
	IMORTL1003	R3/8"		11,5	25,5	48,0	22,5	11	16	50,0
	IMORTL1004	R1/2"	12/10	14,0	29,0	57,0	28,0	17	16	76,0
	IMORTL1203	R3/8"		11,5	30,0	54,5	24,5	14	18	70,0
	IMORTL1204	R1/2"		14,0	30,5	58,5	28,0	17	18	86,0
IMORTL1504	R1/2"	15/12,5	14,0	34,0	62,0	28,0	17	22	108,0	

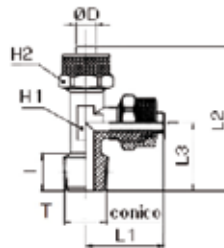

"T" Tubo • Union tee

IMORT	REFERENCIA	Ø D1 O.D./ I.D.	Ø D2 O.D./ I.D.	L1	L2	H1 (Hex)	H2 (Hex)	H3 (Hex)	Peso Weight(g)
	IMORT0505	5/3	5/3	43,0	21,5	8	8	8	16,0
	IMORT0606	6/4	6/4	45,0	22,5	8	12	12	32,0
	IMORT0808	8/6	8/6	45,0	22,5	10	14	14	42,0
	IMORT0806	8/6	6/4	45,0	22,5	10	14	12	40,0
	IMORT1010	10/8	10/8	51,0	25,5	11	16	16	56,0
	IMORT1212	12/10	12/10	60,0	30,0	14	18	18	78,0
	IMORT1515	15/12,5	15/12,5	68,0	34,0	17	22	22	124,0

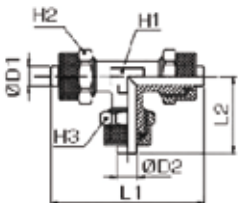

Tuerca de cierre • Lock out

IMORTUBI	REFERENCIA	T	Ø D O.D./I.D.	I	L	H (Hex)	Peso Weight(g)
	IMORTUBI0503	M7x0,75	5/3	6	8,5	8	1,34
	IMORTUBI0604	M10x1	6/4	7,5	10,5	12	4,64
	IMORTUBI0806	M12x1	8/6	7,5	10,5	14	5,57
	IMORTUBI1008	M14x1	10/8	8	11,5	16	7,09
	IMORTUBI1210	M16x1	12/10	10	13	18	9,36
	IMORTUBI15125	M20x1	15/12,5	11	15,5	22	15,04

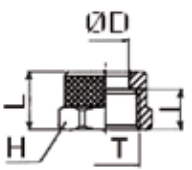

Designación de la referencia - Model designation

IMORC	06	01	X																																		
Código Code	Diámetro Tubo Tube diameter	Rosca Thread size	Acero INOX AISI 316 Stainles steel AISI 316																																		
	<table border="1"> <thead> <tr> <th>Código</th> <th>O.D.</th> <th>I.D.</th> </tr> </thead> <tbody> <tr> <td>06</td> <td>6mm</td> <td>4mm</td> </tr> <tr> <td>08</td> <td>8mm</td> <td>6mm</td> </tr> <tr> <td>10</td> <td>10mm</td> <td>8mm</td> </tr> <tr> <td>12</td> <td>12mm</td> <td>10mm</td> </tr> </tbody> </table>	Código	O.D.	I.D.	06	6mm	4mm	08	8mm	6mm	10	10mm	8mm	12	12mm	10mm	<table border="1"> <thead> <tr> <th colspan="2">Cónica BSPT BSPT thread</th> </tr> </thead> <tbody> <tr> <td>01</td> <td>R1/8"</td> </tr> <tr> <td>02</td> <td>R1/4"</td> </tr> <tr> <td>03</td> <td>R3/8"</td> </tr> <tr> <td>04</td> <td>R1/2"</td> </tr> </tbody> </table> <table border="1"> <thead> <tr> <th colspan="2">Cilíndrica BSPP BSPP thread</th> </tr> </thead> <tbody> <tr> <td>01</td> <td>G1/8"</td> </tr> <tr> <td>02</td> <td>G1/4"</td> </tr> <tr> <td>03</td> <td>G3/8"</td> </tr> <tr> <td>04</td> <td>G1/2"</td> </tr> </tbody> </table>	Cónica BSPT BSPT thread		01	R1/8"	02	R1/4"	03	R3/8"	04	R1/2"	Cilíndrica BSPP BSPP thread		01	G1/8"	02	G1/4"	03	G3/8"	04	G1/2"
Código	O.D.	I.D.																																			
06	6mm	4mm																																			
08	8mm	6mm																																			
10	10mm	8mm																																			
12	12mm	10mm																																			
Cónica BSPT BSPT thread																																					
01	R1/8"																																				
02	R1/4"																																				
03	R3/8"																																				
04	R1/2"																																				
Cilíndrica BSPP BSPP thread																																					
01	G1/8"																																				
02	G1/4"																																				
03	G3/8"																																				
04	G1/2"																																				

Datos Técnicos	
Aplicaciones	Circuitos neumáticos e hidráulicos. Industrias química, alimentaria, medicinal y farmacéutica
Materiales utilizados	Cuerpo: acero INOX AISI 316
	Tuerca: acero INOX AISI 316
	Junta tórica para racor giratorio: FKM
Rosca	Gas cónica BSPT DIN 3858 de 1/8" a 1/2"
	Gas cilíndrica BSPP ISO 228 (DIN 259) de 1/8" a 1/2"
Presión de trabajo	25 bar (PN 25) a 20 °C
Temperatura de trabajo	De -40°C a +180°C
	De -20°C a +120°C (para racores giratorios)
Tubos utilizados	Polietileno (PE)
	Fluoropolímero FEP
	PTF calibrado
Características	Los racores de esta serie están totalmente fabricados en AISI 316 y están indicados para contacto con alimentos y productos químicos.
Producto conforme a la directiva 2002/95/EC 	

Technical specifications	
Applications	Pneumatic and hydraulic systems, food chemical, medical and pharmaceutical applications
Materials used	Body: stainless steel AISI 316
	Nut: stainless steel AISI 316
	O'ring for swivel fittings: FKM
Threads	Taper gas BSPT DIN 3858 from 1/8" to 1/2"
	Cylindrical gas BSPP ISO 228 (DIN 259) from 1/8" to 1/2"
Working pressure	25 BAR (PN 25) at 20 °C
Working temperature	From -40°C to +180°C
	From -20°C to +120°C for swivel fittings
Tubes used	Polyethylene (PE)
	Calibrated PTFE
	Fluoropolymer FEP
Advantages	The fittings of these range, completely in AISI 316, are also suitable for food and chemical liquids
Products in conformity with the directive 2002/95/EC 	

Racor directo rosca macho cónica BSPT • Male connector BSPT thread

IMORRCX	REFERENCIA	T	Ø D O.D./ I.D.	I	L1	D1	H1 (Hex)	H2 (Hex)	Peso Weight(g)
	IMORRC0601X	R 1/8"	6X4	7,5	26	13	12	12	14
	IMORRC0602X	R 1/4"		11	30	13	14	12	21
	IMORRC0801X	R 1/8"	8x6	7,5	26	15,5	12	14	17
	IMORRC0802X	R 1/4"		11	30	15,5	14	14	24
	IMORRC1001X	R 1/8"	10x8	7,5	28	18,5	14	17	28
	IMORRC1002X	R 1/4"		11	32	18,5	14	17	30
	IMORRC1003X	R 3/8"		11,5	32	18,5	17	17	40
	IMORRC1203X	R 3/8"		11,5	34	21	17	19	34
IMORRC1204X	R 1/2"	14	37	21	22	19	34		

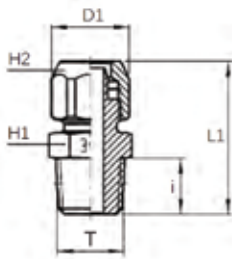

Racor directo rosca macho cilíndrica BSPB • Male connector BSPB thread

IMORRC-GX	REFERENCIA	T	Ø D O.D./ I.D.	I	L1	D1	H1 (Hex)	H2 (Hex)	Peso Weight(g)
	IMORRC06-G01X	G1/8"	6X4	8	18,5	13	13	12	15
	IMORRC06-G02X	G1/4"		10	19	13	17	12	24
	IMORRC08-G01X	G1/8"	8x6	8	18,5	15,5	13	14	18
	IMORRC08-G02X	G1/4"		10	19	15,5	17	14	27
	IMORRC10-G01X	G1/8"	10x8	8	20	18,5	14	17	28
	IMORRC10-G02X	G1/4"		10	20,5	18,5	17	17	32
	IMORRC10-G03X	G3/8"		10	20,5	18,5	19	17	40
	IMORRC12-G03X	G3/8"		10	22	21	19	19	34
IMORRC12-G04X	G1/2"	12	22,5	21	24	19	34		

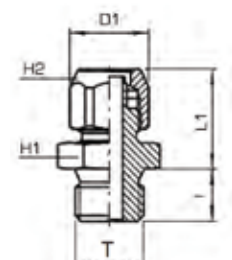

Codo rosca macho cónica BSPT • Male connector BSPT thread

IMORCMX	REFERENCIA	T	Ø D O.D./ I.D.	I	L1	L2	D1	H1 (Hex)	H2 (Hex)	Peso Weight(g)
	IMORCM0601X	R1/8"	6X4	9	22,5	18,5	13	10	12	19
	IMORCM0602X	R1/4"		11	22,5	21	13	10	12	22
	IMORCM0801X	R1/8"	8x6	9	22,5	18,5	15,5	10	14	20
	IMORCM0802X	R1/4"		11	22,5	21	15,5	10	14	23
	IMORCM0803X	R3/8"	11,5	26,5	25	15,5	13	14	40	
	IMORCM1001X	R1/8"	10x8	9	25	18,5	18,5	10	17	26
	IMORCM1002X	R1/4"		11	25	21	18,5	10	17	28
	IMORCM1003X	R3/8"		11,5	27	25	18,5	13	17	20
	IMORCM1203X	R3/8"		11,5	29	25	21	13	19	40
	IMORCM1204X	R1/2"	14	30,5	29	21	17	19	40	

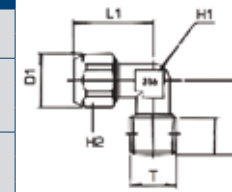



Codo orientable rosca macho cónica BSPT • Swivel male connector BSPT thread

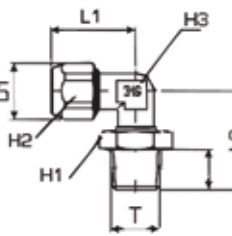

IMORCMKX	REFERENCIA	T	Ø D O.D./ I.D.	I	L1	L2	D1	H1 (Hex)	H2 (Hex)	H3 (Hex)	Peso Weight(g)
	IMORCMK0601X	R1/8"	6X4	7,5	22,5	21,5	13	13	12	10	24
	IMORCMK0602X	R1/4"		11	22,5	25,5	13	17	12	10	28
	IMORCMK0801X	R1/8"	8x6	7,5	22,5	21,5	15	13	14	10	25
	IMORCMK0802X	R1/4"		11	22,5	25,5	15	17	14	10	30
	IMORCMK1002X	R1/4"	10x8	11	22,5	25,5	18,5	17	17	10	36

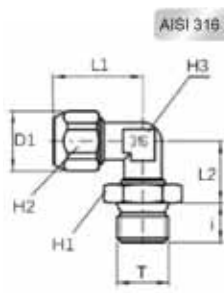

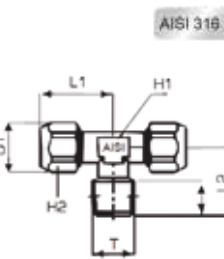

Codo orientable rosca macho cilíndrica BSPP • Swivel male elbow BSPP thread

IMORCMK-GX	REFERENCIA	T	Ø D O.D./ I.D.	I	L1	L2	D1	H1 (Hex)	H2 (Hex)	H3 (Hex)	Peso Weight(g)	
	IMORCMK06-G01X	G1/8"	6X4	8	22,5	14	13	13	12	10	24	
	IMORCMK06-G02X	G1/4"		10	22,5	14,5	13	17	12	10	24	
	IMORCMK08-G01X	G1/8"	8x6	8	22,5	14	15,5	13	14	10	25	
	IMORCMK08-G02X	G1/4"		10	22,5	14,5	15,5	17	14	10	29	
	IMORCMK10-G02X	G1/4"	10x8	10	23,5	14,5	18,5	17	17	10	35	

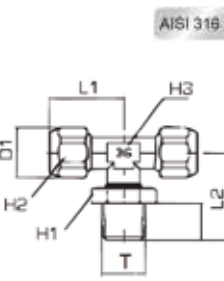

"T" rosca central macho cónica BSPT • Male tee BSPT thread

IMORTCX	REFERENCIA	T	Ø D O.D./ I.D.	I	L1	L2	D1	H1 (Hex)	H2 (Hex)	Peso Weight(g)	
	IMORTC0601X	R1/8"	6X4	9	22,5	18,5	13	10	12	36	
	IMORTC0602X	R1/4"		11	22,5	21	13	10	12	74	
	IMORTC0801X	R1/8"	8x6	9	22,5	18,5	15,5	10	14	31	
	IMORTC0802X	R1/4"		11	22,5	21	15,5	10	14	36	
	IMORTC1001X	R1/8"	10x8	9	25	18,5	18,5	10	17	36	
	IMORTC1002X	R1/4"		11	25	21	18,5	10	17	74	
	IMORTC1003X	R3/8"		11,5	27	25	18,5	13	17	70	
	IMORTC1203X	R3/8"	12x10	11,5	29	25	21,0	13	19	74	
IMORTC1204X	R1/2"	14		32,5	29	21,0	17	19	74		

"T" orientable rosca central macho cónica BSPT • Swivel male tee BSPT thread

IMORTCKX	REFERENCIA	T	Ø D O.D./ I.D.	I	L1	L2	D1	H1 (Hex)	H2 (Hex)	H3 (Hex)	Peso Weight(g)	
	IMORTCK0601X	R1/8"	6X4	7,5	22,5	21,5	13	13	12	10	35	
	IMORTCK0602X	R1/4"		11	22,5	25,5	13	14	12	10	39	
	IMORTCK0801X	R1/8"	8x6	7,5	22,5	21,5	15	13	14	10	38	
	IMORTCK0802X	R1/4"		11,0	22,5	25,5	15	14	14	10	42	
	IMORTCK1002X	R1/4"	10x8	11,0	25,0	25,5	18,5	14	17	10	40	

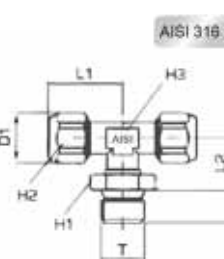
"T" orientable rosca central macho cilíndrica BSPP • Swivel male tee BSPP thread

IMORTCK-GX	REFERENCIA	T	Ø D O.D./ I.D.	I	L1	L2	D1	H1 (Hex)	H2 (Hex)	H3 (Hex)	Peso Weight(g)	
	IMORTCK06-G01X	G1/8"	6X4	8,0	22,5	14,0	13	13	12	10	36	
	IMORTCK06-G02X	G1/4"		10	22,5	14,5	13	17	12	10	38	
	IMORTCK08-G01X	G1/8"	8x6	8	22,5	14	15	13	14	10	37	
	IMORTCK08-G02X	G1/4"		10	22,5	14,5	15	17	14	10	41	
	IMORTCK10-G02X	G1/4"	10x8	10	23,5	14,5	18,5	17	17	10	54	

"T" rosca lateral macho cónica BSPT • Lateral male tee BSPT thread

IMORTLX	REFERENCIA	T	Ø D O.D./ I.D.	I	L1	L2	L3	D1	H1 (Hex)	H2 (Hex)	Peso Weight(g)
	IMORTL0601X	R1/8"	6X4	9,0	41,0	22,5	19	13	10	12	35
	IMORTL0602X	R1/4"		10,5	43,5	22,5	21	13	10	12	40
	IMORTL0801X	R1/8"	8x6	9,0	41,0	22,5	19	15	10	14	35
	IMORTL0802X	R1/4"		10,5	43,5	22,5	21	15	10	14	35
	IMORTL1001X	R1/8"	10x8	9,0	43,5	25	19	18,5	10	17	35
	IMORTL1002X	R1/4"		10,5	46	25	21	18,5	10	17	40
IMORTL1003X	R3/8"	11,5		54	29	25	18,5	13	17	70	

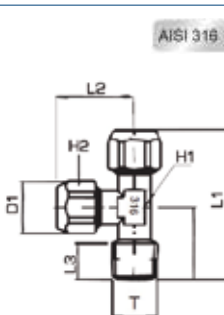

Codo tubo - tubo • Union elbow

IMORCX	REFERENCIA	Ø DA O.D./ I.D.	Ø DB O.D./ I.D.	L	D1	H1 (Hex)	H2 (Hex)	Peso Weight(g)
	IMORC0606X	6X4	6X4	22,5	13,0	10	12	29
	IMORC0808X	8x6	8x6	22,5	13,5	10	12	29
	IMORC1010X	10x8	10x8	25,0	15,5	10	13	70
	IMORC1212X	12x10	12x10	29,0	21,0	13	19	40

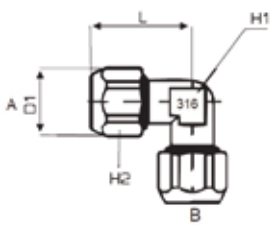

"T" tubo • Union tee

IMORTX	REFERENCIA	Ø DA O.D./ I.D.	Ø DB O.D./ I.D.	L	D1	H1 (Hex)	H2 (Hex)	Peso Weight(g)
	IMORT0606X	6X4	6X4	22,5	13,0	10	12	26
	IMORT0808X	8x6	8x6	22,5	13,5	10	14	38
	IMORT1010X	10x8	10x8	25,0	15,5	10	17	29
	IMORT1212X	12x10	12x10	29,0	21,0	13	19	29

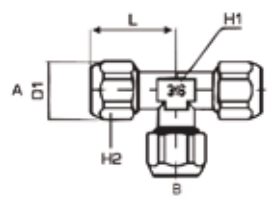

Tuerca de cierre • Lock nut

TMM	REFERENCIA	T	Ø D O.D./ I.D.	L	I	D1	H (Hex)	Peso Weight(g)
	TM6M101-316	M10x1	6X4	11,5	6	13,1	12	5
	TM8M121-316	M12x1	8x6	11,5	6	15,3	14	6
	TM10M141-316	M14x1	10x8	13,5	6,5	18,5	17	13
	TM12M161-316	M16x1	12x10	14,5	6,5	21,0	19	15

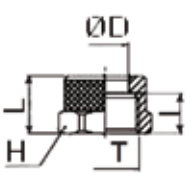

Designación de la referencia - Model designation

IMOBRC	04	01																																								
Código Code	Diámetro Tubo Tube diameter	Rosca Thread size																																								
	<table border="1"> <tr><th>Código</th><th>O.D.</th></tr> <tr><td>04</td><td>4mm</td></tr> <tr><td>06</td><td>6mm</td></tr> <tr><td>08</td><td>8mm</td></tr> <tr><td>10</td><td>10mm</td></tr> <tr><td>12</td><td>12mm</td></tr> <tr><td>14</td><td>14mm</td></tr> <tr><td>15</td><td>15mm</td></tr> <tr><td>16</td><td>16mm</td></tr> <tr><td>18</td><td>18mm</td></tr> </table>	Código	O.D.	04	4mm	06	6mm	08	8mm	10	10mm	12	12mm	14	14mm	15	15mm	16	16mm	18	18mm	<table border="1"> <tr><th colspan="2">Cónica BSPT BSPT thread</th></tr> <tr><td>01</td><td>R1/8"</td></tr> <tr><td>02</td><td>R1/4"</td></tr> <tr><td>03</td><td>R3/8"</td></tr> <tr><td>04</td><td>R1/2"</td></tr> <tr><th colspan="2">Cilíndrica BSPP BSPP thread</th></tr> <tr><td>01</td><td>G1/8"</td></tr> <tr><td>02</td><td>G1/4"</td></tr> <tr><td>03</td><td>G3/8"</td></tr> <tr><td>04</td><td>G1/2"</td></tr> </table>	Cónica BSPT BSPT thread		01	R1/8"	02	R1/4"	03	R3/8"	04	R1/2"	Cilíndrica BSPP BSPP thread		01	G1/8"	02	G1/4"	03	G3/8"	04	G1/2"
Código	O.D.																																									
04	4mm																																									
06	6mm																																									
08	8mm																																									
10	10mm																																									
12	12mm																																									
14	14mm																																									
15	15mm																																									
16	16mm																																									
18	18mm																																									
Cónica BSPT BSPT thread																																										
01	R1/8"																																									
02	R1/4"																																									
03	R3/8"																																									
04	R1/2"																																									
Cilíndrica BSPP BSPP thread																																										
01	G1/8"																																									
02	G1/4"																																									
03	G3/8"																																									
04	G1/2"																																									

Datos Técnicos	
Aplicaciones	Sistemas neumáticos e hidráulicos Los asientos del racor, biconos y tuercas están fabricados de acuerdo a la norma DIN 3870-3861
Materiales utilizados	Latón UNI EN 12164 CW 614N Latón UNI EN 12165 CW 617N
Tratamiento superficial	Niquelado
Roscas	Gas cónica BSPT ISO 7 DIN 2999 BS 21 de 1/8" a 1/2" Gas cilíndrica BSPP ISO 228 de 1/8" a 1/2"
Presión de trabajo	60 Bar
Temperatura de trabajo	De -20°C a +90°C La presión máxima de trabajo y la temperatura dependerán del tubo utilizado
Tubos utilizados	Tubo metálico: latón, cobre, acero y aluminio Tubo en plástico solo con refuerzo interior (nuestra referencia REFBI) Poliamida (PA)
Producto conforme a la directiva 2002/95/EC 	

Technical specifications	
Applications	Pneumatic and hydraulic systems seats of pipe fittings, ogives and screw nuts are manufactured in compliance with DIN 3870 - 3861
Materials used	Brass UNI EN 12164 CW 614N Brass UNI EN 12165 CW 617N
Surface treatment	nickel plating
Threads	Taper gas BSPT ISO 7 DIN 2999 BS 21 from 1/8" to 1/2" Cylindrical gas BSPP ISO 228 from 1/8" to 1/2"
Working pressure	60 BAR
Working temperature	From -20°C to +90°C The working pressure & working temperatura depend on the features of the selected tube
Tubes used	Metal tubes: brass, copper, steel, aluminum Plastic tubes only internally reinforced (our item REFBI) Polyamide (PA)
Products in conformity with the directive 2002/95/EC 	

Racor directo rosca macho cónica BSPT • Male connector BSPT thread

IMOBRC	REFERENCIA	T	Ø D	I	L	H1 (Hex)	H2 (Hex)	Peso Weight(g)
	IMOBRC0401	R1/8"	4	8	27	10	10	12
	IMOBRC0601	R1/8"	6	8	28	12	12	16
	IMOBRC0602	R1/4"		11	32,5	14	12	24
	IMOBRC0801	R1/8"	8	8	29,5	12	14	18
	IMOBRC0802	R1/4"		11	33	14	14	24
	IMOBRC0803	R3/8"		11,5	33	17	14	36
	IMOBRC1002	R1/4"	10	11	37,5	17	19	44
	IMOBRC1003	R3/8"		11,5	38	17	19	50
	IMOBRC1004	R1/2"		14	40,5	22	19	74
	IMOBRC1203	R3/8"		11,5	39	19	22	58
	IMOBRC1204	R1/2"	12	14	41	22	22	78
	IMOBRC1404	R1/2"		14	42,5	22	27	102
	IMOBRC1504	R1/2"	15	14	42,5	22	27	96
	IMOBRC1604	R1/2"	16	14	42	24	30	112
IMOBRC1804	R1/2"	18	14	43	26	32	126	

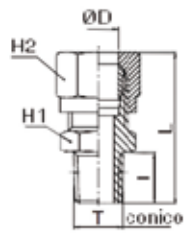

Codo rosca macho cónica BSPT • Male elbow BSPT thread

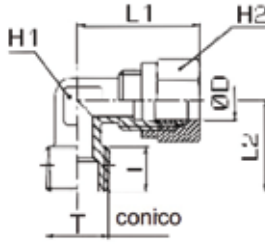
IMOBL	REFERENCIA	T	Ø D	I	L1	L2	H1 (Hex)	H2 (Hex)	Peso Weight(g)
	IMOBL0401	R1/8"	4	8	21	16	9	10	14
	IMOBL0601	R1/8"	6	8	22	16	9	12	16
	IMOBL0602	R1/4"		11	24,5	20	11	12	24
	IMOBL0801	R1/8"	8	8	24	17	11	14	22
	IMOBL0802	R1/4"		11	24	20	11	14	26
	IMOBL0803	R3/8"		11,5	27	24	13	14	36
	IMOBL1002	R1/4"	10	11	32	23,5	13	19	48
	IMOBL1003	R3/8"		11,5	32	24	13	19	52
	IMOBL1004	R1/2"		14	34	28,5	15	19	66
	IMOBL1203	R3/8"		11,5	34,5	25,5	15	22	69
	IMOBL1204	R1/2"	12	14	34,5	28,5	15	22	74
	IMOBL1404	R1/2"		14	38	30	17	27	106
	IMOBL1504	R1/2"	15	14	38	30	17	27	100
	IMOBL1604	R1/2"	16	14	39,5	31,5	19	30	124
IMOBL1804	R1/2"	18	14	44	34	22	32	156	

Codo rosca hembra cilíndrica BSPP • Female elbow BSPP thread

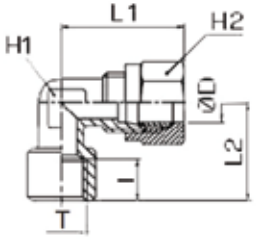
IMOBLH	REFERENCIA	T	Ø D	I	L1	L2	H1 (Hex)	H2 (Hex)	Peso Weight(g)
	IMOBLH0401	G1/8"	4	8	22	20	9	10	18
	IMOBLH0601	G1/8"	6	8	24	20	9	12	20
	IMOBLH0602	G1/4"		11	27	25,5	13	12	39
	IMOBLH0801	G1/8"	8	8	24	20	11	14	26
	IMOBLH0802	G1/4"		11	27,5	25,5	13	14	40

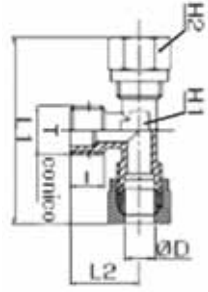

"T" Rosca macho central cónica BSPT • Male tee BSPT thread

IMOBT	REFERENCIA	T	Ø D	I	L1	L2	H1 (Hex)	H2 (Hex)	Peso Weight(g)
	IMOBT0401	R1/8"	4	8	42	16	9	10	22
	IMOBT0601	R1/8"	6	8	46	16	9	12	26
	IMOBT0602	R1/4"		11	48	20	11	12	34
	IMOBT0801	R1/8"	8	8	48	17	11	14	34
	IMOBT0802	R1/4"		11	48	20	11	14	38
	IMOBT0803	R3/8"		11,5	54	24	13	14	52
	IMOBT1002	R1/4"	10	11	64	23,5	13	19	80
	IMOBT1003	R3/8"		11,5	64	24	13	19	84
	IMOBT1203	R3/8"		11,5	69	25,5	15	22	108
	IMOBT1204	R1/2"		14	69	28,5	15	22	118
	IMOBT1404	R1/2"	14	14	76	30	17	27	176
	IMOBT1504	R1/2"	15	14	76	30	17	27	170
	IMOBT1604	R1/2"	16	14	79	31,5	19	30	212
	IMOBT1804	R1/2"	18	14	88	34	22	32	256

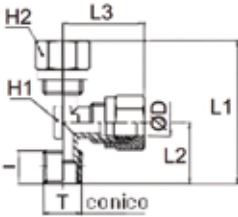

"T" Rosca lateral macho cónica BSPT • Lateral male tee BSPT thread

IMOBST	REFERENCIA	T	Ø D	I	L1	L2	L3	H1 (Hex)	H2 (Hex)	Peso Weight(g)
	IMOBST0401	R1/8"	4	8	37	16	21	9	10	22
	IMOBST0601	R1/8"	6	8	39	16	23	9	10	26
	IMOBST0602	R1/4"	6	11	44,5	20	24,5	11	12	34
	IMOBST0801	R1/8"	8	8	41	17	24	11	14	34
	IMOBST0802	R1/4"	8	11	44	20	24	11	14	38
	IMOBST0803	R3/8"	8	11,5	51	24	27	13	14	52
	IMOBST1002	R1/4"	10	11	55,5	23,5	32	13	19	80
	IMOBST1003	R3/8"	10	11,5	56	24	32	13	19	84
	IMOBST1203	R3/8"	12	11,5	60	25,5	34,5	15	22	110
	IMOBST1204	R1/2"	12	14	63	28,5	34,5	15	22	118
	IMOBST1404	R1/2"	14	14	68	30	38	17	27	176
	IMOBST1504	R1/2"	15	14	68	30	38	17	27	170
	IMOBST1604	R1/2"	16	14	71	31,5	39,5	19	30	210
IMOBST1804	R1/2"	18	14	78	34	44	22	32	256	



Unión recta tubo - tubo • Union connector

IMOBUC	REFERENCIA	Ø D	L	H1 (Hex)	H2 (Hex)	Peso Weight(g)
	IMOBUC04	4	33,5	10	10	16
	IMOBUC06	6	36,5	12	12	25
	IMOBUC08	8	38,5	14	14	28
	IMOBUC10	10	47,5	17	19	66
	IMOBUC12	12	50,5	19	22	93
	IMOBUC14	14	55,5	24	27	148
	IMOBUC15	15	55,5	24	27	140
	IMOBUC16	16	58	24	30	177
	IMOBUC18	18	60	26	32	198

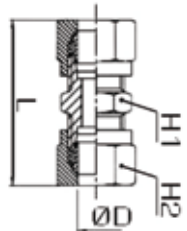

Pasatabiques tubo - tubo • Bulkhead connector

IMOBMM	REFERENCIA	Ø D	A max	L	H1 (Hex)	H2 (Hex)	Peso Weight(g)
	IMOBMM06	6	15,5	51,5	14	12	32
	IMOBMM08	8	16,5	55,5	16	14	42
	IMOBMM10	10	15,5	62,5	19	19	90
	IMOBMM12	12	16	64,5	22	22	116
	IMOBMM14	14	18	69,5	25	27	192
	IMOBMM15	15	18	69,5	25	27	184

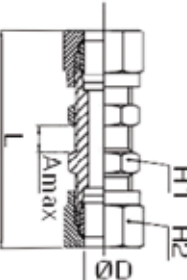

Codo tubo - tubo • Union elbow

IMOBUL	REFERENCIA	Ø D	L1	L2	H1 (Hex)	H2 (Hex)	Peso Weight(g)
	IMOBUL04	4	21	21	9	10	18
	IMOBUL06	6	23	23	9	12	22
	IMOBUL08	8	24	24	11	14	30
	IMOBUL10	10	32	32	13	19	70
	IMOBUL12	12	34,5	34,5	15	22	94
	IMOBUL14	14	38	38	17	27	152
	IMOBUL15	15	38	38	17	27	144
	IMOBUL16	16	39,5	39,5	19	30	186
	IMOBUL18	18	44	44	22	32	228

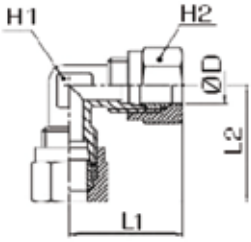

"T" Tubo • Union tee

IMOBUT	REFERENCIA	Ø D	L1	L2	H1 (Hex)	H2 (Hex)	Peso Weight(g)
	IMOBUT04	4	42	21	9	10	26
	IMOBUT06	6	46	23	9	12	30
	IMOBUT08	8	48	24	11	14	42
	IMOBUT10	10	64	32	13	19	102
	IMOBUT12	12	69	34,5	15	22	136
	IMOBUT14	14	76	38	17	27	226
	IMOBUT15	15	76	38	17	27	208
	IMOBUT16	16	79	39,5	19	30	272
	IMOBUT18	18	88	44	22	32	330

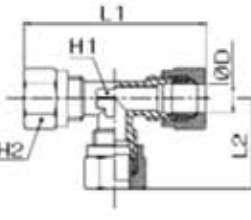

Racor directo rosca hembra cilíndrica BSPP • Female connector BSPP thread

IMOBRCF	REFERENCIA	T	Ø D	I	L	H1 (Hex)	H2 (Hex)	Peso Weight(g)
	IMOBRCF0401	G1/8"	4	8	24,5	14	10	16
	IMOBRCF0601	G1/8"	6	8	26	14	12	17
	IMOBRCF0602	G1/4"	6	11	30,5	17	12	26
	IMOBRCF0801	G1/8"	8	8	26,5	14	14	20
	IMOBRCF0802	G1/4"	8	11	31	17	14	28
	IMOBRCF0803	G3/8"	8	11,5	31	20	14	32
	IMOBRCF1002	G1/4"	10	11	35,5	17	19	46
	IMOBRCF1003	G3/8"	10	11,5	36,5	20	19	50
	IMOBRCF1203	G3/8"	12	11,5	37	20	22	58
	IMOBRCF1204	G1/2"	12	15	38,5	24	22	70
	IMOBRCF1404	G1/2"	14	15	40	24	27	98
	IMOBRCF1504	G1/2"	15	15	40,5	24	27	94
	IMOBRCF1604	G1/2"	16	16	41,5	24	30	110
	IMOBRCF1804	G1/2"	18	16	43	24	32	134
IMOBRC1804	R1/2"	18	14	43	26	32	126	

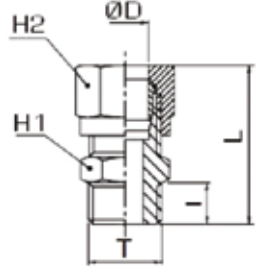

Tuerca para bicono • Locking nut

IMOTUBI	REFERENCIA	T	Ø D	I	L	H (Hex)	Peso Weight(g)
	IMOTUBI-04	M8x1	4	7,5	11	10	4,2
	IMOTUBI-06	M10x1	6	8,5	11,5	12	5,4
	IMOTUBI-08	M12x1	8	9	12	14	7
	IMOTUBI-10	M16x1,5	10	11,5	15,5	19	18,2
	IMOTUBI-12	M18x1,5	12	11,5	15,5	22	25
	IMOTUBI-14	M22x1,5	14	12	17,5	27	44,3
	IMOTUBI-15	M22x1,5	15	12	17	27	41,1
	IMOTUBI-16	M24x1,5	16	12	17,5	30	55,6
	IMOTUBI-18	M26x1,5	18	12,5	18,5	32	64,2

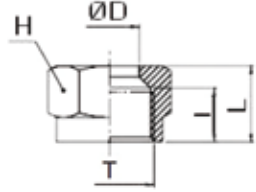

Bicono • Ogive

BICONO	REFERENCIA	Ø D1	Ø D2	L	Peso Weight(g)
	BICONO04	4	6	6	0,45
	BICONO06	6	8	7	0,82
	BICONO08	8	10	7	1,12
	BICONO10	10	13	10	3,32
	BICONO12	12	15	10	3,8
	BICONO14	14	17	10	4,4
	BICONO15	15	18	10	4,76
	BICONO16	16	19	10	5,04
	BICONO18	18	21	10,5	5,92

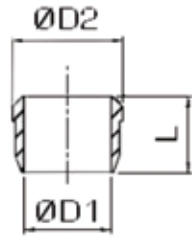

Refuerzo para bicono • Internal support bush

REFBI	REFERENCIA	Ø int. Tubo Ø int. Tube	D1	D2	L	Peso Weight(g)
	REFBI-04-25	2,5	2,5	3,5	10	0,2
	REFBI-06-04	4	4	5,5	12	0,6
	REFBI-08-55	5,5	5,5	6,7	11	0,7
	REFBI-08-06	6	6	7,5	13	1
	REFBI-10-08	8	8	9,5	14	1,4
	REFBI-12-10	10	10	11,5	16	2,2
	REFBI-14-11	11	11	12	15	2,1
	REFBI-14-12	12	12	13,5	16	2,6
	REFBI-15-125	12,5	12,5	14,5	17	2,8
	REFBI-16-13	13	13	14	15	2,5
	REFBI-16-14	14	14	15,5	18	3,4

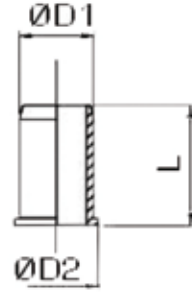

Designación de la referencia - Model designation

IMOBRC

Código
Code

06

Diámetro Tubo
Tube diameter

Código	O.D.
06	6mm
08	8mm
10	10mm
12	12mm
15	15mm
18	18mm
22	22mm
28	28mm

01

Rosca
Thread size

Cónica BSPT BSPT thread	
01	R1/8"
02	R1/4"
03	R3/8"
04	R1/2"
06	R3/4"
08	R1"
Cilíndrica BSPP BSPP thread	
01	G1/8"
02	G1/4"
03	G3/8"
04	G1/2"
06	G3/4"
08	G1"

L

Serie Ligera
Light serie

X

Acero INOX AISI 316
Stainless steel AISI 316

Datos Técnicos

Aplicaciones	Sistemas neumáticos e hidráulicos. Industria del automóvil, Química, Petrolífera, Alimentaria, Naval, ambientes corrosivos, etc. Todos los componentes de estos racores están fabricados de acuerdo a la norma DIN 2353.
Materiales utilizados	Acero inoxidable AISI 316
Rosca	Gas cónica BSPT ISO 7/1
	Gas cilíndrica BSPP ISO 228
Presión de trabajo	Diámetros 6 a 18 mm: 315 bar
	Diámetros 22 y 28mm: 160 bar
Temperatura de trabajo	De -60°C a +400°C
Tubos utilizados	Las temperaturas y presiones de trabajo, dependerán de las especificaciones de las tuberías utilizadas. Estos racores son aptos para trabajar con tubo rígido en acero inoxidable AISI 316 y tubería flexible con refuerzos interiores.
Producto conforme a la directiva 2002/95/EC 	

Technical specifications

Applications	Pneumatic and hydraulic systems, fuel heating, automotive industry, chemical, food, nautical and corrosive applications. all the fittings parts are manufactured in compliance with DIN 2353
Materials used	Stainless steel AISI 316
Threads	Taper BSPT ISO 7/1
	Cylindrical gas BSPP ISO 228
Working pressure	Diam. 6 a 18 mm: 315 bar
	Diam. 22 y 28 mm: 160 bar
Working temperature	From -60°C to +400°C
Tubes used	The working pressure & working temperatura depend on the features of the select tube. metal tubes: stainless steel. plastic tubes only internally reinforced (our item REFBI)
Products in conformity with the directive 2002/95/EC 	

Racor directo rosca macho cónica BSPT • Male connector BSPT thread

IMOBRC-X	REFERENCIA	T	ØD	I	L	H1 (Hex)	H2 (Hex)	Peso Weight(g)
	IMOBRC0601L-X	R1/8"	6	10	23	12	14	24
	IMOBRC0602L-X	R1/4"	6	13	24	17	14	39
	IMOBRC0801L-X	R1/8"	8	10	25	14	17	30
	IMOBRC0802L-X	R1/4"	8	13	25	17	17	42
	IMOBRC0803L-X	R3/8"	8	13	26	19	17	60
	IMOBRC0804L-X	R1/2"	8	16	26	22	17	80
	IMOBRC1001L-X	R1/8"	10	10	26	17	19	45
	IMOBRC1002L-X	R1/4"	10	13	26	17	19	47
	IMOBRC1003L-X	R3/8"	10	13	27	19	19	60
	IMOBRC1004L-X	R1/2"	10	16	27	22	19	83
	IMOBRC1202L-X	R1/4"	12	13	27	19	22	59
	IMOBRC1203L-X	R3/8"	12	13	27	19	22	65
	IMOBRC1204L-X	R1/2"	12	16	27	22	22	90
	IMOBRC1503L-X	R3/8"	15	13	29	24	27	93
	IMOBRC1504L-X	R1/2"	15	16	29	24	27	108
	IMOBRC1804L-X	R1/2"	18	16	31	27	32	143
	IMOBRC1806L-X	R3/4"	18	18	32	32	32	173
	IMOBRC2206L-X	R3/4"	22	18	33	32	36	195
	IMOBRC2808L-X	R1"	28	20	34	41	41	300

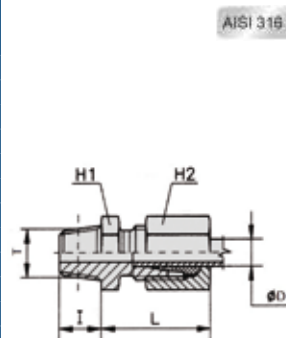

Racor directo rosca macho cilíndrica BSPP • Male connector BSPP thread

IMOBRC-G-X	REFERENCIA	T	ØD	I	L	H1 (Hex)	H2 (Hex)	Peso Weight(g)
	IMOBRC06-G01L-X	G1/8"	6	8	23	14	14	25
	IMOBRC06-G02L-X	G1/4"	6	12	25	19	14	35
	IMOBRC06-G03L-X	G3/8"	6	12	26	22	14	56
	IMOBRC08-G01L-X	G1/8"	8	8	24	14	17	31
	IMOBRC08-G02L-X	G1/4"	8	12	25	19	17	45
	IMOBRC08-G03L-X	G3/8"	8	12	26	22	17	60
	IMOBRC08-G04L-X	G1/2"	8	14	27	27	17	90
	IMOBRC10-G01L-X	G1/8"	10	8	26	17	19	40
	IMOBRC10-G02L-X	G1/4"	10	12	26	19	19	47
	IMOBRC10-G03L-X	G3/8"	10	12	27	22	19	60
	IMOBRC10-G04L-X	G1/2"	10	14	28	27	19	92
	IMOBRC12-G02L-X	G1/4"	12	12	27	19	22	61
	IMOBRC12-G03L-X	G3/8"	12	12	27	22	22	65
	IMOBRC12-G04L-X	G1/2"	12	14	28	27	22	95
	IMOBRC15-G03L-X	G3/8"	15	12	29	24	27	97
	IMOBRC15-G04L-X	G1/2"	15	14	29	27	27	115
	IMOBRC18-G04L-X	G1/2"	18	14	31	27	32	130
	IMOBRC18-G06L-X	G3/4"	18	16	30	32	32	173
	IMOBRC22-G06L-X	G3/4"	22	16	33	32	36	180
	IMOBRC28-G06L-X	G3/4"	28	16	34	41	41	256
	IMOBRC28-G08L-X	G1"	28	18	34	41	41	250

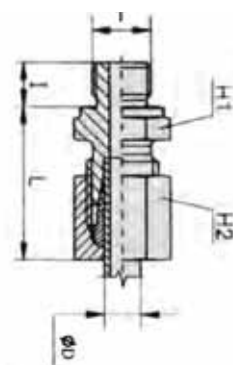

Codo rosca macho cónica BSPT • Male elbow BSPT thread

IMOBL-X	REFERENCIA	T	ØD	I	L1	L2	H1 (Hex)	H2 (Hex)	Peso Weight(g)
	IMOBL0601L-X	R1/8"	6	8	27	20	12	14	35
	IMOBL0602L-X	R1/4"	6	12	29	26	12	14	36
	IMOBL0801L-X	R1/8"	8	8	29	26	12	17	36
	IMOBL0802L-X	R1/4"	8	12	29	26	12	17	50
	IMOBL0803L-X	R3/8"	8	12	32	28	17	17	62
	IMOBL0804L-X	R1/2"	8	14	36	34	19	17	66
	IMOBL1001L-X	R1/8"	10	8	30	27	14	19	56
	IMOBL1002L-X	R1/4"	10	12	30	27	14	19	60
	IMOBL1003L-X	R3/8"	10	12	32	28	17	19	73
	IMOBL1004L-X	R1/2"	10	14	36	34	19	19	113
	IMOBL1202L-X	R1/4"	12	12	32	28	17	22	73
	IMOBL1203L-X	R3/8"	12	12	32	28	17	22	85
	IMOBL1204L-X	R1/2"	12	14	36	34	19	22	115
	IMOBL1503L-X	R3/8"	15	12	36	34	19	27	125
	IMOBL1504L-X	R1/2"	15	14	36	34	19	27	145
	IMOBL1804L-X	R1/2"	18	14	40	36	24	32	170
	IMOBL1806L-X	R3/4"	18	16	44	42	27	32	185
	IMOBL2206L-X	R3/4"	22	16	44	42	27	36	235
	IMOBL2808L-X	R1"	28	18	47	48	36	41	375

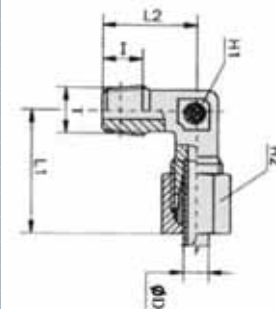

"T" Rosca macho central cónica BSPT • Male tee BSPT thread

IMOBT-X	REFERENCIA	T	ØD	I	L1	L2	H1 (Hex)	H2 (Hex)	Peso Weight(g)
	IMOBT0601L-X	R1/8"	6	8	54	20	12	14	55
	IMOBT0802L-X	R1/4"	8	12	58	26	12	17	75
	IMOBT1002L-X	R1/4"	10	12	60	27	14	19	106
	IMOBT1203L-X	R3/8"	12	12	64	28	17	22	130
	IMOBT1504L-X	R1/2"	15	14	72	34	19	27	220
	IMOBT1804L-X	R1/2"	18	14	80	36	24	32	320
	IMOBT2206L-X	R3/4"	22	16	88	42	27	36	400
	IMOBT2808L-X	R1"	28	18	94	48	36	41	560

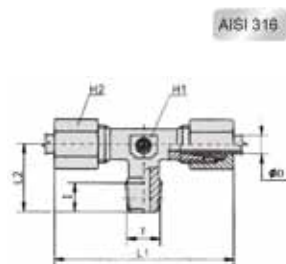

Unión recta tubo - tubo • Union connector

IMOBUC-X	REFERENCIA	ØD	L	H1 (Hex)	H2 (Hex)	Peso Weight(g)
	IMOBUC06L-X	6	39	12	14	36
	IMOBUC08L-X	8	40	14	17	50
	IMOBUC10L-X	10	42	17	19	70
	IMOBUC12L-X	12	43	19	22	87
	IMOBUC15L-X	15	46	24	27	140
	IMOBUC18L-X	18	48	27	32	200
	IMOBUC22L-X	22	52	32	36	265
	IMOBUC28L-X	28	54	41	41	320

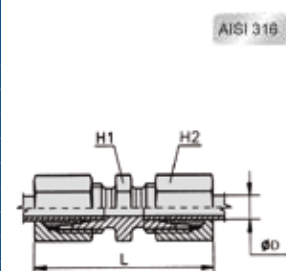

Pasatabiques tubo - tubo • Bulkhead connector

IMOBMM-X	REFERENCIA	ØD	A max	L	H1 (Hex)	H2 (Hex)	Peso Weight(g)
	IMOBMM06L-X	6	16	64	17	14	70
	IMOBMM08L-X	8	16	65	19	17	85
	IMOBMM10L-X	10	16	68	22	19	127
	IMOBMM12L-X	12	16	69	24	22	150
	IMOBMM15L-X	15	16	73	30	27	230
	IMOBMM18L-X	18	16	79	36	32	330
	IMOBMM22L-X	22	16	84	41	36	410
	IMOBMM28L-X	28	16	87	46	41	530

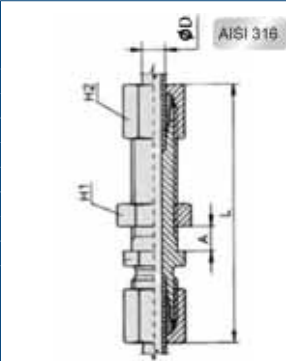

Codo tubo - tubo • Union elbow

IMOBUL-X	REFERENCIA	ØD	L	H1 (Hex)	H2 (Hex)	Peso Weight(g)
	IMOBUL06L-X	6	27	12	14	42
	IMOBUL08L-X	8	29	12	17	58
	IMOBUL10L-X	10	30	14	19	77
	IMOBUL12L-X	12	32	17	22	98
	IMOBUL15L-X	15	36	19	27	160
	IMOBUL18L-X	18	40	24	32	240
	IMOBUL22L-X	22	44	27	36	320
	IMOBUL28L-X	28	47	36	41	424

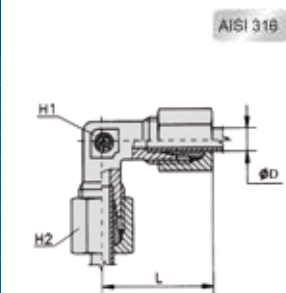

RACORES ROSCADOS
 Threaded fittings
108
B

"T" Tubo • Union tee

IMOBUT-X	REFERENCIA	ØD	L1	L2	H1 (Hex)	H2 (Hex)	Peso Weight(g)
	IMOBUT06L-X	6	54	27	12	14	63
	IMOBUT08L-X	8	58	29	12	17	85
	IMOBUT10L-X	10	60	30	14	19	115
	IMOBUT12L-X	12	64	32	17	22	150
	IMOBUT15L-X	15	72	36	19	27	245
	IMOBUT18L-X	18	80	40	24	32	358
	IMOBUT22L-X	22	88	44	27	36	479
	IMOBUT28L-X	28	94	47	36	41	745

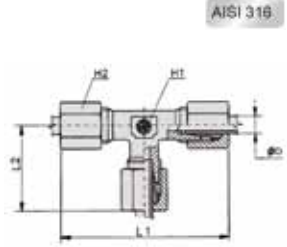

"T" Tubo • Union tee

IMOBZ-X	REFERENCIA	ØD	L1	L2	H1 (Hex)	H2 (Hex)	Peso Weight(g)
	IMOBZ06L-X	6	54	27	12	14	78
	IMOBZ08L-X	8	58	29	12	17	110
	IMOBZ10L-X	10	60	30	14	19	157
	IMOBZ12L-X	12	64	32	17	22	195
	IMOBZ15L-X	15	72	36	19	27	315
	IMOBZ18L-X	18	80	40	24	32	487
	IMOBZ22L-X	22	88	44	27	36	730
	IMOBZ28L-X	28	94	47	36	41	1015

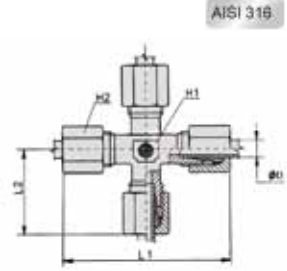

Tuerca para bicono • Locking nut

IMOTUBI-X	REFERENCIA	T	ØD	L	H (Hex)	Peso Weight(g)
	IMOTUBI-06L-X	M12X1,5	6	14,5	14	9
	IMOTUBI-08L-X	M14x1,5	8	14,5	17	12
	IMOTUBI-10L-X	M16x1,5	10	15,5	19	21
	IMOTUBI-12L-X	M18x1,5	12	15,5	22	24
	IMOTUBI-15L-X	M22x1,5	15	17	27	39
	IMOTUBI-18L-X	M26x1,5	18	18	32	59
	IMOTUBI-22L-X	M30X2	22	20	36	79
	IMOTUBI-28L-X	M36X2	28	21	41	84

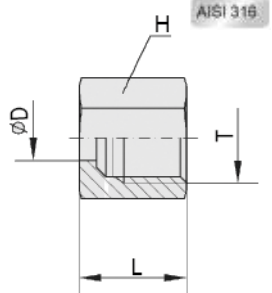

Bicono • Ogive

BICONO-X	REFERENCIA	ØD1	L	Peso Weight(g)
	BICONO06L-X	6	9,5	1,3
	BICONO08L-X	8	9,5	1,9
	BICONO10L-X	10	10	2,4
	BICONO12L-X	12	10	3,1
	BICONO15L-X	15	10	4,1
	BICONO18L-X	18	10,5	4,6
	BICONO22L-X	22	11	6
	BICONO28L-X	28	11	7,5

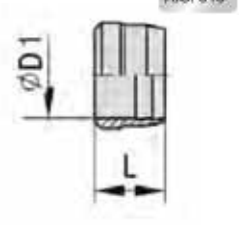

Refuerzo para bicono • Internal support bush

REFBI-X	REFERENCIA	Øint.tubo Øint.tube	D1	D2	L	Peso Weight(g)
	REFBI-04-25-X	2,5	2,5	3,3	8	x
	REFBI-06-04-X	4	4	4,8	10	x
	REFBI-08-06-X	6	6	7	11	x
	REFBI-10-08-X	8	8	9	12	1
	REFBI-12-10-X	10	10	11	14	x
	REFBI-14-12-X	12	12	13	15	x
	REFBI-18-14-X	14	14	15	16	x

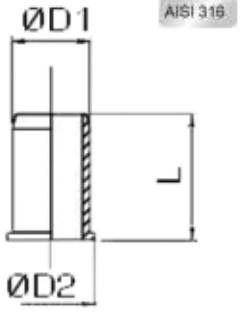

Designación de la referencia - Model designation

IMO Código Code	18 Rosca Thread size	M Tipo de Rosca M=Macho H=Hembra	E06 Diámetro Tubo Tube diameter
	Métrica Metric thread		Medidas en mm. Mm. sizes
	M5 M5		06 6mm
	M6 M6		07 7mm
	Cónica BSPT BSPT thread		08 8mm
	1 18 R1/8"		10 10mm
	2 14 R1/4"		12 12mm
	3 38 R3/8"		14 14mm
	4 12 R1/2"		17 17mm
	6 34 R3/4"		18 18mm
	8 01 R1"		20 20mm
	Cilíndrica BSPP BSPP thread		
	1 18 G1/8"		
	2 14 G1/4"		
	3 38 G3/8"		
	4 12 G1/2"		
	6 34 G3/4"		
	8 01 G1"		

Datos Técnicos

Aplicaciones	Circuitos neumáticos e hidráulicos
Materiales utilizados	Latón niquelado
Rosca	Gas cónica BSPT
	Gas cilíndrica BSPP
Presión de trabajo	Métrica
	60 Bar
La presión y temperatura de trabajo vendrán determinados por el tubo utilizado.	
Producto conforme a la directiva 2002/95/EC RoHS	

Technical specifications

Applications	Pneumatic and hydraulic systems
Materials used	Brass nickel plated
Threads	Taper gas BSPT
	Cylindrical gas BSPP
Working pressure	Metric
	60 Bar
Pressure & temperature depend on the tube used, so their values will be defined according to the features of the tube itself.	
Products in conformity with the directive 2002/95/EC RoHS	

Los datos técnicos y gráficos no son vinculantes. - Drawing and technical date are not binding.

Adaptador rosca macho cilíndrica BSPP y espiga • Male barb connector BSPP thread

	REFERENCIA	T	ØD	I	L1	L2	H (Hex)	Cresta Barb	Peso Weight(g)
	IMO18M-E06	G1/8"	6	6	29,5	19	12	6,15	8
	IMO14M-E06	G1/4"		8	32	19	14	6,15	12
	IMO18M-E08	G1/8"		6	29,5	19	12	8,15	8
	IMO14M-E08	G1/4"	8	8	32	19	14	8,15	14
	IMO38M-E08	G3/8"		9	33	19	19	8,15	22
	IMO38M-E09	G3/8"		9	33	19	19	9,2	22
	IMO18M-E10	G1/8"	10	6	30,5	20	12	10,2	10
	IMO14M-E10	G1/4"		8	33	20	14	10,2	14
	IMO38M-E10	G3/8"		9	34	20	19	10,2	23
	IMO14M-E12	G1/4"	12	8	33	20	14	12,2	16
	IMO38M-E12	G3/8"		9	34	20	19	12,2	24
	IMO12M-E12	G1/2"		10	35,5	20	22	12,2	32
	IMO38M-E14	G3/8"	14	9	36	22	19	14,25	26
	IMO12M-E14	G1/2"		10	37,5	22	22	14,25	34
	IMO12M-E17	G1/2"	17	10	39,5	24	22	17,3	38
	IMO34M-E18	G3/4"	18	11	41,5	24	30	18,5	58
IMO12M-E20	G1/2"	20	10	39,5	24	22	20,6	40	
IMO34M-E20	G3/4"		11	41,5	24	30	20,6	60	

Adaptador rosca macho cilíndrica BSPP con junta tórica para espiga • Male barb connector BSPP thread with OR

	REFERENCIA	T	ØD	I	L1	L2	H (Hex)	Cresta Barb	Peso Weight(g)
	IMO18MJ-E06	G1/8"	6	6,5	30	19	14	6,15	10
	IMO14MJ-E06	G1/4"		8	32	19	17	6,15	16
	IMO18MJ-E07	G1/8"	7	6,5	30	19	14	7,15	10
	IMO14MJ-E07	G1/4"		8	32	19	17	7,15	16
	IMO18MJ-E08	G1/8"	8	6,5	30	19	14	8,15	12
	IMO14MJ-E08	G1/4"		8	32	19	17	8,15	17
	IMO18MJ-E09	G1/8"	9	6,5	30	19	14	9,2	14
	IMO14MJ-E09	G1/4"		8	32	19	17	9,2	16
	IMO38MJ-E09	G3/8"	12	9	33	19	20	9,2	22
	IMO14MJ-E12	G1/4"		8	33	20	17	12,2	18
	IMO38MJ-E12	G3/8"	17	9	34	20	20	12,2	24
	IMO12MJ-E12	G1/2"		10	35,5	20	24	12,2	35
	IMO38MJ-E17	G3/8"	17	9	38	24	20	17,3	30
IMO12MJ-E17	G1/2"	10		39,5	24	24	17,3	42	

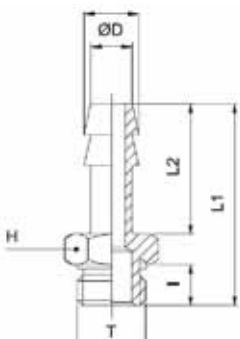

Adaptador rosca macho cónica BSPT y espiga • Male barb connector BSPT thread

	REFERENCIA	T	ØD	I	L1	L2	H (Hex)	Cresta Barb	Peso Weight(g)
	IMO18MR-E06	G1/8"	6	8	31,5	19	12	6	8
	IMO14MR-E06	G1/4"		11	35	19	14	6	14
	IMO18MR-E08	G1/8"	8	8	31,5	19	12	8	10
	IMO14MR-E08	G1/4"		11	35	19	14	8	14
	IMO14MR-E10	G1/4"	10	11	36	20	14	10	16
	IMO38MR-E10	G3/8"		11,5	36,5	20	17	10	22
	IMO12MR-E10	G1/2"	12	14	39,5	20	22	10	32
	IMO38MR-E12	G3/8"		11,5	36,5	20	17	12	22
	IMO12MR-E12	G1/2"	14	14	39,5	20	22	12	34
	IMO12MR-E14	G1/2"		14	41,5	22	22	14	36
	IMO12MR-E17	G1/2"	17	14	43,5	24	22	17	40
	IMO34MR-E18	G3/4"		18	47	24	27	18	62
	IMO34MR-E20	G3/4"	20	16,5	46,5	24	27	20	60
	IMO01MR-E25	G1"		25	56	30	34	25	114

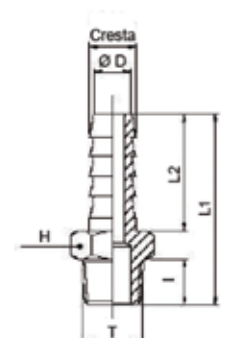

Adaptador rosca hembra cilíndrica BSPP y espiga • Female barb connector BSPP thread

	REFERENCIA	T	ØD	I	L1	L2	H (Hex)	Cresta Barb	Peso Weight(g)
	IMO14HE07	G1/4"	7	10	45,5	32,5	17	7,1	11
	IMO18H-E08	G1/8"		8	38,5	28	12	8,1	10
	IMO14H-E08	G1/4"	8	10	45	32	17	8,1	13
	IMO14H-E10	G1/4"		10	32,5	20	15	10,1	16
	IMO38H-E10	G3/8"	12	11,5	33	20	19	10,1	22
	IMO14H-E12	G1/4"		10	45,1	32,1	17	12,15	17
	IMO38H-E12	G3/8"	14	11,5	33	20	19	12,15	24
	IMO12H-E12	G1/2"		14	36	20	24	12,15	36
	IMO12H-E14	G1/2"	16	14	38	22	24	14,15	40
IMO12H-E16	G1/2"	16		38	22	24	16,15	42	

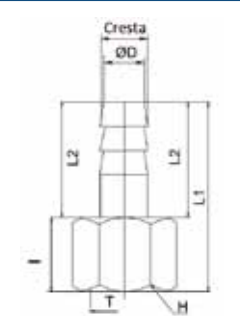

Codo rosca macho cónica BSPT y espiga • Male elbow barb connector BSPT thread

	REFERENCIA	T	ØD	I1	I2	L1	L2	H1 (Hex)	Cresta Barb	Peso Weight(g)
	CODO 1M-E06	R1/8"	6	8	18,5	22,5	14	8	6,2	10
	CODO 2M-E06	R1/4"		11	23	23	14	9	6,2	16
	CODO 1M-E07	R1/8"	7	8	18,5	22,5	14	8	7,2	10
	CODO 2M-E07	R1/4"		12	23	23	14	9	7,2	16

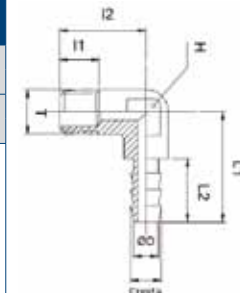

Codo rosca macho cónica BSPT espiga larga • Long male elbow barb connector BSPT thread

	REFERENCIA	T	ØD	I1	I2	L1	L2	H1 (Hex)	Cresta Barb	Peso Weight(g)
	CODO 1M-E06L	R1/8"	6	8	18,5	38	22	8	6,2	14
	CODO 1M-E07L	R1/8"	7	11	22	32,5	14	9	7,2	16

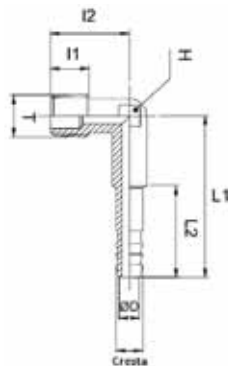

Codo 120° rosca macho cónica BSPT espiga larga • Long male elbow 120° barb connector BSPT thread

	REFERENCIA	T	ØD	I1	I2	L1	L2	H1 (Hex)	Cresta Barb	Peso Weight(g)
	CODO120 1M-E07	R1/8"	7	8	18,5	38	23	8	7,2	12

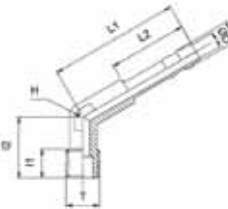

Adaptador rosca macho cilíndrica BSPP y métrica • Nipple BSPP and metric thread

	REFERENCIA	T	ØC	L	L1	H (Hex)	Peso Weight(g)
	IMOM5M-M5M	M5	2,5	11	4	8	1
	IMO18M-18M-C	G1/8"	6	18,5	7	14	9
	IMO14M-14M-C	G1/4"	8,5	21	8	17	15
	IMO38M-38M-C	G3/8"	11,5	23	9	19	21
	IMO12M-12M-C	G1/2"	15	25	10	24	34
	IMO34M-34M-C	G3/4"	20	27,5	11	30	53
	IMO01M-01M-C	G1"	26	32	13	36	84

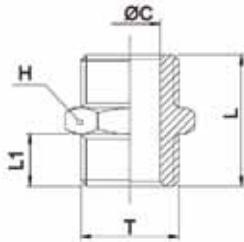

Reducción rosca macho cilíndrica BSPP y métrica • Reduced nipple BSPP and metric thread

	REFERENCIA	T1	T2	ØC1	ØC2	I1	I2	L	H1 (Hex)	Peso Weight(g)
	IMO18M-M5M	M5	G1/8"	2,5	6	5	6,5	15,5	14	7
	IMO18M-14M-C	G1/8"	G1/4"	5,5	8,5	6,5	8	19	17	14
	IMO18M-38M-C	G1/8"	G3/8"	5,5	11,5	6,5	9	20,5	19	19
	IMO14M-38M-C	G1/4"	G3/8"	8,5	11,5	8	9	22	19	19
	IMO14M-12M-C	G1/4"	G1/2"	8	15	9	10	24,5	24	35
	IMO38M-12M-C	G3/8"	G1/2"	11	15	9	10	24,5	24	36
	IMO38M-34M-C	G3/8"	G3/4"	11	20	10	11	26,5	30	52
	IMO12M-34M-C	G1/2"	G3/4"	15	20	11	11	27,5	30	52
	IMO34M-01M-C	G3/4"	G1"	20	25,5	11	13	30	36	71

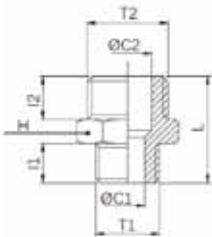

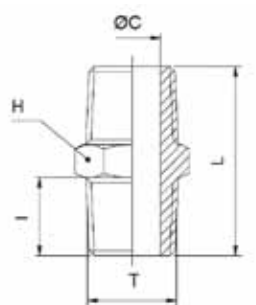

Adaptador rosca macho cónica BSPT • Nipple BSPT thread

	REFERENCIA	T	ØC	I	L	H (Hex)	Peso Weight(g)
	IMO18M-18M	R1/8"	6	7,5	19	12	7
	IMO14M-14M	R1/4"	8,5	11	26,5	14	16
	IMO38M-38M	R3/8"	11,5	11	27	17	23
	IMO12M-12M	R1/2"	15	12,5	30,5	22	79
	IMO34M-34M	R3/4"	20	14	34,5	27	61
	IMO01M-01M	R1"	26	15,5	37	34	92

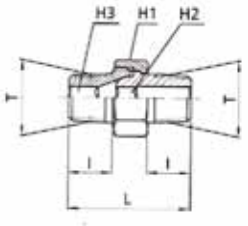

Enlace tres piezas macho-macho con rosca cónica BSPT • M/M nipple three pieces BSPT thread

	REFERENCIA	T	I	L	H1 (Hex)	H2 (Hex)	H2 (Hex)	Peso Weight(g)
NUEVO 	IMO18M-18M-3P	R1/8"	9	27	15	5	5	59
	IMO14M-14M-3P	R1/4"	12	33,5	19	6	6	65
	IMO38M-38M-3P	R3/8"	13	36,5	22	8	8	71
	IMO12M-12M-3P	R1/2"	16	44	27	12	12	86
	IMO34M-34M-3P	R3/4"	18	53	36	14	14	103
	IMO01M-01M-3P	R1"	22	64	46	19	19	124
* Latón sin niquelar								

Reducción rosca macho cónica BSPT • Reduced nipple BSPT thread

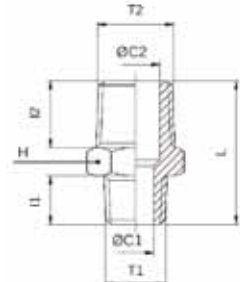
	REFERENCIA	T1	T2	ØC1	ØC2	I1	I2	L	H (Hex)	Peso Weight(g)
	IMO18M-14M	R1/8"	R1/4"	5,5	8,5	7,5	11	23	14	12
	IMO18M-38M	R1/8"	R3/8"	5,5	11,5	7,5	11	23,5	17	19
	IMO14M-38M	R1/4"	R3/8"	8,5	11,5	10,5	11	26,5	17	21
	IMO14M-12M	R1/4"	R1/2"	8	15	10,5	12,5	28,5	22	32
	IMO38M-12M	R3/8"	R1/2"	11	15	10,5	12,5	28,5	22	35
	IMO12M-34M	R1/2"	R3/4"	15	20	12,5	14	32,5	27	58
	IMO34M-01M	R3/4"	R1"	20	25,5	13	15,5	35,5	34	91

Adaptador rosca macho-hembra cilíndrica BSPP y métrica • M/F BSPP thread enlarger

	REFERENCIA	T1	T2	B	ØC	ØD	I1	I2	E	L	H (Hex)	Peso Weight(g)
	IMOM5M-M5H	M5	M5	1,5	2,5	7,5	4,5	5	6,5	11	8	1
	IMOM5M-18H-C	M5	G1/8"	2	2,2	13,5	5	7	11	16	14	10
	IMOM6M-18H-C	M6	G1/8"	2	2,7	13,5	6	7	11	17	14	10
	IMO18M-18H-C	G1/8"	G1/8"	2	5,5	13,5	6,5	8	11	17,5	14	11
	IMO18M-14H-C	G1/8"	G1/4"	2	5,5	16,5	6,5	10,5	13,5	20	17	18
	IMO18M-38H-C	G1/8"	G3/8"	2,5	5,5	21,5	6,5	10,5	14	20,5	22	33
	IMO14M-14H-C	G1/4"	G1/4"	2	8,5	16,5	8	10,5	13,5	21,5	17	19
	IMO14M-38H-C	G1/4"	G3/8"	2,5	8	21,5	9	10,5	14	23	22	32
	IMO14M-12H-C	G1/4"	G1/2"	3	8	26,5	9	12,5	17	26	27	51
	IMO38M-38H-C	G3/8"	G3/8"	2,5	11	21,5	9	10,5	14	23	22	32
	IMO38M-12H-C	G3/8"	G1/2"	3	11	26,5	9	12,5	17	26	27	54
	IMO38M-34H-C	G3/8"	G3/4"	3	11	31,5	9	12,5	17	26	32	66
	IMO12M-12H-C	G1/2"	G1/2"	3	15	26,5	10,5	12,5	16	26,5	27	56
	IMO12M-34H-C	G1/2"	G3/4"	3	15	31,5	10,5	12,5	17	27,5	32	71
	IMO12M-01H-C	G1/2"	G1"	3	15	37,5	11	12,5	18	29	38	93
	IMO34M-34H-C	G3/4"	G3/4"	3	20	31,5	10,5	12,5	17	27,5	32	69
	IMO34M-01H-C	G3/4"	G1"	3	20	37,5	11	12,5	18	29	38	93
	IMO01M-01H-C	G1"	G1"	3	26	37,5	13	12,5	18	31	38	96



Adaptador rosca macho cónica BSPT y hembra cilíndrica BSPP • M BSPT thread / F BSPP thread enlarger

	REFERENCIA	T1	T2	B	ØC	ØD	I1	I2	E	L	H (Hex)	Peso Weight(g)
	IMO18M-18H	R1/8"	G1/8"	2	5,5	13,5	7,5	8	11	18,5	14	12
	IMO18M-14H	R1/8"	G1/4"	2	5,5	16,5	7,5	10,5	13,5	21	17	18
	IMO18M-38H	R1/8"	G3/8"	2,5	5,5	21,5	7,5	10,5	14	21,5	22	31
	IMO14M-14H	R1/4"	G1/4"	2	8,5	16,5	10,5	10,5	13,5	24	17	18
	IMO14M-38H	R1/4"	G3/8"	2,5	8	21,5	10,5	10,5	14	24,5	22	32
	IMO14M-12H	R1/4"	G1/2"	3	8	26,5	10,5	12,5	17	27,5	27	52
	IMO38M-38H	R3/8"	G3/8"	2,5	11	21,5	10,5	10,5	14	24,5	22	37
	IMO38M-12H	R3/8"	G1/2"	3	11	26,5	10,5	12,5	17	27,5	27	55
	IMO38M-34H	R3/8"	G3/4"	3	11	31,5	11	12,5	17	28	32	74
	IMO12M-12H	R1/2"	G1/2"	3	15	26,5	12,5	12,5	16	28,5	27	54
	IMO12M-34H	R1/2"	G3/4"	3	15	31,5	12,5	12,5	17	29,5	32	70
	IMO12M-01H	R1/2"	G1"	3	15	37,5	13	12,5	18	31	38	91
	IMO34M-34H	R3/4"	G3/4"	3	20	31,5	13	12,5	17	30	32	74
	IMO34M-01H	R3/4"	G1"	3	20	37,5	13	12,5	18	31	38	97
	IMO01M-01H	R1"	G1"	3	26	37,5	15,5	12,5	18	33,5	38	100



Manguito rosca hembra cilíndrica BSPP y métrica • F/F sleeve BSPP thread and metric

	REFERENCIA	T	ØD	B	L	H (Hex)	Peso Weight(g)
	IMOM5H-M5H	M5	7,5	3,5	11	8	1
	IMO18H-18H	G1/8"	13,5	5	15	14	10
	IMO14H-14H	G1/4"	16,5	8	22	17	18
	IMO38H-38H	G3/8"	21,5	8,5	24	22	37
	IMO12H-12H	G1/2"	26,5	10	29	27	62
	IMO34H-34H	G3/4"	31,5	10	29	32	70
	IMO01H-01H	G1"	37,5	11	31	38	89

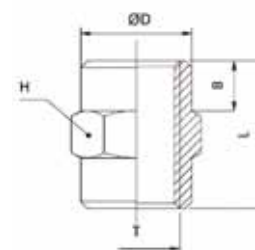

Reducción rosca hembra cilíndrica BSPP y métrica • Reduced F/F sleeve BSPP thread and metric

	REFERENCIA	T1	T2	ØD1	ØD2	I	E	F	L	H (Hex)	Peso Weight(g)
	IMO18H-M5H	M5	G1/8"	8	13,5	7	3,5	4,5	12,5	14	9
	IMO18H-14H	G1/8"	G1/4"	13	16,5	11	6	8	20	17	18
	IMO18H-38H	G1/8"	G3/8"	14	21,5	11	6	8	20	22	28
	IMO14H-38H	G1/4"	G3/8"	17	21,5	11	7	8	21	22	30
	IMO14H-12H	G1/4"	G1/2"	17	26,5	13	8	9	24	27	46
	IMO38H-12H	G3/8"	G1/2"	21,5	26,5	13	8	9	24	27	48
	IMO38H-34H	G3/8"	G3/4"	21	31,5	13,5	8	10	25	32	64
	IMO12H-34H	G1/2"	G3/4"	26	31,5	13,5	8	10	25	32	65
	IMO12H-01H	G1/2"	G1"	26	37	14	8	10	25	38	84
	IMO34H-01H	G3/4"	G1"	32	37	14	8	10	25	38	83

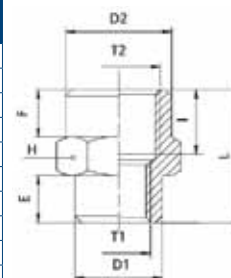

Prolongación rosca macho-hembra cilíndrica BSPP • M/F extension BSPP thread

	REFERENCIA	T1	T2	I1	I2	L1	L2	H (Hex)	Peso Weight(g)
	IMO18M18H-L23	G1/8"	G1/8"	6	8	23	16	14	14
	IMO18M18H-L44	G1/8"	G1/8"	6	8	44	36	14	30
	IMO14M14H-L35	G1/4"	G1/4"	8	11	35	27	17	32
	IMO14M14H-L51	G1/4"	G1/4"	8	11	51	43	17	46

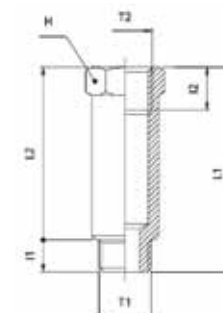

Reducción rosca macho cónica BSPT rosca hembra cilíndrica BSPP • M BSPT thread / F BSPP thread reducer

	REFERENCIA	T1	T2	ØC	I1	I2	L	H (Hex)	Peso Weight(g)
	IMOC14M-18H	R1/4"	G1/8"	6	11	9	15,5	14	9
	IMOC38M-18H	R3/8"	G1/8"	6,5	11	9	15,5	17	21
	IMOC38M-14H		G1/4"	8,5		11			13
	IMOC12M-18H	R1/2"	G1/8"	6	12,5	10	18	22	42
	IMOC12M-14H		G1/4"	8,5		11,5			34
	IMOC12M-38H		G3/8"	11,5		11,5			25
	IMOC34M-14H	R3/4"	G1/4"	8,5	14	12	20	27	74
	IMOC34M-38H		G3/8"	11,5		12			62
	IMOC34M-12H		G1/2"	15		14			43
	IMOC01M-38H	R1"	G3/8"	15	15,5	13	21,5	34	123
	IMOC01M-12H		G1/2"	15		14			104
	IMOC01M-34H		G3/4"	20		14			73

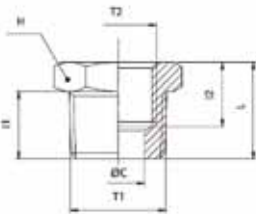

Reducción rosca macho cilíndrica BSPP - rosca hembra cilíndrica BSPP • M/F reducer BSPP thread

	REFERENCIA	T1	T2	I	L	H (Hex)	Peso Weight(g)
	IMOC18MC-M5H	G1/8"	M5	6,5	10,5	14	7
	IMOC14MC-18H	G1/4"	G1/8"	8	12,5	17	10
	IMOC38MC-18H	G3/8"	G1/8"	9	14	19	18
	IMOC38MC-14H		G1/4"				13
	IMOC12MC-18H	G1/2"	G1/8"	10	15	24	39
	IMOC12MC-14H		G1/4"				32
	IMOC12MC-38H		G3/8"				21
	IMOC34MC-14H	G3/4"	G1/4"	11	16,5	30	64
	IMOC34MC-38H		G3/8"				52
	IMOC34MC-12H		G1/2"				36
	IMOC01MC-38H	G1"	G3/8"	13,5	19,5	36	110
	IMOC01MC-12H		G1/2"	13	19		90
	IMOC01MC-34H		G3/4"	13	19		59

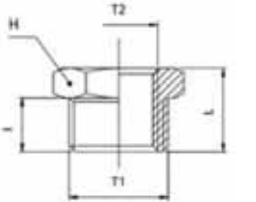

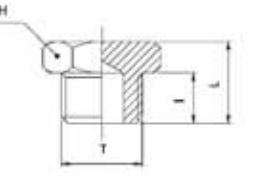

Tapón rosca macho cilíndrica BSPP y métrica • M plug BSPP thread and metric

	REFERENCIA	T	I	L	H (Hex)	Peso Weight(g)
	TAP.CIL.-M5M	M5	4,5	7,5	8	4
	TAP.CIL.-1M	G1/8"	6	10	14	7
	TAP.CIL.-2M	G1/4"	8	12,5	17	12
	TAP.CIL.-3M	G3/8"	9	13,5	19	19
	TAP.CIL.-4M	G1/2"	10	15	24	28
	TAP.CIL.-6M	G3/4"	11	16,5	30	46
	TAP.CIL.-8M	G1"	12,5	18,5	36	79



Tapón rosca macho cónica BSPT • M plug BSPT thread

	REFERENCIA	T	I	L	H (Hex)	Peso Weight(g)
	IMOTC18M	R1/8"	7,5	11,5	10	4
	IMOTC14M	R1/4"	11	15,5	14	9
	IMOTC38M	R3/8"	11	16	17	17
	IMOTC12M	R1/2"	12	17,5	22	29
	IMOTC34M	R3/4"	13,5	19,5	27	60
	IMOTC1M	R1"	15,5	22	34	92



Tapón rosca macho cilíndrica BSPP con junta tórica y exágono interior • M plug BSPP thread with exagon embedded and OR

	REFERENCIA	T	I	L	ØD	H (Hex)	Peso Weight(g)
	IMOTCJM5M	M5	4,5	7,2	8	2,5	1,4
	IMOTCJ18M	G1/8"	6,5	9,5	14	5	6
	IMOTCJ14M	G1/4"	8	11,5	17	6	12
	IMOTCJ38M	G3/8"	9	12,5	20	8	18
	IMOTCJ12M	G1/2"	10	14	26	10	32

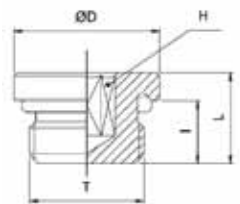

Tapón rosca hembra cilíndrica BSPP • F plug BSPP thread

	REFERENCIA	T	I	L	H (Hex)	Peso Weight(g)
	TAPCIL-M5H	M5	5,5	7	8	1
	TAP.CIL.-1H	G1/8"	9	11	14	5
	TAP.CIL.-2H	G1/4"	11	13	17	17
	TAP.CIL.-3H	G3/8"	11	13,5	21	23
	TAP.CIL.-4H	G1/2"	11	13,5	24	44
	TAP.CIL.-6H	G3/4"	12,5	15	30	44
	TAP.CIL.-8H	G1"	12,5	15	38	56

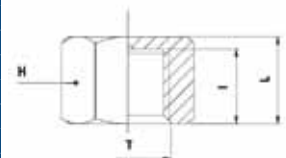

Tapón rosca macho cónica BSPT con exágono interior • M flat plug BSPT thread exagon embedded

	REFERENCIA	T	L	L	Peso Weight(g)
	TAP.CON.-1M	R1/8"	8	5	3
	TAP.CON.-2M	R1/4"	10	6	7
	TAP.CON.-3M	R3/8"	10,5	8	23
	TAP.CON.-4M	R1/2"	13	10	24

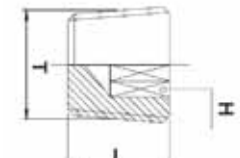

Codo rosca hembra cilíndrica BSPP y métrica • F/F elbow BSPP thread and metric

	REFERENCIA	T	I	D	L	H (Hex)	Peso Weight(g)
	CODO M5H	M5	5,5	9	11	8	6
	CODO 1H	G1/8"	8	13,5	20,5	10	19
	CODO 2H	G1/4"	11,5	16,5	31	13	33
	CODO 3H	G3/8"	12	21	36	17	57
	CODO 4H	G1/2"	15	26	44	21	109
	CODO 6H	G3/4"	16,5	32	36,5	25	144
	CODO 8H	G1"	19	39	45	30	244

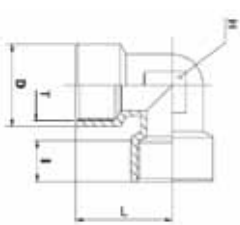

Codo rosca macho cónica BSPT y hembra cilíndrica BSPP y métrica • M/F elbow BSPT thread

	REFERENCIA	T1	T2	I1	I2	L1	L2	H (Hex)	Peso Weight(g)
	CODOM5HM5M	M5	M5	5	5,5	11,5	11	8	7
	CODO 1H-1M	R1/8"	G1/8"	9,5	8	17,5	19,5	10	16
	CODO 2H-2M	R1/4"	G1/4"	11,5	11,5	24	25	13	31
	CODO 3H-3M	R3/8"	G3/8"	13	12	27,5	27,5	17	46
	CODO 4H-4M	R1/2"	G1/2"	15	15	30	33,5	21	92
	CODO 6H-6M	R3/4"	G3/4"	16	16,5	33	36,5	25	120
	CODO 8H-8M	R1"	G1"	17	19	39	45	30	212

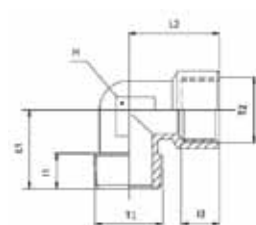

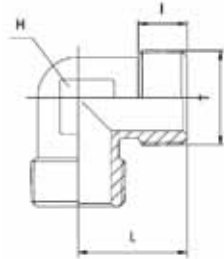

Codo rosca macho cónica BSPT y métrica • M/M elbow BSPT thread and metric

	REFERENCIA	T	I	L	H (Hex)	Peso Weight(g)
	CODO M5M	M5	5	13,5	8	6
	CODO 1M	R1/8"	9	18,5	10	13
	CODO 2M	R1/4"	11,5	22	12	20
	CODO 3M	R3/8"	13	26	13	31
	CODO 4M	R1/2"	14	28,5	17	55
	CODO 6M	R3/4"	16	33	25	100
	CODO 8M	R1"	17	39	30	174

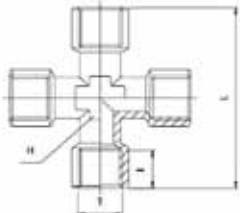

Cruz rosca hembra cilíndrica BSPP • F/F/F/F elbow BSPP equal cross

	REFERENCIA	T	I	L	H (Hex)	Peso Weight(g)
	CRUZ-1H	G1/8"	8	42	10	38
	CRUZ-2H	G1/4"	11	51	13	76
	CRUZ-3H	G3/8"	11,5	56	17	108
	CRUZ-4H	G1/2"	14	67	21	186

Cruz rosca macho cónica BSPT hembra cilíndrica BSPP • M/F/F/F equal cross

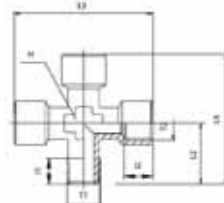
	REFERENCIA	T1	T2	I1	I2	L1	L2	L3	H (Hex)	Peso Weight(g)
	CRUZ-H-1M	R1/8"	G1/8"	8	8	39,5	18,5	42	10	34
	CRUZ-H-2M	R1/4"	G1/4"	11	11	49	23,5	51	13	68
	CRUZ-H-3M	R3/8"	G3/8"	11,5	11,5	54	26	56	17	100
	CRUZ-H-4M	R1/2"	G1/2"	14	14	64,5	31	67	21	168

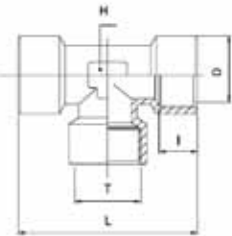

"T" Rosca hembra cilíndrica BSPP y métrica • F/F/F tee

	REFERENCIA	T	I	L	H (Hex)	Peso Weight(g)
	T-M5H	M5	5,5	26,5	8	7
	T-1H	G1/8"	8	40	10	28
	T-2H	G1/4"	11,5	50	13	49
	T-3H	G3/8"	12	57	17	85
	T-4H	G1/2"	15	68,5	21	146
	T-6H	G3/4"	16,5	73	25	194
	T-8H	G1"	19	90	30	326

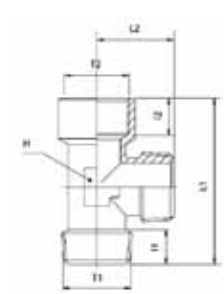

"T" Rosca macho lateral y central cónica BSPT y hembra lateral cilíndrica BSPP • M/M/F tee

	REFERENCIA	T1	T2	I1	I2	L1	L2	H (Hex)	Peso Weight(g)
	T-M5H-L	M5	M5	5	5,5	26	13	8	8
	T-1H-L	R1/8"	G1/8"	9,5	8	38,5	18,5	10	25
	T-2H-L	R1/4"	G1/4"	11,5	11,5	47,5	23,5	13	43
	T-3H-L	R3/8"	G3/8"	13	12	56	26	17	72
	T-4H-L	R1/2"	G1/2"	15	15	67,5	32	21	102
	T-6H-L	R3/4"	G3/4"	16	16,5	69,5	33	25	156
	T-8H-L	R1"	G1"	17,5	19	84	39	30	268



"T" Rosca macho cónica BSPT y métrica • M/M/M tee

	REFERENCIA	T	I	L1	L2	H (Hex)	Peso Weight(g)
	T-M5M	M5	5	27,5	13,5	8	8
	T-1M	R1/8"	9,5	36	17	10	20
	T-2M	R1/4"	11,5	48	24	12	38
	T-3M	R3/8"	12	48	24	13	47
	T-4M	R1/2"	15	57	28	17	80
	T-6M	R3/4"	16,2	66,4	33	25	134
	T-8M	R1"	17,5	78	39	30	236

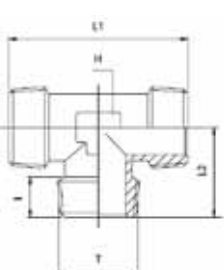

"T" Rosca central hembra cilíndrica BSPP lateral macho cónica BSPT y métrica • M/F/M tee

	REFERENCIA	T1	T2	I1	I2	L1	L2	H (Hex)	Peso Weight(g)
	T-M5H-C	M5	M5	5	5,5	27,5	13	8	6
	T-1H-C	R1/8"	G1/8"	9,5	8	36,5	19,5	10	22
	T-2H-C	R1/4"	G1/4"	11,5	11,5	48	25,5	13	37
	T-3H-C	R3/8"	G3/8"	13	12	51,5	28	17	62
	T-4H-C	R1/2"	G1/2"	15	15	63	34	21	118
	T-6H-C	R3/4"	G3/4"	16	16,5	66,4	36,5	25	156
	T-8H-C	R1"	G1"	17,5	19	78	45	30	268

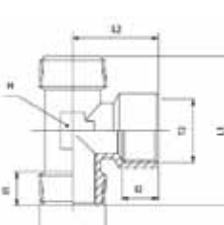

"T" Rosca central macho cónica BSPT lateral hembra cilíndrica BSPP y métrica • F/M/F tee

	REFERENCIA	T1	T2	I1	I2	L1	L2	H (Hex)	Peso Weight(g)
	T-M5M-C	M5	M5	5	5,5	26,5	11,5	8	9
	T-1M-C	R1/8"	G1/8"	9,5	8	40	18,5	10	22
	T-2M-C	R1/4"	G1/4"	11,5	11,5	50	24,5	13	49
	T-3M-C	R3/8"	G3/8"	13	12	57	26,5	17	75
	T-4M-C	R1/2"	G1/2"	15	15	68,5	32	21	127
	T-6M-C	R3/4"	G3/4"	16	16,5	73	33	25	178
	T-8M-C	R1"	G1"	17,5	19	90	39	30	296

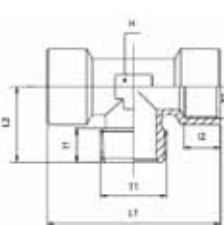

"T" Rosca lateral macho cónica BSPT central y lateral hembra cilíndrica BSPP y métrica • M/F/F tee

	REFERENCIA	T1	T2	I1	I2	L1	L2	L3	H (Hex)	Peso Weight(g)
	T-M5M-L	M5	M5	5	5,5	26	13	12	8	9
	T-1M-L	R1/8"	G1/8"	9,5	8	38,5	19,5	18,5	10	24
	T-2M-L	R1/4"	G1/4"	11,5	11,5	49	25	24	13	44
	T-3M-L	R3/8"	G3/8"	13	12	54	28,5	25,5	17	74
	T-4M-L	R1/2"	G1/2"	15	15	65,5	34,5	31	21	132
	T-6M-L	R3/4"	G3/4"	16	16,5	69,5	36,5	33	25	172
	T-8M-L	R1"	G1"	17,5	19	84	45	39	30	298

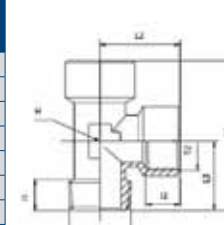

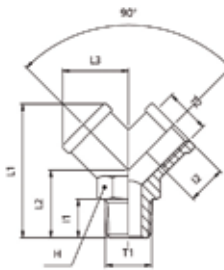

"Y" Rosca central macho cónica BSPT lateral hembra cilíndrica BSPP • F/M/F Y

	REFERENCIA	T1	T2	I1	I2	L1	L2	L3	H (Hex)	Peso Weight(g)
	Y-1M	R1/8"	G1/8"	8	8	32	16	14,5	13	22
	Y-2M	R1/4"	G1/4"	11	11	38	20	18	17	38
	Y-3M	R3/8"	G3/8"	11,5	11,5	42,5	22	20,5	20	52
	Y-4M	R1/2"	G1/2"	14	14	53	27	26,5	25	110

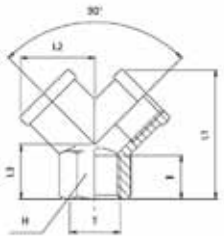

"Y" Rosca hembra cilíndrica BSPP • F/F/F Y

	REFERENCIA	T	I	L1	L2	L3	H (Hex)	Peso Weight(g)
	Y-1H	G1/8"	8	26,5	14,5	12	13	18
	Y-2H	G1/4"	11	32	18	14	17	32
	Y-3H	G3/8"	11,5	37	20,5	16	20	44
	Y-4H	G1/2"	14	45	26,5	19	25	92

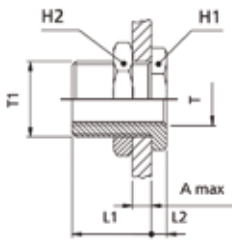

Pasatabique rosca hembra cilíndrica BSPP • F/F bulkhead connector

	REFERENCIA	T	T1	A max	L1	L2	H1 (Hex)	H2 (Hex)	Peso Weight(g)
	IMOMMM5M5	M5	M10x1	7	10,5	3,5	14	14	12
	IMOMM0101	G1/8"	M16x1,5	10	14	4	19	22	30
	IMOMM0202	G1/4"	M20x1,5	16	21	4	24	27	58
	IMOMM0303	G3/8"	M26x1,5	15	21	5	30	32	94
	IMOMM0404	G1/2"	M28x1,5	21	27	6	32	36	116

Purgador manual rosca macho cónica BSPT • Drain valve male BSPT thread

	REFERENCIA	T
	PURGA1/8	R1/8"
	PURGA1/4	R1/4"
	PURGA3/8	R3/8"
	PURGA1/2	R1/2"

Rótula giratoria universal • Universal swivel ball joint

	REFERENCIA	ROSCA M	ROSCA H
	ROTULA1/4	R1/4"	R1/4"
	ROTULA3/8	R3/8"	R3/8"

Designación de la referencia - Model designation

AD	M/H	1
Código Code	Rosca Macho/Hembra Male/Female Threads	Rosca Thread size
Cónica BSPT BSPT thread		
1	R1/8"	
2	R1/4"	
3	R3/8"	
4	R1/2"	
6	R3/4"	
Cilíndrica BSPP BSPP thread		
1	G1/8"	
2	G1/4"	
3	G3/8"	
4	G1/2"	
6	G3/4"	

Datos Técnicos

Aplicaciones	Neumática. Fluidos en sector alimentario, químico, medicinal y farmacéutico
Materiales Utilizados	Cuerpo: acero AISI 303 y AISI 316
Roscas	Gas cónica BSPT Gas cilíndrica BSPP
Presión Trabajo	PN 150
Temperatura de trabajo	de -20°C a +180°C
Producto conforme a la directiva 2002/95/EC RoHS	

Technical specifications

Applications	Pneumatics, fluids, food, chemical, medical & pharmaceutical applications
Materials used	Body: stainless steel AISI 303 and AISI 316
Threads	Taper Gas BSPT Thread Cylindrical Gas BSPP Thread
Working pressure	PN 150
Working temperature	From -20°C to +180°C
Products in conformity with the directive 2002/95/EC RoHS	

Los datos técnicos y gráficos no son vinculantes. - Drawing and technical date are not binding.

Adaptador rosca macho cónica BSPT • Nipple BSPT thread

	REFERENCIA	T	PN(Bar)	ØC	L1	L2	H (Hex)	Peso Weight(g)		
	303									
	AD-1M-1M-X	R1/8"	150	5	24	9	12	11,3		
	AD-2M-2M-X	R1/4"	150	7	27	10,5	14	19,6		
	AD-3M-3M-X	R3/8"	150	10	30	11,5	17	29,9		
	AD-4M-4M-X	R1/2"	150	13	38	15	22	58		
	AD-6M-6M-X	R3/4"	150	18	46	18	27	95,4		
	316									
	AD-1M-1M-316X	R1/8"	150	5	24	9	13	11,3		
	AD-2M-2M-316X	R1/4"	150	7	27	10,5	14	19,6		
	AD-3M-3M-316X	R3/8"	150	10	30	11,5	17	29,9		
	AD-4M-4M-316X	R1/2"	150	13	38	15	22	58		
	AD-6M-6M-316X	R3/4"	150	18	46	18	27	95,4		



Reducción rosca macho cónica BSPT • Reduced nipple BSPT thread

	REFERENCIA	T1	T2	PN (Bar)	ØC1	ØC2	L1	L2	L3	L4	L5	H (Hex)	Peso Weight(g)		
	303														
	AD-1M-2M-X	R1/8"	R1/4"	150	7	5	25,5	10,5	9	15	9,9	14	15,9		
	AD-2M-3M-X	R1/4"	R3/8"	150	7	10	29	10,5	11,5	13,1	15	17	26,6		
	AD-2M-4M-X	R1/4"	R1/2"	150	7	13	33	10,5	15	13,27	18	22	45,3		
	AD-3M-4M-X	R3/8"	R1/2"	150	10	13	34	11,5	15	15,1	18	22	48,5		
	AD-4M-6M-X	R1/2"	R3/4"	150	13	18	43	15	18	19,6	22	27	87,1		
	316														
	AD-1M-2M-316X	R1/8"	R1/4"	150	7	5	25,5	10,5	9	15	9,9	14	15,9		
	AD-2M-3M-316X	R1/4"	R3/8"	150	7	10	29	10,5	11,5	13,1	15	17	26,6		
	AD-2M-4M-316X	R1/4"	R1/2"	150	7	13	33	10,5	15	13,27	18	22	45,3		
	AD-3M-4M-316X	R3/8"	R1/2"	150	10	13	34	11,5	15	15,1	18	22	48,5		
	AD-4M-6M-316X	R1/2"	R3/4"	150	13	18	43	15	18	19,6	22	27	87,1		

Reducción rosca macho cónica BSPT / hembra cilíndrica BSPP • M BSPT thread / F BSPP thread enlarger

	REFERENCIA	T1	T2	PN (Bar)	ØC	ØP	L1	L2	L3	L4	L5	H (Hex)	Peso Weight(g)		
	316														
	AD-1M-2H-316X	R1/8"	G1/4"	150	5	16,5	22	8	11	9,1	8	17	16,2		
	AD-2M-3H-316X	R1/4"	G3/8"	150	7	21,5	27	11	13	11,7	9,5	22	33,2		
AD-3M-4H-316X	R3/8"	G1/2"	150	10	26,5	30	11	15	12,4	11,5	27	54,6			

Manguito rosca hembra cilíndrica BSPP • F/F sleeve BSPP thread

	REFERENCIA	T	PN(Bar)	ØP	L1	L2	H (Hex)	Peso Weight(g)	
	316								
	AD-1H-1H-316X	G1/8"	150	13	15	5	14	8,9	
	AD-2H-2H-316X	G1/4"	150	16,5	22	7,5	17	17,4	
	AD-3H-3H-316X	G3/8"	150	21,5	25	8,5	22	34,4	
	AD-4H-4H-316X	G1/2"	150	26,5	32	11	27	64,4	
	AD-6H-6H-316X	G3/4"	150	31,5	34	12	32	79,3	

Reducción rosca hembra cilíndrica BSPP • Reduced F/F sleeve BSPP thread

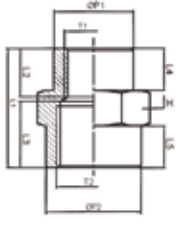
	REFERENCIA	T1	T2	PN (Bar)	ØP1	ØP2	L1	L2	L3	L4	L5	H (Hex)	Peso Weight(g)		
	303														
	AD-1H-2H-X	G1/8"	G1/4"	150	13,5	16,5	23	9,1	13	7	9	17	18,4		
	316														
	AD-1H-2H-316X	G1/8"	G1/4"	150	13,5	16,5	23	9,1	13	7	9	17	18,4		
	AD-2H-3H-316X	G1/4"	G3/8"	150	18	21,5	27	11	15	9,5	9,5	22	36,2		
	AD-2H-4H-316X	G1/4"	G1/2"	150	18	26,5	30	10,8	17	9,5	10,5	27	56,8		
	AD-3H-4H-316X	G3/8"	G1/2"	150	21,5	26,5	30	11,8	17	8	13	27	61,6		
	AD-4H-6H-316X	G1/2"	G3/4"	150	26,5	31,5	36	14,6	20	11	15	32	88,3		

Adaptador rosca macho cónica BSPT / hembra cilíndrica BSPP • M BSPT thread / F BSPP thread reducer

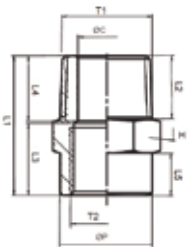
	REFERENCIA	T1	T2	PN (Bar)	ØP	ØC	L1	L2	L3	L4	L5	H (Hex)	Peso Weight(g)		
	303														
	AD-1H-2M-X	G1/8"	R1/4"	150	13,5	7	23,5	11	9	13	7	14	16		
	AD-2H-3M-X	G1/4"	R3/8"	150	16,5	10	26,5	11,5	12	13,1	8	17	23,7		
	AD-3H-4M-X	G3/8"	R1/2"	150	21,4	13	33	15	17	15,4	10	22	47		
	316														
	AD-1H-2M-316X	G1/8"	R1/4"	150	13,5	7	23,5	11	9	13	7	14	16		
	AD-2H-3M-316X	G1/4"	R3/8"	150	16,5	10	26,5	11,5	12	13,1	8	17	23,7		
AD-3H-4M-316X	G3/8"	R1/2"	150	21,4	13	33	15	17	15,4	10	22	47			

Tapón rosca macho cónica BSPT con hexágono interior • M plug BSPT thread with hexagon embedded

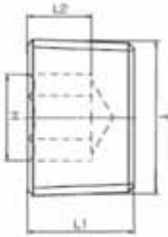
	REFERENCIA	T	PN(Bar)	L1	L2	H (Hex)	Peso Weight(g)	
	316							
	TAP.CON.-1M-316X	R1/8"	150	8,2	5	5	3	
	TAP.CON.-2M-316X	R1/4"	150	10,2	6	6	7,4	
	TAP.CON.-3M-316X	R3/8"	150	11,6	7	8	14	
	TAP.CON.-4M-316X	R1/2"	150	13,3	8	10	24,5	
	TAP.CON.-6M-316X	R3/4"	150	15	9	12	46,4	

Adaptador rosca macho cónica BSPT espiga para manguera • Male barb connector BSPT thread

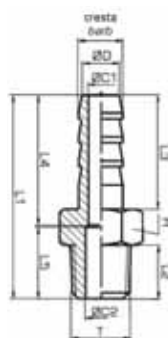
	REFERENCIA	T	ØD	L1	L2	L3	L4	L5	ØC1	ØC2	H (Hex)	Cresta barb	Peso Weight(g)		
	303														
	AD-1ME-X	R1/8"	6	34	9	19	22	12	4	5	12	7,2	13		
	AD-2ME-X	R1/4"	8	35,5	10,5	19	21	14,5	5,5	7	14	9,2	18		
	AD-2ME-10X	R1/4"	9	35,5	10,5	19	21	14,5	5,5	7	14	10	18		
	AD-2ME-11,5X	R1/4"	11	39,5	10,5	23	39,5	-	7,5	7,5	14	11,5	18		
	AD-3ME-X	R3/8"	10	41,5	11,5	23	26	15,5	8	10	17	11,2	26		
	AD-4ME-X	R1/2"	14	51	15	28	32,5	18,5	11	13	22	15,2	54		
	AD-6ME-X	R3/4"	20	65	18	37	41	24	14	18	27	21	119		
	316														
	AD-1ME-316X	R1/8"	6	34	9	19	22	12	4	5	13	7,2	13		
	AD-2ME-316X	R1/4"	8	35,5	10,5	19	21	14,5	5,5	7	14	9,2	18		
	AD-2ME-10-316X	R1/4"	9	39,5	10,5	19	21	14,5	5,5	7	14	10	18		
	AD-3ME-316X	R3/8"	10	41,5	11,5	23	26	15,5	8	10	17	11,2	26		
	AD-4ME-316X	R1/2"	14	51	15	28	32,5	18,5	11	13	22	15,2	54		
	AD-6ME-316X	R3/4"	20	65	18	37	41	24	14	18	27	21	119		

Datos Técnicos	
Aplicaciones	Neumática, industria química, alimentación, construcción naval, etc.
	Aplicación en ambientes corrosivos.
Materiales utilizados	Fabricados en acero inoxidable EN 1.4409 / 316 microfusión.
Rosca	Rosca hembra cilíndrica según norma ISO 228.
	Rosca macho cónica según norma ISO 7/1 - DIN 2999.
Presión de trabajo	20 Bar
Características	Soldable con los medios adecuados

Technical specifications	
Applications	Pneumatics, chemical, food, marine, etc.
	Application in corrosive environment.
Materials used	Stainless steel EN 1.4409 / 316 microfusion
Threads	Cylindrical BSPP ISO 228
	Taper gas BSPT ISO 7/1 - DIN 2999
Working pressure	20 BAR
Advantages	Weldable with appropriate means

Codo rosca hembra cilíndrica BSPP • Elbow female BSPP thread

FIGURA 90	REFERENCIA	ROSCA H	Peso Weight(g)
	F090018X	G1/8"	40
	F090014X	G1/4"	60
	F090038X	G3/8"	70
	F090012X	G1/2"	100
	F090034X	G3/4"	160
	F090100X	G1"	260
	F090114X	G1 1/4"	400
	F090112X	G1 1/2"	500
	F090200X	G2"	740
	F090212X	G2 1/2"	1.360
	F090300X	G3"	1.480
	F090400X	G4"	2.760

Codo rosca macho cónica BSPT - hembra cilíndrica BSPP • Elbow male BSPT - female BSPP thread

FIGURA 92	REFERENCIA	ROSCA M	ROSCA H	Peso Weight(g)
	F092018X	R1/8"	G1/8"	30
	F092014X	R1/4"	G1/4"	70
	F092038X	R3/8"	G3/8"	80
	F092012X	R1/2"	G1/2"	100
	F092034X	R3/4"	G3/4"	170
	F092100X	R1"	G1"	220
	F092114X	R1 1/4"	G1 1/4"	380
	F092112X	R1 1/2"	G1 1/2"	490
	F092200X	R2"	G2"	780
	F092212X	R2 1/2"	G2 1/2"	1.250
	F092300X	R3"	G3"	1.850
	F092400X	R4"	G4"	3.110

Codo 45° rosca hembra cilíndrica BSPP • Elbow 45° female BSPP thread

FIGURA 120	REFERENCIA	ROSCA H	Peso Weight(g)
	F120018X	G1/8"	40
	F120014X	G1/4"	50
	F120038X	G3/8"	80
	F120012X	G1/2"	100
	F120034X	G3/4"	150
	F120100X	G1"	220
	F120114X	G1 1/4"	340
	F120112X	G1 1/2"	420
	F120200X	G2"	620
	F120212X	G2 1/2"	1.130
	F120300X	G3"	1.250
	F120400X	G4"	2.100

"T" Igual rosca hembra cilíndrica BSPP • Female tee BSPP thread

FIGURA 130	REFERENCIA	ROSCA H	Peso Weight(g)
	F130018X	G1/8"	50
	F130014X	G1/4"	80
	F130038X	G3/8"	100
	F130012X	G1/2"	150
	F130034X	G3/4"	220
	F130100X	G1"	360
	F130114X	G1 1/4"	570
	F130112X	G1 1/2"	670
	F130200X	G2"	1.050
	F130212X	G2 1/2"	1.750
	F130300X	G3"	1.950
	F130400X	G4"	3.220

Cruz rosca hembra cilíndrica BSPP • H cross BSPP thread

FIGURA 180

NUEVO



REFERENCIA	ROSCA H	Peso Weight(g)
F180018X	G1/8"	0,038
F180014X	G1/4"	0,072
F180038X	G3/8"	0,103
F180012X	G1/2"	0,144
F180034X	G3/4"	0,249
F180100X	G1"	0,435
F180114X	G1 1/4"	0,701
F180112X	G1 1/2"	0,768
F180200X	G2"	1,258
F180212X	G2 1/2"	1,77
F180300X	G3"	2,031
F180400X	G4"	3,49

Tapón rosca macho cónica BSPT • Male plug BSPT thread

FIGURA 290



REFERENCIA	ROSCA M	Peso Weight(g)
F290018X	R1/8"	20
F290014X	R1/4"	30
F290038X	R3/8"	40
F290012X	R1/2"	50
F290034X	R3/4"	70
F290100X	R1"	120
F290114X	R1 1/4"	210
F290112X	R1 1/2"	300
F290200X	R2"	440
F290212X	R2 1/2"	710
F290300X	R3"	1.110
F290400X	R4"	1.980

Tapón rosca hembra cilíndrica BSPP • Female plug BSPP thread

FIGURA 300



REFERENCIA	ROSCA H	Peso Weight(g)
F300018X	G1/8"	20
F300014X	G1/4"	30
F300038X	G3/8"	40
F300012X	G1/2"	60
F300034X	G3/4"	70
F300100X	G1"	120
F300114X	G1 1/4"	230
F300112X	G1 1/2"	250
F300200X	G2"	490
F300212X	G2 1/2"	1.200
F300300X	G3"	1.770
F300400X	G4"	2.720

Entronque rosca macho cónica para soldar BSPT • Male BSPT welding end

FIGURA 149



REFERENCIA	ROSCA M	Peso Weight(g)
F149018X	R1/8"	10
F149014X	R1/4"	20
F149038X	R3/8"	30
F149012X	R1/2"	40
F149034X	R3/4"	60
F149100X	R1"	80
F149114X	R1 1/4"	130
F149112X	R1 1/2"	140
F149200X	R2"	220
F149212X	R2 1/2"	280
F149300X	R3"	710
F149400X	R4"	1.100

Entronque doble rosca macho cónica BSPT • Male union assembly BSPT thread

FIGURA 150	REFERENCIA	ROSCA M	Peso Weight(g)
	F150014X	R1/4"	20
	F150038X	R3/8"	30
	F150012X	R1/2"	60
	F150034X	R3/4"	70
	F150100X	R1"	110
	F150114X	R1 1/4"	190
	F150112X	R1 1/2"	220
	F150200X	R2"	390
	F150212X	R2 1/2"	500
	F150300X	R3"	720
	F150400X	R4"	880

Manguito reducción rosca hembra cilíndrica BSPP • Reduced socket f/f sleeve BSPP thread

FIGURA 240	REFERENCIA	ROSCA H1	ROSCA H2	Peso Weight(g)
	F240014018X	G1/4"	G1/8"	30
	F240038014X	G3/8"	G1/4"	50
	F240012038X	G1/2"	G3/8"	70
	F240034012X	G3/4"	G1/2"	120
	F240100034X	G1"	G3/4"	150
	F240114100X	G1 1/4"	G1"	230
	F240112114X	G1 1/2"	G1 1/4"	300
	F240200112X	G2"	G1 1/2"	450

Reducción rosca macho cónica BSPT - hembra cilíndrica BSPP • Reduced male BSPT - female BSPP

FIGURA 246	REFERENCIA	ROSCA M	ROSCA H	Peso Weight(g)
	F246018014X	R1/8"	G1/4"	20
	F246014038X	R1/4"	G3/8"	40
	F246038038X	R3/8"	G3/8"	40
	F246038012X		G1/2"	60
	F246012012X	R1/2"	G1/2"	70
	F246012034X		G3/4"	100
	F246034034X	R3/4"	G3/4"	100
	F246034100X		G1"	130
	F246100100X	R1"	G1"	140

Tuerca reducción rosca macho cónica BSPT - hembra cilíndrica BSPP • Reducing nut male BSPT - female BSPP

FIGURA 241	REFERENCIA	ROSCA M	ROSCA H	Peso Weight(g)
	F241014018X	R1/4"	G1/8"	10
	F241038018X	R3/8"	G1/8"	20
	F241038014X		G1/4"	10
	F241012014X	R1/2"	G1/4"	40
	F241012038X		G3/8"	30
	F241034038X	R3/4"	G3/8"	60
	F241034012X		G1/2"	50
	F241100012X	R1"	G1/2"	100
	F241100034X		G3/4"	80
	F241114012X	R1 1/4"	G1/2"	190
	F241114034X		G3/4"	170
	F241114100X		G1"	130
	F241112034X	R1 1/2"	G3/4"	310
	F241112100X		G1"	270
	F241112114X		G1 1/4"	200
	F241200100X	R2"	G1"	350
	F241200114X		G1 1/4"	360
	F241200112X		G1 1/2"	300
	F241212112X	R2 1/2"	G1 1/2"	650
	F241212200X		G2"	550
	F241300200X	R3"	G2"	1,030
	F241300212X		G2 1/2"	840

Machón reducido rosca macho cónica BSPT • Reduced nipple BSPT thread

FIGURA 245	REFERENCIA	ROSCA M1	ROSCA M2	Peso Weight(g)
	F245014018X	R1/4"	R1/8"	30
	F245038018X	R3/8"	R1/8"	40
	F245038014X	R3/8"	R1/4"	50
	F245012014X	R1/2"	R1/4"	50
	F245012038X	R1/2"	R3/8"	70
	F245034038X	R3/4"	R3/8"	80
	F245034012X	R3/4"	R1/2"	100
	F245100012X	R1"	R1/2"	120
	F245100034X	R1"	R3/4"	150
	F245114012X	R1 1/4"	R1/2"	210
	F245114034X	R1 1/4"	R3/4"	210
	F245114100X	R1 1/4"	R1"	220
	F245112034X	R1 1/2"	R3/4"	250
	F245112100X	R1 1/2"	R1"	270
	F245112114X	R1 1/2"	R1 1/4"	310
	F245200100X	R2"	R1"	340
	F245200114X	R2"	R1 1/4"	370
	F245200112X	R2"	R1 1/2"	430
	F245212200X	R2 1/2"	R2"	930
	F245300200X	R3"	R2"	1.030
F245300212X	R3"	R2 1/2"	1.360	

Manguito rosca hembra cilíndrica BSPP • Female BSPP sleeve

FIGURA 270	REFERENCIA	ROSCA H	Peso Weight(g)
	F270018X	G1/8"	20
	F270014X	G1/4"	30
	F270038X	G3/8"	40
	F270012X	G1/2"	60
	F270034X	G3/4"	80
	F270100X	G1"	140
	F270114X	G1 1/4"	230
	F270112X	G1 1/2"	270
	F270200X	G2"	460
	F270212X	G2 1/2"	810
	F270300X	G3"	1.440
	F270400X	G4"	2.170

Machón rosca macho cónica BSPT • Nipple BSPT thread

FIGURA 280	REFERENCIA	ROSCA M	Peso Weight(g)
	F280018X	R1/8"	10
	F280014X	R1/4"	20
	F280038X	R3/8"	30
	F280012X	R1/2"	50
	F280034X	R3/4"	80
	F280100X	R1"	120
	F280114X	R1 1/4"	230
	F280112X	R1 1/2"	260
	F280200X	R2"	400
	F280212X	R2 1/2"	720
	F280300X	R3"	880
	F280400X	R4"	1.870

Entronque manguera - rosca macho cónica BSPT • Hose adapter BSPT thread

FIGURA 399	REFERENCIA	ROSCA M	øEspiga	Peso Weight(g)
	F399018X	R1/8"	7	20
	F399014X	R1/4"	9	30
	F399038X	R3/8"	13	40
	F399012X	R1/2"	15	70
	F399034X	R3/4"	20	140
	F399100X	R1"	25	240
	F399114X	R1 1/4"	33	270
	F399112X	R1 1/2"	39	410
	F399200X	R2"	51	690

Manguito interior rosca macho cilíndrica BSPP • Internal BSPP male conector

FIGURA 531	REFERENCIA	ROSCA M	Peso Weight(g)
	F531014X	G1/4"	10
	F531038X	G3/8"	10
	F531012X	G1/2"	20
	F531034X	G3/4"	30
	F531100X	G1"	50
	F531114X	G1 1/4"	80
	F531112X	G1 1/2"	80
	F531200X	G2"	120
	F531212X	G2 1/2"	210
	F531300X	G3"	300
	F531400X	G4"	500

Contratuera rosca hembra cilíndrica BSPP • BSPP nut

FIGURA 312	REFERENCIA	ROSCA H	Peso Weight(g)
	F312018X	G1/8"	10
	F312014X	G1/4"	20
	F312038X	G3/8"	30
	F312012X	G1/2"	40
	F312034X	G3/4"	60
	F312100X	G1"	80
	F312114X	G1 1/4"	110
	F312112X	G1 1/2"	150
	F312200X	G2"	220

Curva puente - rosca hembra cilíndrica BSPP • Bended union BSPP thread

FIGURA 85	REFERENCIA	ROSCA H	Peso Weight(g)
	F085038X	G3/8"	130
	F085012X	G1/2"	190
	F085034X	G3/4"	270
	F085100X	G1"	510
	F085114X	G1 1/4"	900

Enlace 3 piezas con junta plana de PTFE - rosca hembra cilíndrica • 3 pieces pipe fitting union with PTFE gasket

FIGURA 330	REFERENCIA	ROSCA H	Peso Weight(g)
	F330018X	G1/8"	60
	F330014X	G1/4"	100
	F330038X	G3/8"	120
	F330012X	G1/2"	200
	F330034X	G3/4"	270
	F330100X	G1"	310
	F330114X	G1 1/4"	720
	F330112X	G1 1/2"	800
	F330200X	G2"	1.190
	F330212X	G2 1/2"	1.810
	F330300X	G3"	2.600
	F330400X	G4"	4.350

Enlace 3 piezas con asiento cónico - rosca hembra cilíndrica BSPP • 3 pieces pipe union fittings female BSPP

FIGURA 340	REFERENCIA	ROSCA H	Peso Weight(g)
	F340018X	G1/8"	50
	F340014X	G1/4"	100
	F340038X	G3/8"	120
	F340012X	G1/2"	210
	F340034X	G3/4"	270
	F340100X	G1"	320
	F340114X	G1 1/4"	720
	F340112X	G1 1/2"	800
	F340200X	G2"	1.190
	F340212X	G2 1/2"	2.050
	F340300X	G3"	2.590
	F340400X	G4"	4.300

Enlace 3 piezas con asiento cónico para soldar • 3 pieces pipe union fittings welding ends

FIGURA 340 S	REFERENCIA	∅ Interior (mm)	Para tubo ∅ exterior (")	Peso Weight(g)
	F340S018X	10,5	1/8"	100
	F340S014X	14,1	1/4"	100
	F340S038X	17,6	3/8"	130
	F340S012X	21,7	1/2"	200
	F340S034X	27,1	3/4"	260
	F340S100X	33,9	1"	410
	F340S114X	42,6	1 1/4"	610
	F340S112X	48,7	1 1/2"	770
	F340S200X	61,1	2"	1.180
	F340S212X	76,9	2 1/2"	1.770
	F340S300X	89,9	3"	2.510

Enlace 3 piezas con junta plana de PTFE - rosca macho cónica BSPT - hembra cilíndrica BSPP
3 pieces pipe union fittings with PTFE gasket - male BSPT - female BSPP

FIGURA 331	REFERENCIA	ROSCA M	ROSCA H	Peso Weight(g)
	F331018X	R1/8"	G1/8"	60
	F331014X	R1/4"	G1/4"	100
	F331038X	R3/8"	G3/8"	130
	F331012X	R1/2"	G1/2"	230
	F331034X	R3/4"	G3/4"	310
	F331100X	R1"	G1"	390
	F331114X	R1 1/4"	G1 1/4"	840
	F331112X	R1 1/2"	G1 1/2"	940
	F331200X	R2"	G2"	1.450
	F331212X	R2 1/2"	G2 1/2"	2.350
	F331300X	R3"	G3"	3.430
	F331400X	R4"	G4"	5.870

Enlace 3 piezas con asiento cónico - rosca macho cónica BSPT - hembra cilíndrica BSPP
3 pieces pipe union fittings - male BSPT - female BSPP

FIGURA 341	REFERENCIA	ROSCA M	ROSCA H	Peso Weight(g)
	F341018X	R1/8"	G1/8"	60
	F341014X	R1/4"	G1/4"	110
	F341038X	R3/8"	G3/8"	130
	F341012X	R1/2"	G1/2"	230
	F341034X	R3/4"	G3/4"	310
	F341100X	R1"	G1"	390
	F341114X	R1 1/4"	G1 1/4"	850
	F341112X	R1 1/2"	G1 1/2"	960
	F341200X	R2"	G2"	1.470
	F341212X	R2 1/2"	G2 1/2"	2.460
	F341300X	R3"	G3"	3.450
	F341400X	R4"	G4"	5.720

Adaptador rosca hembra cilíndrica BSPP-espiga para manguera • Female barb connector BSPT thread

FIGURA 599	REFERENCIA	ROSCA H	∅Espiga	Longitud	Hexágono	Peso Weight(g)
	F599018X	G1/8"	6,5	40	15	22
	F599014X	G1/4"	9	44	19	41
	F599038X	G3/8"	11	53	22	55
	F599012X	G1/2"	14	63	27	96
	F599034X	G3/4"	21	64	32	133
	F599100X	G1"	27	66	38	216
	F599114X	G1 1/4"	33	75	50	328
	F599112X	G1 1/2"	40	90	56	419
	F599200X	G2"	52	95	68	679

Adaptador rosca macho cónica BSPT-espiga para manguera • Male barb connector BSPT thread

FIGURA 601

REFERENCIA	ROSCA M	∅Espiga	Longitud	Peso Weight(g)
F601014X	R1/4"	13,5	52	34
F601038X	R3/8"	17,2	54	36
F601012X	R1/2"	21,3	54	57
F601034X	R3/4"	26,9	63	72
F601100X	R1"	33,7	66	149
F601114X	R1 1/4"	42,4	78	195
F601112X	R1 1/2"	48,3	78	263
F601200X	R2"	60,3	78	326
F599200X	G2"	52	95	68

Adaptador espiga-espiga para manguera • Hose union adaptor

FIGURA 602

REFERENCIA	∅Espiga	Longitud	Peso Weight(g)
F60213X	13,5	70	47
F60217X	17,2	70	50
F60221X	21,3	70	71
F60226X	26,9	80	97
F60233X	33,7	80	186
F60242X	42,4	95	254
F60248X	48,3	95	360
F60260X	60,3	95	429

Racor espiga para manguera con tuerca giratoria rosca cilíndrica BSPP • Hose adaptor with nut female thread BSPP

FIGURA 603

REFERENCIA	ROSCA H	∅Espiga	Longitud	Hexágono	Peso Weight(g)
F603038X	G3/8"	13	28	14	50
F603012X	G1/2"	15	30	17	58
F603034X	G3/4"	20	35	20	89
F603100X	G1"	25	40	24	156
F603114X	G1 1/4"	33	47	27	198
F603112X	G1 1/2"	39	68	31	366
F603200X	G2"	51	82	40	665

Filtro en "Y" - Rosca hembra cilíndrica BSPP - PN 40 bar • "Y" strainer - PN 40 bar

FILTRO EN "Y"

REFERENCIA	ROSCA H	PN (bar)	Longitud	Hexágono	Peso Weight(g)
FY014-X	G1/4"	40	65	24	233
FY038-X	G3/8"	40	65	24	233
FY012-X	G1/2"	40	60	27	245
FY034-X	G3/4"	40	69	33	365
FY100-X	G1"	40	85	42	700
FY114-X	G1 1/4"	40	99	49	950
FY112-X	G1 1/2"	40	111	56	1.179
FY200-X	G2"	40	137	69	1.837

Designación de la referencia - Model designation

DIS DISL DISDB	1H	22 22	21 41
Código Code	Entrada:Rosca Inlet: Thread size	Entrada:Rosca Inlet: Thread size	Nº Salidas Holes Nº
	Cilíndrica BSPP BSPP thread	Cilíndrica BSPP BSPP thread	Código DISL DISL Code
	1H G1/8"	22 G1/4"	21 2x1/8
	2H G1/4"	23 G3/8"	31 3x1/8
	3H G3/8"	24 G1/2"	41 4x1/8
	4H G1/2"		51 5x1/8
			61 6x1/8
			22 2x1/4
			32 3x1/4
			42 4x1/4
			52 5x1/4
			62 6x1/4
			23 2x3/8
			33 3x3/8
			43 4x3/8
			53 5x3/8
			63 6x3/8
			34 3x1/2
			44 4x1/2
			54 5x1/2
			64 6x1/2
			Código DISDB DISDB Code
			41 2+2x1/8
			61 3+3x1/8
			81 4+4x1/8
			101 5+5x1/8
			42 2+2x1/4
			62 3+3x1/4
			82 4+4x1/4
			102 5+5x1/4
			43 2+2x3/8
			63 3+3x3/8
			83 4+4x3/8

Datos Técnicos	
Aplicaciones	Neumática, lubricación, etc
Materiales utilizados	Cuerpo: aluminio
Rosca	Gas cilíndrica BSPP
Presión de trabajo	20 Bar
Temperatura de trabajo	De -10°C a +80°C
Tratamiento	Natural
Producto conforme a la directiva 2002/95/EC 	

Technical specifications	
Applications	Pneumatics & lubrication
Materials used	Body: aluminium
Threads	Cylindrical gas BSPP
Working pressure	20 Bar
Working temperatura	From -10°C to +80°C
Treatment	Natural
Products in conformity with the directive 2002/95/EC 	

Distribuidor de aluminio en cruz • Aluminium tee cross

DIS-H	REFERENCIA	A	B	C	D	E	Peso Weight(g)
	DIS-1H	G1/8"	25	16	4,5	17	17,5
	DIS-2H	G1/4"	40	20	5,5	26	60
	DIS-3H	G3/8"	40	25	5,5	26	70
	DIS-4H	G1/2"	50	30	5,5	34	129

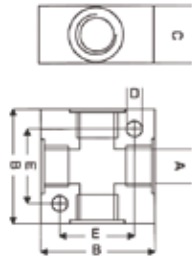

Regleta distribución sencilla de aluminio • Aluminium single distribution manifold

DISL	REFERENCIA	A	B	C	D	E	F	G	H (Hex)	L	Peso Weight(g)
	DISL-22-21	G1/4"	G1/8"-2	30	20	54	18	4,5	45	4,5	64
	DISL-22-31		G1/8"-3			72			63		86
	DISL-22-41		G1/8"-4			90			81		110
	DISL-22-51		G1/8"-5			108			99		130
	DISL-22-61		G1/8"-6			126			117		154
	DISL-23-22	G3/8"	G1/4"-2	40	25	68	24	6	51	5,5	136
	DISL-23-32		G1/4"-3			92			75		184
	DISL-23-42		G1/4"-4			116			99		238
	DISL-23-52		G1/4"-5			140			123		298
	DISL-23-62		G1/4"-6			164			147		338
	DISL-24-23	G1/2"	G3/8"-2	50	30	78	26	6,5	59	5,5	228
	DISL-24-33		G3/8"-3			104			85		304
	DISL-24-43		G3/8"-4			130			111		380
	DISL-24-53		G3/8"-5			156			137		456
	DISL-24-63		G3/8"-6			182			163		530
	DISL-24-34	G1/2"	G1/2"-3	50	30	136	34	6,5	117	5,5	392
	DISL-24-44		G1/2"-4			170			151		488
	DISL-24-54		G1/2"-5			204			185		584
	DISL-24-64		G1/2"-6			238			219		682

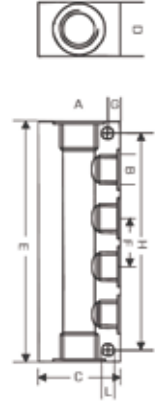

Regleta distribución doble de aluminio • Aluminium double distribution manifold

DISDB	REFERENCIA	A	B	C	D	E	F	G	H (Hex)	L	I	Peso Weight(g)
	DISDB-22-41	G1/4"	G1/8"-2+2	30	20	54	18	4,5	45	4,5	21	60
	DISDB-22-61		G1/8"-3+3			72			63			81
	DISDB-22-81		G1/8"-4+4			90			81			100
	DISDB-22-101		G1/8"-5+5			108			99			122
	DISDB-23-42	G3/8"	G1/4"-2+2	40	25	68	24	6	51	5,5	28	127
	DISDB-23-62		G1/4"-3+3			92			75			170
	DISDB-23-82		G1/4"-4+4			116			99			216
	DISDB-23-102		G1/4"-5+5			140			123			266
	DISDB-24-43	G1/2"	G3/8"-2+2	50	30	78	26	6,5	59	5,5	37	210
	DISDB-24-63		G3/8"-3+3			104			85			278
	DISDB-24-83		G3/8"-4+4			130			111			344

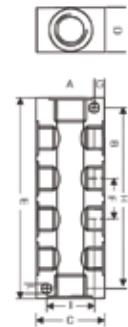

Consultar disponibilidad en acero INOX.

Consultar disponibilidad en otras medidas de las referencias (DISL - DISDB)

RACORES ROSCADOS Y ESPIGAS EN MATERIAL FDA THREADED FITTINGS AND BARB CONNECTORS IN FDA MATERIALS

Consultar disponibilidad de fabricación de racores roscados y de espiga, en materiales con certificación FDA:
 -Nylon de alta resistencia

Para aplicaciones en laboratorios, instrumentación analítica, química, farmacéutica y equipos médicos.

Producto conforme a la directiva 2002/95/EC 

Producto conforme a la directiva 1907/2006 



Check availability threaded fittings manufacturing and barb connectors, in materials with FDA certification:
 - High strength nylon

For applications in laboratories, analytical instrumentation, chemical, pharmaceutical and medical equipment.

Products in conformity with the directive 2002/95/EC 

Products in conformity with the directive 1907/2006 





VÁLVULAS DE ESFERA · Ball Valves

MICROVÁLVULAS DE ESFERA EN LATÓN · Brass micro ball valves

MINIVÁLVULAS DE ESFERA EN LATÓN · Brass mini ball valves

VÁLVULAS DE ESFERA EN LATÓN · Brass ball valves

VÁLVULAS DE ESFERA EN LATÓN MANDO MARIPOSA

Brass ball valves - butterfly handle

GRIFO DE ESFERA EN LATÓN PARA MANGUERA

Ball bibcock with hose conector

MINIVÁLVULAS DE ESFERA EN INOX. AISI 316 · Mini ball valves INOX AISI 316

VÁLVULAS DE ESFERA EN INOX. AISI 316 · Ball valves INOX AISI 316

VÁLVULAS DE ESFERA EN INOX. AISI 316 MICROFUSIÓN

Ball valves INOX AISI 316 microfusion

AISI 316

AISI 316

Datos Técnicos	
Aplicaciones	Circuitos neumáticos, hidráulicos y oleodinámicos. Las válvulas pueden usarse, incluso para medio/bajo vacío.
Materiales utilizados	Cuerpo en latón EN 12165 CW 617 N
	Esfera en latón EN 12165 CW 617 N
	Maneta en PA 66
	Tornillo en acero
	Eje en latón EN 12164 CW 614 N
	Guarnición asiento esfera PTFE
	Junta tórica NBR 70
Tratamiento superficial	Cromado
Roscas	Gas cónica ISO 7-DIN 2999
	Gas cilíndrica ISO 228
Presión máxima de trabajo	20 Bar
Temperatura de trabajo	De -18°C a + 80 °C
Tubos utilizados	Poliamida (PA)
	Poliuretano (PU)

Technical specifications	
Applications	Compressed air, and hydraulic circuits. they can also be used for medium/low vacuum
Materials used	Body: brass EN 12165 CW 617 N
	Ball brass EN 12165 CW 617 N
	Handle PA 66
	Screw steel
	Stem brass EN 12164 CW 614 N
	Washers ball seat PTFE
	O'ring NBR 70
Surface treatment	Chromium plating
Threads	Tapered gas ISO 7 - DIN 2999
	Cylindrical gas ISO 228
Max. working pressure	20 bar
Working temperature	from -18°C to + 80 °C
Tubes used	Polyamide (PA)
	Polyurethane (PU)

Los datos técnicos y gráficos no son vinculantes. - Drawing and technical date are not binding.

Microválvula de esfera en latón rosca hembra • Brass micro ball valve female

MICROVAL H	REFERENCIA	ROSCA H	Diámetro nominal (mm)	Longitud total (mm)	Peso Weight(g)
	MICROVAL1H	G1/8"	5,5	36,5	35
	MICROVAL2H	G1/4"	5,5	43	39

Microválvula de esfera en latón rosca hembra - macho • Brass micro ball valve female - male

MICROVAL H M	REFERENCIA	ROSCA M	ROSCA H	Diámetro nominal (mm)	Longitud total (mm)	Peso Weight(g)
	MICROVAL1H-1M	R1/8"	G1/8"	5,5	35,5	32
	MICROVAL2H-2M	R1/4"	G1/4"	5,5	40,5	36
	MICROVAL2H-3M	R3/8"	G1/4"	5,5	41,5	51
	MICROVAL3H-3M		G3/8"	7	48	

Microválvula de esfera en latón rosca macho - tubo • Brass micro ball valve male - push in fitting

MICROVAL M	REFERENCIA	∅ Tubo (mm)	ROSCA M	Diámetro nominal (mm)	Longitud total (mm)	Peso Weight(g)
	MICROVAL4-1M	4	R1/8"	5,5	41	36
	MICROVAL4-2M		R1/4"	5,5	44	40
	MICROVAL6-1M	6	R1/8"	5,5	41	37
	MICROVAL6-2M		R1/4"	5,5	44	41
	MICROVAL6-3M		R3/8"	5,5	45	45
	MICROVAL8-2M	8	R1/4"	5,5	48	47
MICROVAL8-3M	R3/8"		5,5	48,5	52	

Microválvula de esfera en latón tubo - tubo • Brass micro ball valve push in fitting

MICROVAL	REFERENCIA	∅ Tubo (mm)	Longitud total (mm)	Peso Weight(g)
	MICROVAL4	4	43	40
	MICROVAL6	6	43	48
	MICROVAL8	8	47,5	56

Datos Técnicos	
Aplicaciones	Circuitos neumáticos, hidráulicos y oleodinámicos. Las válvulas pueden usarse, incluso para medio/bajo vacío
Materiales utilizados	Cuerpo en latón DIN 17660.
	Maneta en aluminio lacado.
	Tornillo en acero.
	Eje en latón.
	Guarnición asiento esfera PTFE.
	Junta tórica NBR 70.
Tratamiento superficial	Cromado
Roscas	Gas cilíndrica ISO 228
Presión máxima de trabajo	16 Bar.
Temperatura de trabajo	Hasta 140 °C





Technical specifications	
Applications	Compressed air, and hydraulic circuits. they can also be used for medium/low vacuum
Materials used	Body: brass DIN 17660
	Handle in aluminium lacquered
	Screw stell
	Stem brass
	Washers ball seat PTFE
	O'ring NBR 70
Surface treatment	Chromium plating
Threads	Cylindrical gas ISO 228
Max. working pressure	16 bar.
Working temperature	Up to 140 °C

Los datos técnicos y gráficos no son vinculantes. - Drawing and technical date are not binding.

Miniválvula de esfera en latón rosca hembra • Brass mini ball valve female					
MINIVAL H	REFERENCIA	ROSCA H	Diámetro nominal (mm)	Longitud total (mm)	Peso Weight (g)
	M.VAL-1H	G1/8"	7	39	88
	M.VAL-2H	G1/4"	8	39	94
	M.VAL-3H	G3/8"	8	42	91
	M.VAL-4H	G1/2"	10	47	110
	M.VAL-6H	G3/4"	12	54	194

Miniválvula de esfera en latón rosca hembra - macho • Brass mini ball valve female - male						
MINIVAL H M	REFERENCIA	ROSCA M	ROSCA H	Diámetro nominal (mm)	Longitud total (mm)	Peso Weight (g)
	M.VAL-1H-1M	G1/8"	G1/8"	6	39	80
	M.VAL-2H-2M	G1/4"	G1/4"	8	39	78
	M.VAL-3H-3M	G3/8"	G3/8"	8	40	74
	M.VAL-4H-4M	G1/2"	G1/2"	10	45	108
	M.VAL-6H-6M	G3/4"	G3/4"	12	51	177

Miniválvula de esfera en latón rosca macho - macho • Brass mini ball valve male - male					
MINIVAL M M	REFERENCIA	ROSCA	Diámetro nominal (mm)	Longitud total (mm)	Peso Weight (g)
 NUEVO	M.VAL-2M-2M	G1/4"	8,2	40,4	62
	M.VAL-3M-3M	G3/8"	12,2	42,4	64
	M.VAL-4M-4M	G1/2"	15,2	49,7	108

Manetas de colores para miniválvula de esfera • Coloured lever for mini ball valve		
MANETAS	REFERENCIA	Colores
	MANETA-AZ	
	MANETA-AM	
	MANETA-RO	

Datos Técnicos	
Aplicaciones	Circuitos neumáticos, hidráulicos y oleodinámicos. Las válvulas pueden usarse, incluso para medio/bajo vacío.
Materiales Utilizados	Cuerpo en latón DIN 17660
	Esfera en latón cromado
	Maneta en acero cromado
	Funda de maneta en vinilo
	Tuerca del eje en latón cromado
	Eje en latón cromado
	Guarnición asiento esfera PTFE
	Junta tórica NBR
Tratamiento superficial	Cromado
Roscas	Gas cilíndrica ISO 228
Presión de trabajo	25 Bar
Temperatura de trabajo	Hasta 180 °C

Technical specifications	
Applications	Compressed air, and hydraulic circuits. They can also be used for medium/low vacuum
Materials used	Body brass DIN 17660
	Ball brass chromed.
	Handle in steel chromed.
	Handle sleeve: vinyl.
	Nut brass chromed.
	Stem brass chromed.
	Washers ball seat PTFE.
	O-ring NBR
Surface treatment	Chromium plating
Threads	Cylindrical gas ISO 228
Working pressure	25 bar
Working temperature	Up to 180 °C.

Los datos técnicos y gráficos no son vinculantes. - Drawing and technical date are not binding.



Válvula de esfera en latón rosca hembra • Brass ball valve female



VAL H	REFERENCIA	ROSCA H	Diámetro nominal (mm)	Longitud total (mm)	Peso Weight(g)
	VAL-14H	G1/4"	10	43	120
	VAL-38H	G3/8"	10	43	120
	VAL-12H	G1/2"	15	50	155
	VAL-34H	G3/4"	20	56	260
	VAL-01H	G1"	25	68	390
	VAL-0114H	G1 1/4"	32	80	620
	VAL-0112H	G1 1/2"	40	89	865
	VAL-02H	G2"	50	104	1.365
	VAL-0212H	G2 1/2"	65	137	2.490
	VAL-03H	G3"	80	158	4.125

Datos Técnicos	
Presión Nominal	25 Bar
Conexión hembra-hembra y hembra macho	
Mando de mariposa	
Materiales utilizados	Palanca de aluminio.
	Cuerpo en latón CW614N (UNE EN 12164-12165) niquelado.
	Bola cromada-plateada pulida.
	Junta de cierre en PTFE
Temperatura máxima de trabajo	150 °C a 10 bar
	80 °C a 25 bar
Temperatura mínima de trabajo	-20 °C
Roscas	Gas s/ ISO 228/1
Alta fiabilidad	
Cierre rápido con 1/4 de vuelta	

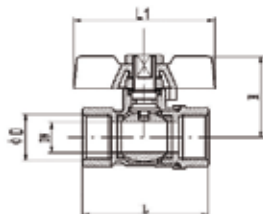
Technical specifications	
PN	25 Bar
Threaded ends F/F - F/M	
Butterfly handle	
Materials used	Aluminium handle
	Body in brass CW614N (UNE EN 12164-12165) nickel plated
	Ball polished chromed plated
	Sealing joint PTFE
Max. working temperature	150 °C a 10 bar.
	80 °C a 25 bar.
Min. working temperature	-20 °C
Threads	M-f threads according to iso228/1
High reliability	
Fast close (1/4 turn)	

Los datos técnicos y gráficos no son vinculantes. - Drawing and technical data are not binding.

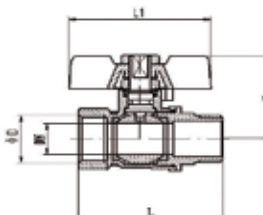
Válvula de esfera en latón rosca hembra BSPP - mando de mariposa • Ball valves in brass BSPP/F - butterfly lever								
VALMAR H	REFERENCIA	ROSCA H ØD	DN (mm)	L (mm)	H (mm)	L1 (mm)	Peso Weight (g)	
	VALMAR12H	G1/2"	13,5	46	35	54	122	
	VALMAR34H	G3/4"	17	52	37,5	54	171	
	VALMAR01H	G1"	21,5	60	48,5	70	274	

Válvula de esfera en latón rosca hembra BSPP-macho BSPT - mando de mariposa • Ball valves in brass BSPP/F BSPT/M - butterfly lever									
VALMAR H M	REFERENCIA	ROSCA H ØD	ROSCA M ØD	DN (mm)	L (mm)	H (mm)	L1 (mm)	Peso Weight (g)	
	VALMAR12H-12M	G1/2"	R1/2"	13,5	53	35	54	144	
	VALMAR34H-34M	G3/4"	R3/4"	17	58,5	37,5	54	194	
	VALMAR01H-01M	G1"	R1"	21,5	67,5	48,5	70	314	

Datos Técnicos

Presión nominal 16 Bar

Maneta de acero con recubrimiento de plástico

Fabricada en latón OT-58 cromado

Juntas en PTFE

Rosca gas cilíndrica

Technical specifications

PN 16 Bar

Lever in steel plastic coated

Body in brass OT-58 nickel plated

Seat in PTFE

Male thread BSPP/M

Los datos técnicos y gráficos no son vinculantes. - Drawing and technical data are not binding.

Grifo de esfera rosca macho cilíndrica BSPP con salida para manguera • Ball bibcock with hose connector male thread BSPP/M

VALGRIF M

REFERENCIA

ROSCA M

Diámetro nominal
(mm)

Longitud total (mm)

Peso Weight(g)

VALGRIF12M

G1/2"

5,5

36,5

35

VALGRIF34M

G3/4"

5,5

43



39





Datos Técnicos	
Aplicaciones	Circuitos neumáticos y conducciones de fluidos en general en industria alimentaria, farmacéutica, química, etc.
Las válvulas pueden usarse para aplicaciones de vacío	
Materiales utilizados	Cuerpo en AISI 316 pulido
	Esfera en AISI 316
	Maneta en aluminio lacado
	Tornillo en AISI 304
	Eje en AISI 304
	Guarnición asiento esfera PTFE + FV
	Junta tórica FKM
Tratamiento superficial	Pulido
Roscas	Gas cilíndrica DIN 2999
Presión máxima de trabajo	63 Bar
Temperatura de trabajo	De -25 °C a + 180 °C

Technical specifications	
Applications	Pneumatic applications and general fluid conductions in food, chemical, pharmacy, etc.
Suitable in vaccum applications	
Materials used	Body in AISI 316 polished
	Ball in AISI 316
	Handle in aluminium
	Screw in AISI 304
	Stem in AISI 304
	Washers ball seat PTFE + GF
	O'ring FKM
Surface treatment	Polished
Threads	Cylindrical DIN 2999
Max. working pressure	63 bar
Working temperature	From -25 °C to + 180 °C

Los datos técnicos y gráficos no son vinculantes. - Drawing and technical date are not binding.

Miniválvula de esfera en acero inox. AISI 316 rosca hembra • Mini ball valve in AISI 316 female					
M.VAL H X	REFERENCIA	ROSCA H	Diámetro nominal (mm)	Longitud total (mm)	Peso Weight(g)
	M.VAL-2H-X	G1/4"	8	42	104
	M.VAL-3H-X	G3/8"	8	42	92
	M.VAL-4H-X	G1/2"	10	46	125
	M.VAL-6H-X	G3/4"	12	54	211
					

Miniválvula de esfera en acero inox. AISI 316 rosca hembra - macho • Mini ball valve in AISI 316 female - male						
M.VALH M X	REFERENCIA	ROSCA M	ROSCA H	Diámetro nominal (mm)	Longitud total (mm)	Peso Weight(g)
	M.VAL-2H-2M-X	R1/4"	G1/4"	8	40	83
	M.VAL-3H-3M-X	R3/8"	G3/8"	8	40	82
	M.VAL-4H-4M-X	R1/2"	G1/2"	10	46	116
	M.VAL-6H-6M-X	R3/4"	G3/4"	12	54	193
						

Datos Técnicos	
Aplicaciones	Circuitos neumáticos, hidráulicos y oleodinámicos. Las válvulas pueden usarse, incluso para medio/bajo vacío.
Materiales utilizados	Cuerpo y tapa en AISI 316.
	Esfera en AISI 316.
	Maneta en AISI 304.
	Funda de maneta en vinilo.
	Tuerca del eje en AISI 304.
	Eje en AISI 316.
	Guarnición asiento esfera PTFE.
	Junta en PTFE.
Roscas	Gas cilíndrica DIN 2999
Presión máxima de trabajo	63 Bar
Temperatura de trabajo	De -25 °C a + 180 °C

Technical specifications	
Applications	Compressed air, and hydraulic circuits. they can also be used for medium/low vacuum
Materials used	Body and cap in AISI 316.
	Ball in AISI 316.
	Handle in AISI 304.
	Handle sleeve in vinyl.
	Nut in AISI 304.
	Stem in AISI 316.
	Washers ball seat PTFE.
	Gasket PTFE
Threads	Cylindrical gas DIN 2999
Max. working pressure	63 bar
Working temperature	From -25 to + 180 °C

Los datos técnicos y gráficos no son vinculantes. - Drawing and technical date are not binding.

Válvula de esfera en acero inox. AISI 316 pulido rosca hembra • Stainless steel ball valve AISI 316 polished female

VAL H X	REFERENCIA	ROSCA H	Diámetro nominal (mm)	Longitud total (mm)	Peso Weight(g)
	VAL-38H-X	G3/8"	7	45	108

AISI 316

Datos Técnicos	
Aplicaciones	Circuitos neumáticos y conducciones de fluidos en general en industria alimentaria, farmacéutica, química, etc.
Las válvulas pueden usarse para aplicaciones de vacío	
Materiales utilizados	Cuerpo y tapa en AISI 316 microfusión.
	Esfera en AISI 316.
	Maneta en AISI 304, recubierta de plástico.
	Tuerca del eje en AISI 304.
	Eje en AISI 316.
	Guarnición asiento esfera PTFE + 15 % FV.
	Junta en PTFE.
Roscas	Gas cilíndrica DIN 259 / 2999
Presión máxima de trabajo	69 Bar
Temperatura de trabajo	De -15 °C a + 180 °C

Technical specifications	
Applications	Pneumatic applications and general fluid conductions in food, chemical, pharmacy, etc. suitable in vaccum
Suitable in vaccum applications	
Materials used	Body and cap in AISI 316 microfusion.
	Ball in AISI 316.
	Handle in aisi 304.
	Nut in AISI 304.
	Stem in AISI 316.
	Washers ball seat PTFE + 15 % GF.
	Gasket PTFE.
Threads	Cylindrical gas DIN 259 / 2999
Max. working pressure	69 bar
Working temperature	From -15 °C to + 180 °C

Los datos técnicos y gráficos no son vinculantes. - Drawing and technical date are not binding.

Válvula esfera 2 piezas AISI 316 microfusión rosca hembra • Ball valve 2 pieces in AISI 316 microfusion female					
VAL HX D	REFERENCIA	ROSCA H	Diámetro nominal (mm)	Longitud total (mm)	Peso Weight(g)
	VAL-014HX-D	G1/4"	11,6	49	270
	VAL-038HX-D	G3/8"	12,7	49	270
	VAL-012HX-D	G1/2"	15	57	320
	VAL-034HX-D	G3/4"	20	65	500
	VAL-100HX-D	G1"	25	78	820
	VAL-114HX-D	G1 1/4"	32	90,5	990
	VAL-112HX-D	G1 1/2"	38	105	2.600
	VAL-200HX-D	G2"	50	127	3.100
	VAL-212HX-D	G2 1/2"	65	160	6.470
	VAL-300HX-D	G3"	80	187	10.750





ELECTROVÁLVULAS · Solenoid Valves

AISI 316

ELECTROVÁLVULAS INOX AISI 316 L · Solenoid valves INOX AISI 316 L

ELECTROVÁLVULAS INOX AISI 316L DE ACCIONAMIENTO DIRECTO 2/2 VIAS Y 3/2 VIAS SOLENOID VALVES INOX AISI 316L 2/2 WAYS & 3/2 WAYS DIRECT ACTING

Designación de la referencia - Model designation

SV	X	C	2	C	30	C	18										
Código	X: INOX	Serie Compacta Si se omite: Standard	2: 2 Vías 2/2 3: 3 Vías 3/2	C: Normalmente cerrada	DN : 15 DIAM. 1,5 25 DIAM. 2,5 30 DIAM. 3 40 DIAM. 4 50 DIAM. 5 64 DIAM. 6,4 100 DIAM. 10	Rosca	Tipo de rosca Thread size										
Code		Compact series If omitted: Standard	2: Ways 3/2 3: Ways 3/2	C: Normally closed		Thread BSPP	<table border="1"> <tr> <td colspan="2">Cilíndrica BSPP BSPP thread</td> </tr> <tr> <td>18</td> <td>G1/8"</td> </tr> <tr> <td>14</td> <td>G1/4"</td> </tr> <tr> <td>38</td> <td>G3/8"</td> </tr> <tr> <td>12</td> <td>G1/2"</td> </tr> </table>	Cilíndrica BSPP BSPP thread		18	G1/8"	14	G1/4"	38	G3/8"	12	G1/2"
Cilíndrica BSPP BSPP thread																	
18	G1/8"																
14	G1/4"																
38	G3/8"																
12	G1/2"																

Datos Técnicos	
Aplicaciones	Neumática, agua, alimentos, productos químicos, vacío y aplicaciones en industrias de alimentación, química, médica, farmacéuticas, etc..
Roscas	Cilíndricas ISO 228 desde 1/8" a 1 1/2"
Presión de trabajo	Ver tablas
Temperatura del fluido	Desde -10°C hasta +150°C
Temperatura ambiente	Desde -10°C hasta +80°C
Máxima viscosidad fluido	2° E (Grados Engler)
Características	<p>Eletroválvula de accionamiento directo tipo 2/2 NC y 3/2 NC para fluidos neutros compatibles con Juntas (FKM) alimentario y de acero INOX AISI 316L.</p> <p>No es necesaria una presión mínima de trabajo.</p> <p>Sellado entre el cuerpo y la armadura mediante soldadura que garantiza fiabilidad y duración en el tiempo.</p>
Materiales	<p>Cuerpo: acero INOX AISI 316L</p> <p>Asiento: acero INOX AISI 316L</p> <p>Núcleo móvil en acero INOX IMRE</p> <p>Tubo de armadura: acero inoxidable</p> <p>Muelle: acero inoxidable</p> <p>Protección: IP 65 con conector</p> <p>Conexión: según DIN 43650/A DIN 43650/B</p> <p>Bobina: con protección de poliarilamida IXEF</p> <p>Aislamiento del hilo 180°C clase H</p> <p>12-24 V DC</p> <p>24 110 220 240 V - AC 50/60 Hz</p> <p>Voltajes especiales bajo pedido.</p> <p>Tolerancias de la tensión: Para AC -10% +5% Volt</p> <p>Para DC -5% +10% Volt</p> <p>Junta tórica : Vitón FKM alimentario</p>
Bajo pedido	<p>EPDM (-20°C +145°C)</p> <p>PTFE grafitada al 25% (-40°C +200°C) excepto SVX2C100G12, SVX3C15G18, SVX3C25G14, SVX3C40G14</p>
Producto conforme a la directiva 2002/95/EC 	

Technical specifications	
Applications	Pneumatics, water, food, chemical, vacuum, medical & pharmaceutical applications
Threads	Cylindrical gas ISO 228 from 1/8" to 1/2"
Working pressure	See technical table
Fluid temperature	From -10°C to +150°C
Room temperature	From -10°C to +80°C
Maximum fluid viscosity	2° E (Engel degrees)
Advantages	<p>The solenoid valves are direct 2/2 acting valves & 3/2 ways NC.</p> <p>They are compatible with neutral liquids suitable for food Viton (FKM) NSF & stainless steel INOX AISI 316L.</p> <p>It's not necessary a minimum working pressure.</p> <p>The ealing o'ring between body & armature tube, 360° welding of the armature tube with core guarantee reliability & endurance</p>
Materials used	<p>Body: stainless steel AISI 316L</p> <p>Seat: stainless steel AISI 316L</p> <p>Armature tube: stainless steel</p> <p>Armature & core: stainless steel IMRE</p> <p>Springs: stainless steel</p> <p>Protection: IP 65 with connector</p> <p>Connection type: DIN 43650/A</p> <p>DIN 43650/B</p> <p>Coil: IXEF cover,</p> <p>Wire insulation 180°C class H</p> <p>12-24 V DC</p> <p>24 110 220 240 AC V - AC 50/60 Hz</p> <p>Special voltages on demand</p> <p>Voltage tolerances: AC -10% + 5% Volt</p> <p>DC -5% +10% Volt</p> <p>Standard seal material: food Viton FKM</p>
On demand	<p>EPDM (-20°C +145°C)</p> <p>PTFE 25% carbon charged (-40°C +200°C) except SVX2C100G12, SVX3C15G18, SVX3C25G14, SVX3C40G14</p>
Products in conformity with the directive 2002/95/EC 	

Los datos técnicos y gráficos no son vinculantes. - Drawing and technical date are not binding.

ELECTROVÁLVULAS INOX AISI 316L - SOLENOID VALVES INOX AISI 316L

Designación de la referencia - Model designation

Bobina - Coil

S	H	10	AC24
Bobina Coil	Clase Class	Tamaño 10: Pequeño 14: Grande 14/B: Bajo consumo	Tensión Voltaje DC 12 V DC 24 V AC 24 V AC 110 V AC 220 V AC 240 V
		Size 10: Small 14: Big 14/B: Low absorbing	

Conector - Connector

CN	10
Conector Connector	Tamaño 10: Pequeño 14: Grande 14/B: Bajo consumo
	Size 10: Small 14: Big 14/B: Low absorbing



Ej. / Ex. : SH14AC220



Ej. / Ex. : CN10

ELECTROVÁLVULAS - SOLENOID VALVES

SERIE Model	TIPO Type	CÓDIGO Code	ROSCA Size	DN mm	Kv m ³ /h	Presión trabajo (Bar)			T _a Temp. amb. °C	Potencia (absorción) power (absorption)		BOBINA Coil			CONECTOR Connector		ESTANQUEIDAD ALTERNATIVA Seal alternative			PESO tot Weight Kg
						Min.	Max.			VaAC	WDC	SH10	SH14	SH14/B	CN10	CN14	EPDM	PTFE	RUBI- NO	
							AC	DC												
COMPACT	22NC	SVXC2C 15G18	G1/8"	1,5	0,07	0	15	15	60°	14	9	•			•					0,378
		SVXC2C 15G14	G1/4"	1,5	0,07	0	15	15	60°	14	9	•			•					0,405
		SVXC2C 30G18	G1/8"	3	0,2	0	6	4	60°	14	9	•			•					0,4
		SVXC2C 30G14	G1/4"	3	0,2	0	6	4	60°	14	9	•			•					0,4
STANDARD	22NC	SVX2C 15G18	G1/4"	1,5	0,07	0	25	20	80°	22	12			•		•	•	•	•	0,378
		SVX2C 30G18	G3/8"	3	0,2	0	16	12	80°	22	12		•		•	•	•	•	•	0,378
		SVX2C 25G14	G1/4"	2,5	0,12	0	20	12	80°	22	12			•		•	•	•	•	0,378
		SVX2C 40G14	G1/8"	4	0,39	0	15/7	8/6	60-80°	34-22	17-12		•	•		•	•	•	•	0,4
		SVX2C 50G38	G1/8"	5	0,48	0	10/5	5/2	60-80°	34-22	17-12		•	•		•	•	•	•	0,404
		SVX2C 64G38	G3/8"	6,4	0,68	0	7/3	4/1,5	60-80°	34-22	17-12		•	•		•	•	•	•	0,404
		SVX2C 64G12	G1/2"	6,4	0,68	0	7/3	4/1,5	60-80°	34-22	17		•	•		•	•	•	•	0,378
		SVX2C 100G12	G1/2"	10	1,65	0	10	6	60°	34	17		•			•				0,515
STANDARD	32NC	SVX3C1 5G18	G1/8"	1,5	0,07	0	18	18	80°	22	12			•		•	•	•	•	0,405
		SVX3C 25G14	G1/4"	2,5	0,12	0	10	10	80°	22	12			•		•	•	•	•	0,4
		SVX3C 40G14	G1/4"	4	0,39	0	4	4	80°	22	12			•		•	•	•	•	0,4

NOTA: En DC la temperatura ambiente superior a 50°C disminuye las prestaciones. Esta recomendada la instalación de una bobina con mayores prestaciones.

NOTE: In DC temperature higher than 50°C the performances might decrease. The installation with coil highward-facing is well recommended.

Consultar disponibilidad en otros materiales.

Los datos técnicos y gráficos no son vinculantes. - Drawing and technical data are not binding.

Electroválvulas INOX AISI 316L serie COMPACT con accionamiento directo 2/2 vías NC
 Solenoid valve INOX AISI 316L COMPACT series 2/2 ways direct acting NC

SVXC2C

	REFERENCIA	G	L mm	L1 mm	H mm	P1 mm	P2 mm	A mm	B mm	YS mm
	SVXC2C15G18	G1/8"	33	20	62,5	20	42,5	26	45	10
	SVXC2C15G14	G1/4"	35	20	62,5	20	42,5	26	45	10
	SVXC2C30G18	G1/8"	33	20	62,5	20	42,5	26	45	10
	SVXC2C30G14	G1/4"	35	20	62,5	20	42,5	26	45	10

AISI 316

Electroválvula INOX AISI 316L serie STANDARD con accionamiento directo 2/2 vías NC
 Solenoid valve INOX AISI 316L STANDARD series 2/2 ways & direct acting NC

SVX2C

	REFERENCIA	G	L mm	L1 mm	H mm	P1 mm	P2 mm	A mm	B mm	YS mm
	SVX2C15G18	G1/8"	41	25	75	25	50	36	57	15,4
	SVX2C30G18	G1/8"	41	25	75	25	50	36	57	15,4
	SVX2C25G14	G1/4"	41	25	75	25	50	36	57	15,4
	SVX2C40G14	G1/4"	41	25	75	25	50	36	57	15,4
	SVX2C50G38	G3/8"	46,5	25	75	25	50	36	57	15,4
	SVX2C64G38	G3/8"	46,5	25	75	25	50	36	57	15,4
	SVX2C64G12	G1/2"	50,5	25	75	25	50	36	57	15,4
	SVX2C100G12	G1/2"	60	30	90	30	60	36	57	15,4

AISI 316

Electroválvula INOX AISI 316L serie STANDARD con accionamiento directo 3/2 vías NC
 Solenoid valve INOX AISI 316L STANDARD series 3/2 ways direct acting NC

SVX3C

	REFERENCIA	G	L mm	L1 mm	H mm	P1 mm	P2 mm	A mm	B mm	YS mm
	SVX3C15G18	G1/8"	41	25	84	25	59	36	57	15,4
	SVX3C25G14	G1/4"	41	25	84	25	59	36	57	15,4
	SVX3C40G14	G1/4"	41	25	84	25	59	36	57	15,4

AISI 316

Bajo pedido se pueden suministrar desengrasadas para utilizar con oxígeno y con recubrimiento de teflón en las partes en contacto con fluidos.

On demand can be supplied degreased for use with oxygen and teflon coated parts in contact with fluid.



ACCESORIOS · *Accessories*

SILENCIADORES · *Silencers*

DEPÓSITOS · *Tanks*

ELEMENTOS DE ESTANQUEIDAD PARA ROSCAS · *Sealing for threaded elements*

ABRAZADERAS · *Clamps*

RACORES FIJOS Y GIRATORIOS PARA MANGUERA · *Joints for spiral hoses*

ACCESORIOS PARA TUBOS · *Accessories for tubes*

MANÓMETROS Y VACUÓMETROS · *Pressure gauges*

PISTOLAS SOPLADO, INFLADORES NEUMÁTICOS Y KIT DE SOPLADO

Air guns, tyre-inflating guns and air gun kit assembled with fittings

Designación de la referencia - Model designation

SILEN	ALT	1
Código Code	ALT: Alto BAJ: Bajo NY: Nylon SIL-ESC: De escape P: Alto plástico	Rosca Thread size
		Métrica Metric Thread
		M5 M5
		Cilíndrica BSPP BSPP thread
		1 G1/8"
		2 G1/4"
		3 G3/8"
		4 G1/2"
		6 G3/4"
		8 G1"

Datos Técnicos	
Aplicaciones	Neumática
Materiales utilizados	Bronce sinterizado esférico 89% Cu y 11% Sn con base acero cobrizado o latón (ver tabla) Plástico: código SILENNY y SILENP Polietileno: código SILENP Nylon: código SILENNY Acero INOX AISI 316: código SILENBAJ-X
Rosca	Gas cilíndrica BSPP
	Métrica M5
Producto conforme a la directiva 2002/95/EC RoHS	

Technical specifications	
Applications	Pneumatics
Materials used	Sinterized spheric bronze powder 89% Cu & 11% Sn on the base copper plated brass or integral bronze (see technical tables) Plastic: code SILENNY and SILENP Polyethylene: code SILENP Nylon: code SILENNY Stainless steel AISI 316 SILENBAJ-X
Threads	Cylindrical gas BSPP
	Metric M5
Products in conformity with the directive 2002/95/EC RoHS	

Silenciador Alto. Silenciador de bronce sinterizado con base en acero cobrizado
 Hexagonal coppered base silencer. Cone-shaped silencer of sinterized spherical bronze with hexagonal coppered steel base

SILENALT	REFERENCIA	T	P	I	F	L	H (Hex)	Peso Weight(g)
	SILENALT M5	M5	5,5	3,5	4	17	7	2
	SILENALT1	G1/8"	10,5	4,5	3,8	21	12	6
	SILENALT2	G1/4"	12,5	6	4,5	27	15	12,5
	SILENALT3	G3/8"	17	7	5,4	35	19	23
	SILENALT4	G1/2"	20,5	8	6	40,5	23	39
	SILENALT6	G3/4"	26,5	9	7,5	51,5	30	78,5
	SILENALT8	G1"	33	11	9	66	36	149,5

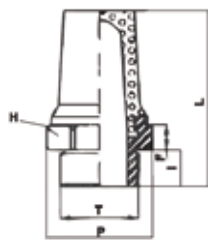

Nivel de ruido en db a 4 bar y a 6 bar • Level of noise in dB at 4 Bar & 6 Bar

BAR	1/8"	1/4"	3/8"	1/2"	3/4"	1"
4 Bar	76	75	81	84	92	92
6 Bar	79	78	82	85	94	95

Silenciador de cabeza hexagonal. Silenciador de bronce sinterizado con cabeza hexagonal y base circular en acero cobrizado
 Hexagonal head silencer. Hexagonal head cone-shaped silencer of sinterized spherical bronze with circular coppered steel base

SILENALTH	REFERENCIA	T	P	I	L1	L2	H (Hex)	Peso Weight(g)
	SILENALTH1	G1/8"	11,5	4,5	21,5	17	8	6,5
	SILENALTH2	G1/4"	15	6	28	22	10	12,5
	SILENALTH3	G3/8"	19	7	36	29	13	23,5
	SILENALTH4	G1/2"	23	8	43	35	15	39
	SILENALTH6	G3/4"	30	9	56	47	19	77,5
	SILENALTH8	G1"	37	11	69	58	24	139

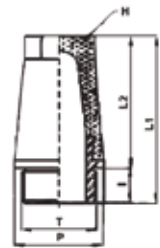

Nivel de ruido en db a 4 bar y a 6 bar • Level of noise in dB at 4 Bar & 6 Bar

BAR	1/8"	1/4"	3/8"	1/2"	3/4"	1"
4 Bar	77	76	82	84	91	92
6 Bar	80	79	83	85	95	95

Silenciador bajo malla INOX cuerpo latón. Silenciador bajo con malla Inox en latón
 Stainless steel wired silencer on hexagonal brass base

SILENBAJ	REFERENCIA	T	I	L	H (Hex)	Peso Weight(g)
	SILENBAJ M5	M5	4	8	8	1,5
	SILENBAJ1	G1/8"	6	15	13	6
	SILENBAJ2	G1/4"	7	18	16	10,5
	SILENBAJ3	G3/8"	8	20	19	16,5
	SILENBAJ4	G1/2"	10	22	24	24,5
	SILENBAJ6	G3/4"	10	26	30	37
	SILENBAJ8	G1"	12	28	36	56,5

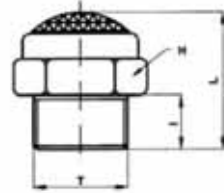

Nivel de ruido en db a 4 bar y a 6 bar • Level of noise in dB at 4 Bar & 6 Bar

BAR	1/8"	1/4"	3/8"	1/2"	3/4"	1"
4 Bar	70	69	85	85	86	88
6 Bar	74	72	88	90	90	92

Silenciador con regulador de escape en latón. Silenciador de bronce sinterizado con regulador de escape en latón
Brass silencer for flow control. Silencer of sinterized bronze pastille for flow control

IMOSIL-ESC	REFERENCIA	ROSCA H ØD	DN (mm)	L (mm)	H (mm)	H (hex)	Peso Weight (g)
	IMOSIL-ESC01	G1/8"	26	28	6	13	16
	IMOSIL-ESC02	G1/4"	30	32	8	15	23
	IMOSIL-ESC03	G3/8"	35	38	10	22	48
	IMOSIL-ESC04	G1/2"	36	39	10	22	59

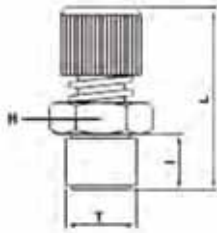

Nivel de ruido en db a 4 bar y a 6 bar • Level of noise in dB at 4 Bar & 6 Bar

BAR	1/8"	1/4"	3/8"	1/2"
4 Bar	69	70	82	84
6 Bar	70	67	77	80

Silenciador de nylon dinámico • Dynamic plastic silencer with balls

SILENNY	REFERENCIA	T	P	I	L1	L2	Peso Weight (g)
	SILENNY1	G1/8"	15	6	32,5	26,5	4
	SILENNY2	G1/4"	19,5	8	43	35	8
	SILENNY3	G3/8"	24,5	11	58	47	18
	SILENNY4	G1/2"	24,5	11	58	47	19
	SILENNY6	G3/4"	48	18	115	97	115
	SILENNY8	G1"	48	18	115	97	115

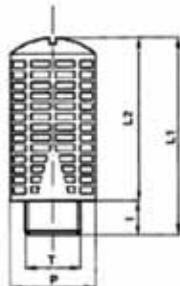

Nivel de ruido en db a 4 bar y a 6 bar • Level of noise in dB at 4 Bar & 6 Bar

BAR	1/8"	1/4"	3/8"	1/2"	3/4"	1"
4 Bar	84	81	83	83	85	85
6 Bar	87	84	90	90	91	90

Silenciador alto de polietileno sinterizado • Noise silencer to in polyethylene

SILENP	REFERENCIA	T	P	I	L1	L2	Peso Weight(g)
	SILENPM5	M5	7	4	24	20	2,8
	SILENP1	G1/8"	13	6	28	22	3,7
	SILENP2	G1/4"	17	7	34	27	10
	SILENP3	G3/8"	25	10	64	54	13,5
	SILENP4	G1/2"	25	10	65	55	37
	SILENP6	G3/4"	37	15	137	122	47
	SILENP8	G1"	48	19	152	133	90

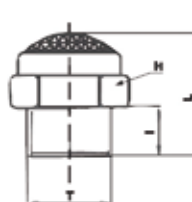

Silenciador de nylon e hilo de acero inoxidable • Nylon & inox wire silencer

 SILENBAJNX	REFERENCIA	T	I	L	H (Hex)	Peso Weight(g)	
	SILENBAJN1X	G1/8"	6	15	13	1,5	
	SILENBAJN2X	G1/4"	7	18	16	2,8	
	SILENBAJN3X	G3/8"	8	20	19	4,5	
	SILENBAJN4X	G1/2"	10	22	24	7,5	

Nivel de ruido en db a 4 bar y a 6 bar • Level of noise in dB at 4 Bar & 6 Bar

BAR	1/8"	1/4"	3/8"	1/2"
4 Bar	70	69	85	85
6 Bar	74	72	88	90

Silenciador bajo hexagonal INOX AISI 316 • Compact hexagonal silencer INOX AISI 316

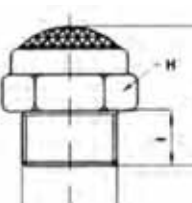
 SILENBAJX	REFERENCIA	T	I	L	H (Hex)	Peso Weight(g)	
	SILENBAJ1X	G1/8"	6	15	13	5	
	SILENBAJ2X	G1/4"	7	18	16	10	
	SILENBAJ3X	G3/8"	8	20	19	15	
	SILENBAJ4X	G1/2"	10	22	24	25	
	SILENBAJ6X	G3/4"	10	26	30	40	
	SILENBAJ8X	G1"	12	28	36	95	

Nivel de ruido en db a 4 bar y a 6 bar • Level of noise in dB at 4 Bar & 6 Bar

BAR	1/8"	1/4"	3/8"	1/2"	3/4"	1"
4 Bar	70	69	85	85	86	88
6 Bar	74	72	88	90	90	92

NUEVO

Designación de la referencia - Model designation

SB	08	20	SBST
Código Code	Diámetro Diameter	Altura Height	Tipo de sorpote Type fixing



Depósito de aire comprimido en acero Inox AISI 304 para uso alimentario.
Certificado de soldadura Bureau Veritas WPAR n° 2374, n° 2375, n° 2376 según norma EN 15614-1/1418/287-1

Tank for compressed air in stainless steel AISI 304 for food.
Qualification welding bureau veritas WPAR No. 2374, No. 2375, No. 2376 according to standard EN 15614-1/1418/287-1

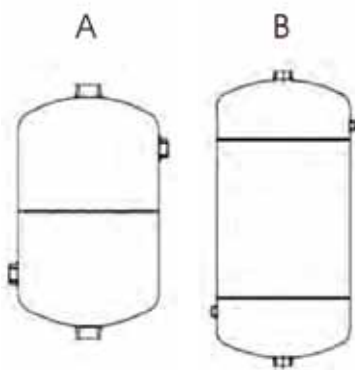

A: Depósito con dos tapas (2 piezas) para 100 y 130 de diámetro
B: Depósito con dos tapas y cuerpo central soldado longitudinalmente (3 piezas)

A: tank two caps, a fishing trip and a cropped with the TIG welding (2 pieces) for 100 and 130 diameter.
B: tank caps to two trips with cloak central to TIG welded longitudinal (3 pieces).

STV



STL



STC



Soporte ya montado
Bracket provided already mounted

Soporte proporcionado por separado
Bracket provided separately

Soporte ya montado
Bracket provided already mounted

Bajo pedido se fabrican depósitos especiales:

Según diseño del Cliente
PN 20
En AISI 316
Con un pulido efecto espejo
Decapado para sector farmacéutico / medicinal
Producto conforme a la directiva 2002/95/EC
Producto conforme a la directiva 1907/2006

Available on demand:

On customer's drawing
PN 20
In AISI 316
With polishing mirror
With pickling for the medical / pharmaceutical sector
Products in conformity with the directive 2002/95/EC
Products in conformity with the directive 1907/2006

Consultar nuestro apartado de válvulas de esfera y racores roscados de acero INOX. AISI 303-316, para aplicaciones con estos depósitos.

Los datos técnicos y gráficos no son vinculantes. - Drawing and technical date are not binding.

NUEVO

Depósito en acero INOX AISI 304 • Tank stainless steel AISI 304

SB

REFERENCIA	Ø	H	Vol Lt.	C alt.cal.	M1 man.cal. (*)	M2 man.mant.	Peso Weight(g)	
SB1019	100	190	1,5	50	2x1/2"	—	850	
SB1310	130	100	1	50	2x1/2"	—	650	
SB1313	130	130	1,5	65	2x1/2"	—	800	
SB1317	130	175	2	87,5	2x1/2"	1x1/4"	1000	
SB1535	150	350	5,5	45	2x1/2"	2x1/4"	2200	(**)
SB1622	160	220	4	45	2x1/2"	2x1/4"	1600	(**)
SB1756	170	560	10	50	2x1/2"	2x1/4"	3800	(**)
SB1933	190	330	8,5	60	2x1/2"	2x1/4"	2700	(**)
SB1942	190	420	11	60	2x1/2"	2x1/4"	3300	(**)
SB2052	200	520	15	75	2x1/2"	2x1/4"	4200	(**)
SB2254	220	540	19	60	2x1/2"	2x1/4"	4850	(**)
SB2440	245	400	17	70	2x1/2"	2x1/4"	4150	(**)
SB2454	245	540	24	70	2x1/2"	2x1/4"	5450	(**)
SB3045	300	450	29	90	2x1"	3x3/4"	5750	(***)
SB3076	300	760	50	90	2x1"	3x3/4"	9200	(***)
SB3169	315	690	50	90	2x1"	3x3/4" + 1x1/4"	12000	(****)
SB3360	330	590	46	110	2x1"	3x3/4" + 1x1/4"	8100	(****)
SB33118	330	1180	95	110	2x1"	3x3/4" + 1x1/4"	15300	(****)
SB3674	360	740	70	115	2x1"	3x3/4" + 1x1/4"	10300	(****)
SB40125	400	1250	150	125	2x1"	3x3/4" + 1x1/4"	26400	(****)
SB50105	500	1050	190	120	2x1"	3x3/4" + 1x1/4"	28600	(****)
SB50150	500	1500	280	120	2x1"	3x3/4" + 1x1/4"	39650	(****)
SB60180	600	1800	480	125	2x1"	3x3/4" + 1x1/4"	57100	(****)
SB70200	700	2000	730	140	2x1"	3x3/4" + 1x1/4"	74200	(****)

(*) Un manguito soldado al centro de cada tapa

(**) Mangos soldados centralmente a lo largo del manto, uno arriba + uno abajo

(***) 2 agujeros en cada uno, a 50 mm de la soldadura - un agujero por debajo, ubicado en el centro a lo largo del manto

(****) 2 agujeros anteriores (1 x 3/4 "x 1/4 + 1"), cada uno a 50 mm de la soldadura - Dos agujeros abajo, cada uno a 50 mm de la soldadura

Depósito en acero INOX AISI 304 con patas en L • Stainless steelS

SB-STL

REFERENCIA	Ø	H	Vol Lt.	ST IF int. agujero (*)	ST IS int. soporte	ST Hs alt. soporte	Peso Weight(g)
SB1019-STL	100	190	1,5	40	**	120	850
SB1310-STL	130	100	1	40	**	120	650
SB1313-STL	130	130	1,5	40	**	120	800
SB1317-STL	130	175	2	40	**	120	1000
SB1535-STL	150	350	5,5	40	**	175	2200
SB1622-STL	160	220	4	40	**	175	1600
SB1756-STL	170	560	12	40	**	175	3800
SB1933-STL	190	330	8,5	40	**	175	2700
SB1942-STL	190	420	11	40	**	175	3300
SB2052-STL	200	520	15	40	**	175	4200
SB2254-STL	220	540	19	40	**	175	4850
SB2440-STL	245	400	17	40	**	175	4150
SB2454-STL	245	540	24	40	**	175	5450

(*) Los soportes se suministran con 2 conexiones (cónica reducción macho 1/4 hembra 1/4)

(**) Altura del tanque + 2x15mm + longitud de la manga

* Soporte para montar

NUEVO

Depósito en acero INOX AISI 304 con patas en cuña • Stainless steel AISI 304 with cradle brackets tank

SB-STC

REFERENCIA	∅	H	Vol Lt.	STB IF int. agujero (*)	STB IS int. soporte	STB Hs alt. soporte	Peso Weight(g)
SB1310-STC	130	100	1	60	60	35	650
SB1313-STC	130	130	1,5	60	60	35	800
SB1317-STC	130	175	2	60	60	35	1000
SB1535-STC	150	350	5,5	60	80	35	2200
SB1622-STC	160	220	4	60	120	40	1600
SB1756-STC	170	560	12	60	220	40	3800
SB1933-STC	190	330	8,5	80	180	45	2700
SB1942-STC	190	420	11	80	200	45	3300
SB2052-STC	200	520	15	80	225	45	4200
SB2254-STC	220	540	19	80	225	45	4850
SB2440-STC	245	400	17	80	220	50	4150
SB2454-STC	245	540	24	80	225	50	5450
SB3045-STC	300	450	29	200	210	70	5750
SB3076-STC	300	760	50	200	475	70	9200
SB3169-STC	315	690	50	200	225	70	12000
SB3359-STC	330	590	46	200	330	70	8100
SB33118-STC	330	1180	95	200	800	70	15300
SB3674-STC	360	740	70	230	450	70	10300
SB40125-STC	400	1250	150	300	800	70	26400
SB50105-STC	500	1050	190	300	800	70	28600
SB50150-STC	500	1500	280	300	1100	70	39650
SB60180-STC	600	1800	480	300	1350	70	57100
SB70200-STC	700	2000	730	300	1500	70	74200

(*) Todos los orificios de los soportes están ranurados

NUEVO

Depósito en acero INOX AISI 304 vertical • Stainless steel AISI 304 tank vertical

SB-STV

REFERENCIA	∅	H	Vol Lt.	STV (*) ∅ D soporte	STV (*) Hs h. soporte	Peso Weight(g)
SB1535-STV	150	350	5,5	90	90	2200
SB1622-STV	160	220	4	110	90	1600
SB1756-STV	170	560	12	110	90	3800
SB1933-STV	190	330	8,5	120	90	2700
SB1942-STV	190	420	11	120	90	3300
SB2052-STV	200	520	15	120	120	4200
SB2254-STV	220	540	19	140	120	4850
SB2440-STV	245	400	17	150	130	4150
SB2454-STV	245	540	24	150	130	5450
SB3045-STV	300	450	29	220	130	5750
SB3076-STV	300	760	50	220	130	9200
SB3169-STV	315	690	50	220	130	12000
SB3359-STV	330	590	46	230	150	8100
SB33118-STV	330	1180	95	230	150	15300
SB3674-STV	360	740	70	250	170	10300
SB40125-STV	400	1250	150	360	200	26400
SB50105-STV	500	1050	190	450	200	28600
SB50150-STV	500	1500	280	450	200	39650
SB60180-STV	600	1800	480	560	200	57100
SB70200-STV	700	2000	730	660	200	74200

(*) Los soportes tienen dos aberturas arqueadas opuestas entre sí.

ELEMENTOS DE ESTANQUEIDAD - SEALING FOR THREADED ELEMENTS

Adhesivos Anaeróbicos

Selladores de Roscas

Fijan y sellan conexiones roscadas frente a presión de gas, aire, agua, aceites, hidrocarburos y muchos productos químicos. Reemplazan el cáñamo, las cintas de PTFE y están disponibles en varios grados de resistencia al desmontaje y a productos químicos. Certificados de acuerdo a varias Normas Internacionales, por ejemplo DVGW, NSF, WRAS, KTW, BAM.

Fijadores de Roscas

Fijan tuercas, tornillos, espárragos y cualquier elemento roscado. El adhesivo previene el aflojamiento causado por vibración y por choques mecánicos y térmicos; también inhiben la corrosión por frotamiento y evitan el gripaje y la oxidación.

Formadores de Juntas

Sellan superficies metálicas mecanizadas planas y juntas de bridas en bombas, cajas de cambio y cajas de diferencial. Reemplazan las juntas tradicionales y permiten el contacto entre las partes de metal, formando un sellado que evita el agarrotamiento y la relajación. Forman una junta elástica y/o flexible que es resistente a vibración, calor, aceite y otros fluidos industriales. Las piezas pueden ser desmontadas con herramientas normales.

Retenedores

Fijan y ajustan pasadores, rodamientos, camisas, bulones, chavetas, engranajes y otros componentes cilíndricos. Son ideales para aumentar la resistencia de piezas montadas a presión o retención de piezas montadas con holgura, permiten mayores tolerancias de mecanizado, reduciendo los costes de fabricación y previniendo la corrosión por frotamiento, distorsiones y aflojamientos por vibración. Tienen una resistencia química excelente y sellan la mayoría de los fluidos.

Adhesivos Instantáneos

Los adhesivos de cianoacrilato están diseñados para un pegado estructural e instantáneo de goma, metales, cerámica, cuero, madera y una amplia variedad de plásticos. Se recomienda que las superficies a unir se ajusten íntimamente; los mejores resultados se obtienen con holguras inferiores a 0,1 mm y hasta 0,2 mm para grados especiales. El rango de temperatura funcional va desde -50 a 80°C, y en las nuevas formulaciones resistentes a alta temperatura se alcanzan los +200°C. Para superficies muy porosas y aplicaciones verticales existe una formulación en gel.

Adhesivos Bicomponentes

Proporcionan uniones de alta resistencia y juntas estructurales. Son adecuados para la adhesión de metales, cerámica, madera y algunos plásticos y se suministran en un práctico cartucho doble dispensador. El curado se produce por la reacción química de la mezcla de los dos componentes (resina y endurecedor). El tiempo de fijación es desde 5- 10 minutos hasta varias horas. La aplicación de calor acelera el proceso de curado. La resistencia a temperatura es desde -30 °C hasta +80 °C, pero también disponemos de grados especiales que llegan a soportar +150°C.

Activadores y preparadores de superficie

Los activadores son productos diseñados específicamente para incrementar la velocidad de curado de los diferentes tipos de adhesivos. Condiciones típicas de uso son: baja temperatura, grandes holguras, metales poco reactivos y superficies pasivas. Los limpiadores aseguran la ausencia de residuos incompatibles con el adhesivo. La aplicación del activador se hará en una o en ambas superficies dependiendo de la necesidad; si contiene disolventes hay que esperar unos segundos hasta su evaporación. La superficie tratada permanece activa durante largo tiempo, pero el montaje debe realizarse en pocos segundos desde el momento de la aplicación del producto.



SELLADORES DE ROSCAS

Sellador líquido anaeróbico para racores neumáticos e hidráulicos hasta 3/4" y media resistencia mecánica

SELLOX	Tiempo de manipulación	Tiempo de endurecimiento	Diám.máx. rosca/tolerancia máx. unión	Para de apriete M10	Temperatura de trabajo	Cantidad
	10-20 minutos	1-3 horas	3/4"-0,15	12-16 (n.m)	de -55°C a 150°C	10, 50 y 250 ml

Sellador de roscas alta temperatura. Homologado para gas (DIN-DVGW) – película elástica

LOX-1536BS	Tiempo de manipulación	Tiempo de endurecimiento	Diám.máx. rosca/tolerancia máx. unión	Para de apriete M10	Temperatura de trabajo	Cantidad
	15-30 minutos	1-3 horas	2"-0,3	8-14 (n.m)	de -55°C a 180°C	75 y 250 ml

Sellador con PTFE de alta viscosidad. Homologado para gas (AGA; DIN-DVGW) y agua potable (WRAS) - película elástica

LOX-1810	Tiempo de manipulación	Tiempo de endurecimiento	Diám.máx. rosca/tolerancia máx. unión	Para de apriete M10	Temperatura de trabajo	Cantidad
	20-40 minutos	1-3 horas	2"-0,3	6-11 (n.m)	de -55°C a 150°C	50 y 75 ml

Sellador uso general, media viscosidad

LOX-5514	Tiempo de manipulación	Tiempo de endurecimiento	Diám.máx. rosca/tolerancia máx. unión	Para de apriete M10	Temperatura de trabajo	Cantidad
	10-20 minutos	1-3 horas	2"-0,3	12-18 (n.m)	de -55°C a 150°C	50 ml

Sellador de alta viscosidad homologado para gas (DIN-DVGW), GLP alta presión (AGA), oxígeno gaseoso hasta 10bar y 60°C (BAM) y agua potable (WRC-WRAS). Contacto con alimentos (NSF-P1).

LOX-5811	Tiempo de manipulación	Tiempo de endurecimiento	Diám.máx. rosca/tolerancia máx. unión	Para de apriete M10	Temperatura de trabajo	Cantidad
	15-30 minutos	1-2 horas	2"-0,3	18-24 (n.m)	de -55°C a 150°C	50 ml



FIJADORES DE ROSCAS

Fijación de baja resistencia y anti-vibración. Uso general

LOX-2418	Tiempo de manipulación	Tiempo de endurecimiento	Diám.máx. rosca/tolerancia máx.unión	Para de apriete M10	Temperatura de trabajo	Cantidad
	15-30 minutos	1-3 horas	M24-0,2	5-8 (n.m)	de -55°C a 150°C	10 y 50 ml

Fijatuercas de uso general

LOX-5403	Tiempo de manipulación	Tiempo de endurecimiento	Diám.máx. rosca/tolerancia máx.unión	Para de apriete M10	Temperatura de trabajo	Cantidad
	10-20 minutos	1-3 horas	M24-0,2	14-20 (n.m)	de -55°C a 150°C	50 ml

Alta temperatura, adecuado para su uso en piezas ligeramente aceitadas.
 Aprobado para gas(DIN-DV6W y GAZ DE FRANCE) y agua potable (TZW-DVGW).

LOX-5503	Tiempo de manipulación	Tiempo de endurecimiento	Diám.máx. rosca/tolerancia máx.unión	Para de apriete M10	Temperatura de trabajo	Cantidad
	10-20 minutos	1-3 horas	M36-0,25	18-23 (n.m)	de -55°C a 200°C	10 ml

Alta resistencia. Uso general

LOX-8354	Tiempo de manipulación	Tiempo de endurecimiento	Diám.máx. rosca/tolerancia máx.unión	Para de apriete M10	Temperatura de trabajo	Cantidad
	10-20 minutos	1-3 horas	M20-0,15	25-35 (n.m)	de -55°C a 150°C	10 ml



FORMADORES DE JUNTAS

Producto para juntas de uso general

LOX-5814	Tiempo de manipulación	Tiempo de endurecimiento	Tolerancia máx. unión	Temperatura de trabajo	Cantidad
	15-30 minutos	3-6 horas	0,5	de -55°C a 150°C	75 ml

Alta viscosidad para juntas rígidas con grandes tolerancias de montaje. Alta temperatura

LOX-5910	Tiempo de manipulación	Tiempo de endurecimiento	Tolerancia máx. unión	Temperatura de trabajo	Cantidad
	15-30 minutos	3-6 horas	0,5	de -55°C a 200°C	75 y 100 ml



RETENEDORES

Retención de rodamientos. Uso general

LOX-5311	Tiempo de manipulación	Tiempo de endurecimiento	Diám. máx. rosca/tolerancia máx. unión	Para de apriete M10	Temperatura de trabajo	Cantidad
	10-20 minutos	1-3 horas	M20-0,12	11-20 (n.m)	de -55°C a 150°C	50 ml

Para acoplamiento de precisión, alta resistencia, curado rápido

LOX-8221	Tiempo de manipulación	Tiempo de endurecimiento	Diám. máx. rosca/tolerancia máx. unión	Para de apriete M10	Temperatura de trabajo	Cantidad
	5-10 minutos	1-3 horas	M12-0,1	24-35 (n.m)	de -55°C a 150°C	50 ml

Retenedor de curado rápido, permite mayores tolerancias de mecanización. Homologado para gas (Gaz de France)

LOX-8521	Tiempo de manipulación	Tiempo de endurecimiento	Diám. máx. rosca/tolerancia máx. unión	Para de apriete M10	Temperatura de trabajo	Cantidad
	2-5 minutos	1-3 horas	M36-0,2-1 1/2"	30-40 (n.m)	de -55°C a 150°C	10 y 50 ml



ADHESIVOS INSTANTÁNEOS

Muy rápido, fluido, buenos resultados en EPDM, gomaespuma, gomas difíciles y plástico

IS32	Composición química	Velocidad de curado	Cantidad
	Etilo	muy alta	20 ml

Uso general para el pegado de plásticos, metales, cuero, madera y goma

IS43	Composición química	Velocidad de curado	Cantidad
	Etilo	muy alta	20 ml

Gel, relleno de grandes holguras, para pegados verticales y superficies muy porosas

IS47	Composición química	Velocidad de curado	Cantidad
	Etilo	baja	20 ml

Uso general, inodoro y sin empañamiento

IS63	Composición química	Velocidad de curado	Cantidad
	Alcoxi	muy baja	20 ml



VARIOS

Jeringa doble Epoxi 2K

LOX-3142	Cantidad
	20 ml

Silicona para aplicaciones de alta temperatura

LOX-5930	Tiempo de formación de piel	Tiempo de curado cordón ø2 mm	Dureza shore	Temperatura de trabajo	Cantidad	Color
	15-30 minutos	24 horas	32±5	de -60°C a 300°C	75 ml	rojo

Activador líquido libre de solventes para usar con los adhesivos acrílicos 30-55, 33-00, 33-55. También se utiliza con los adhesivos anaeróbicos

LOX-AT20	Cantidad
	20 ml

Cinta de PTFE para sellado de roscas para aplicaciones con aire comprimido y agua

IMOTF	Uso	Longitud	Espesor
	1/2"	12 metros	0,075 mm

Cinta de PTFE para uso profesional

IMOTFP	Uso	Longitud	Espesor
	3/4"	50 metros	0,1 mm

ARANDELAS - WASHERS

Arandela dentada en nylon • Nylon notched washer

2610	REFERENCIA	Rosca thread	A	B	C	Peso Weight(g)
	2610TRM5	M5	8	5,2	1,3	2
	2610TR18	G1/8"	14	10	2	26
	2610TR14	G1/4"	18	13,5	2	42
	2610TR38	G3/8"	21	16,8	2	28
	2610TR12	G1/2"	26	21,1	2	38

Arandela en PVC • PVC washer

2612	REFERENCIA	Rosca thread	D4	d4	H	Peso Weight(g)
	2612TR18	G1/8"	14	10	1,5	18
	2612TR14	G1/4"	17,5	13,5	1,5	18
	2612TR38	G3/8"	21	16,7	1,5	18
	2612TR12	G1/2"	26	21,3	1,5	18

Designación de la referencia - Model designation



Tornillo sin fin	
Código	Materiales material
AB	INOX AISI 430
ABX	INOX AISI 304
2 orejas	
Código	Materiales material
AB02	Acero St34
AB02X	INOX AISI 304

Materiales - Materials		
AB	Cinta y soporte en acero INOX AISI 430, tornillo de acero cincado gris plata, exento de cromo (directiva EU RoHS)	Housing & band stainless steel 430, screw zinc plated steel with white trivalent zinc plating, RoHS compliant coating
ABX	Cinta, soporte y tornillo en acero INOX AISI 304	Band, housing & screw stainless steel 304
ABO2	Acero St34, tratamiento cincado Cr3	Steel St34 zinc plated Cr3
ABO2X	Acero inoxidable AISI 304	Stainless steel AISI 304

Aplicaciones - Applications	
Automoción, motocicletas, motores	Vehicles, motorcycles,automotives
Maquinaria agrícola	Agricultural machines
Herramienta	Hardware
Termohidráulica y Fontanería	Plumbing sanitary & termohidraulic
Embarcaciones	Shipyards
Motores marinos	Marine engines
Industria petroquímica	Petrochemical industry
Industria alimentaria	Food industry
Industria química	Chemical industry

Los datos técnicos y gráficos no son vinculantes. - Drawing and technical date are not binding.

Abrazadera según DIN 3017, con banda de 9mm, cinta y soporte en acero INOX AISI 430 y tornillo en acero cincado
Worm drive hose clamp to DIN 3017, band width 9mm, housing in INOX AISI 430 and screw in zinc coated steel

AB	REFERENCIA	Ø d (mm) min - max	
	AB-8-16	12-16	50
	AB-12-22	12-22	50
	AB-16-27	16-27	50
	AB-20-32	20-32	50
	AB-25-40	25-40	50

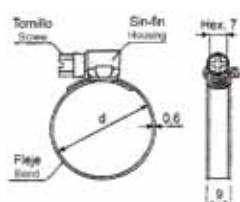

Abrazadera según DIN 3017, con banda de 9mm, cinta, soporte y tornillo en acero INOX AISI 304
Worm drive hose clamp to DIN 3017, band width 9mm, housing & screw in INOX AISI 304

ABX	REFERENCIA	Ø d (mm) min - max	
	ABX-8-16	8-16	10
	ABX-12-22	12-22	10
	ABX-16-27	16-27	10
	ABX-20-32	20-32	10
	ABX-25-40	25-40	10

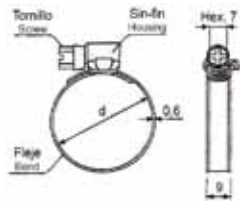

Abrazadera de 2 orejas en acero St34 acabado cincado Cr3 • Worm drive hose in zinc plated steel

ABO2	REFERENCIA	Ø A (mm) min - max	A (mm)	B (mm)	C (mm)	D (mm)	E (mm)
	ABO2-10-12	10 - 12	12,3	5,5	6,5	18	0,9
	ABO2-11-13	11 - 13	13,3	5,8	6,5	19	0,9
	ABO2-13-15	13 - 15	15,3	6,3	7	21,5	1
	ABO2-14-17	14 - 17	17,5	6,6	7	24	1,2
	ABO2-15-18	15 - 18	18,5	7	7,5	25	1,2
	ABO2-17-20	17 - 20	20,5	7,6	7,5	27	1,2
	ABO2-18-21	18 - 21	21,5	7,9	8	28	1,2
	ABO2-20-23	20 - 23	23,5	8,5	8	31	1,3

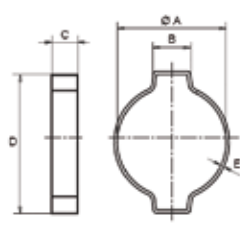

Abrazadera de 2 orejas en acero inoxidable AISI 304 • Worm drive hose in inox AISI 304

ABO2X	REFERENCIA	Ø A (mm) min - max	A (mm)	B (mm)	C (mm)	D (mm)	E (mm)
	ABO2-10-12	10 - 12	12,3	5,5	6,5	18	0,9
	ABO2-11-13	11 - 13	13,3	5,8	6,5	19	0,9
	ABO2-13-15	13 - 15	15,3	6,3	7	21,5	1
	ABO2-14-17	14 - 17	17,5	6,6	7	24	1,2
	ABO2-15-18	15 - 18	18,5	7	7,5	25	1,2
	ABO2-17-20	17 - 20	20,5	7,6	7,5	27	1,2
	ABO2-18-21	18 - 21	21,5	7,9	8	28	1,2
	ABO2-20-23	20 - 23	23,5	8,5	8	31	1,3

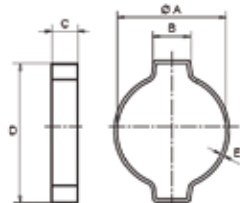

Racor fijo con rosca macho cónica BSPT para tubería poliamida • Straight male adaper BSPT thread + nut + spring

	REFERENCIA	ØD	T	I	L	H (Hex)
	IMORF614	6x4	R1/4"	11	113,5	14
	R.FIJO-1/4-6	8x6	R1/4"	11	120	14
	R.FIJO-3/8-6		R3/8"	11,5	120,5	17
	R.FIJO-1/4-8	10x8	R1/4"	11	128	14
	R.FIJO-3/8-8	12x10	R3/8"	11,5	128,5	17
	R.FIJO-3/8-10		R3/8"	11,5	136,5	17

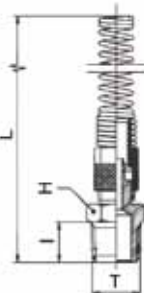

Racor giratorio con rosca macho cónica BSPT para tubería poliamida • Swivel straight male adaper BSPT thread + nut + spring

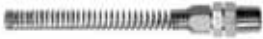
	REFERENCIA	ØD	T	I	L	H1 (Hex)	H2 (Hex)
	IMORG614	6x4	R1/4"	11	124	14	15
	R.GIR.-1/4-6	8x6	R1/4"	11	129	14	15
	R.GIR.-1/4-8	10x8	R1/4"	11	136	14	15
	R.GIR.-3/8-8		R3/8"	11,5	145	17	17
	R.GIR.-3/8-10	12x10	R3/8"	11,5	145	17	17

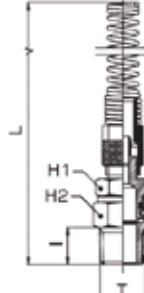

Racor fijo con rosca macho cónica BSPT para tubería poliuretano • Straight male adapter BSPP thread + nut + spring

	REFERENCIA	ØD	T
	IMORF614	6x4	R1/4"
	IMORF814	8x5,5	R1/4"
	IMORF1014	10x6,5	R1/4"

Racor giratorio con rosca macho cónica BSPT para tubería poliuretano • Swivel straight male adapter BSPP thread + nut + spring

	REFERENCIA	ØD	T
	IMORG614	6x4	R1/4"
	IMORG814	8x5,5	R1/4"
	IMORG1014	10x6,5	R1/4"
	IMORG1238	12x8	R3/8"

Cortatubo de plástico • Plastic tube cutter

	REFERENCIA	Medidas sizes	Peso Weight(g)
	COR.TUB-PL	12mm max	23
			



Cortatubo metálico • Metal hose cutter

	REFERENCIA	Medidas sizes	Cuchilla blade	Peso Weight(g)
	COR.TUB-12	12mm max	acero	99
	COR.TUB-25	25mm max	acero	289

Cuchilla de repuesto para cortatubo • Spare blade

	REFERENCIA	Peso Weight(g)
	CUCHILLA 12	1
	CUCHILLA 25	2

Soporte para tubos • Plastic pipe clip

	REFERENCIA	∅ tubo (mm)	A (mm)	B (mm)	C (mm)	D (mm)	∅ (mm)	E (mm)	N. Posiciones Position number	Peso Weight(g)
	FT-04	4	9	114	11,7	8	2,5	19	10	8
	FT-06	6	9	114	11,7	10	2,5	19	10	8
	FT-08	8	12	143	14,6	12	3,1	19	10	12
	FT-10	10	15	172	17,4	13,8	4,1	19	10	16
	FT-12	12	19	78	20,5	16,8	4,1	19	4	10
	FT-14	14	21	87	22,5	18,8	4,1	19	4	11
										

Soporte de bobinas desmontable • Bracket reel support

	REFERENCIA	∅ ext. (mm)	∅ int. (mm)	∅ eje paso (mm)	Altura	Peso Weight(g)
	SC-01	395	130	50	130	1400

Designación de la referencia - Model designation

MAN MANÓMETRO VAC	R	G	G	53	2,5																																
Código Code	Tipo de salida Connection type	Si se omite es: seco If omitted: unfilled	Material del racor Connection material	Ø Diámetro Ø diameter	Escala Range																																
	P: Posterior / back R: Radial / bottom	G: Baño de glicerina Glycerin filled	X: INOX Si se omite es: latón	<table border="1"> <tr><td>40</td><td>40 mm</td></tr> <tr><td>50</td><td>50 mm</td></tr> <tr><td>53</td><td>53 mm</td></tr> <tr><td>63</td><td>63 mm</td></tr> <tr><td>100</td><td>100 mm</td></tr> </table>	40	40 mm	50	50 mm	53	53 mm	63	63 mm	100	100 mm	<table border="1"> <tr><td>-1 - 0 Bar</td><td>-1</td></tr> <tr><td>0 - 2,5 Bar</td><td>2,5</td></tr> <tr><td>0 - 4 Bar</td><td>4</td></tr> <tr><td>0 - 6 Bar</td><td>6</td></tr> <tr><td>0 - 10 Bar</td><td>10</td></tr> <tr><td>0 - 12 Bar</td><td>12</td></tr> <tr><td>0 - 16 Bar</td><td>16</td></tr> <tr><td>0 - 25 Bar</td><td>25</td></tr> <tr><td>0 - 40 Bar</td><td>40</td></tr> <tr><td>0 - 60 Bar</td><td>60</td></tr> <tr><td>0 - 100 Bar</td><td>100</td></tr> </table>	-1 - 0 Bar	-1	0 - 2,5 Bar	2,5	0 - 4 Bar	4	0 - 6 Bar	6	0 - 10 Bar	10	0 - 12 Bar	12	0 - 16 Bar	16	0 - 25 Bar	25	0 - 40 Bar	40	0 - 60 Bar	60	0 - 100 Bar	100
40	40 mm																																				
50	50 mm																																				
53	53 mm																																				
63	63 mm																																				
100	100 mm																																				
-1 - 0 Bar	-1																																				
0 - 2,5 Bar	2,5																																				
0 - 4 Bar	4																																				
0 - 6 Bar	6																																				
0 - 10 Bar	10																																				
0 - 12 Bar	12																																				
0 - 16 Bar	16																																				
0 - 25 Bar	25																																				
0 - 40 Bar	40																																				
0 - 60 Bar	60																																				
0 - 100 Bar	100																																				

Presión de trabajo:
Max 3/4 del valor de la
escala

Working pressure: 3/4 max
scale value

Tabla de conversión de principales unidades de medida • Conversion table of the pressure units

Unidad- unit	bar	mbar	Pa	kPa	Mpa	kp/mm ²	kp/cm ²
1 bar	1	1000	100000	100	0,1	0,01019716	1,019716
1 mbar	0,001	1	100	0,1	0,001	0,0000101972	0,001019716
1 Pa	0,00001	0,01	1	0,001	0,000001	0,000000102	0,00001097
1 kPa	0,01	10	1000	1	0,001	0,0001019716	0,01019716
1 MPa	10	10000	1000000	1000	1	0,1019716	10,19716
1 kp/mm ²	98,0665	9806,5	9806650	9806,65	9,80665	1	100
1 kp/cm ²	0,980665	980,665	98066,5	98,0665	0,0980665	0,01	1
1 atm	1,01325	1013,25	101325	101,325	0,101325	0,01033227	1,033227
1 mmHg	0,001333224	1,333224	133,322	0,133324	0,000133322	0,00013951	0,00135951
1 mCA	0,0980665	98,0665	9806,05	9,80665	0,00980665	0,001	0,1
1 mmCA	0,00098067	0,0980665	9,80665	0,00980665	0,000009807	0,000001	0,0001
1 psi	0,06894757	68,94757	6894,757	6,894757	0,006894757	0,0070307	0,070307
1 H2O	0,00249089	2,49089	249,089	0,249089	0,000249089	0,0000254	0,00254
1 Hg	0,0338639	33,8639	3386,4	3,3864	0,0033864	0,000345312	0,0345312

MANÓMETRO SECO UNFILLED PRESSURE GAUGES

Aplicaciones - Applications

Para gases y líquidos que no sean altamente viscosos, no cristalicen y no sean agresivos a las aleaciones de cobre. Este instrumento deberá ser utilizado según las recomendaciones de la norma EN 837-1. Temperatura máxima de trabajo 60°C.

For gaseous and liquid media which are not highly viscous, do not crystallize and are not aggressive to copper alloys. these instruments must be used in accordance with the safety recommendations of EN 837-1. maximum working temperature 60°C.

Los datos técnicos y gráficos no son vinculantes. - Drawing and technical data are not binding.

Manómetro seco con caja metálica, tubo bourdon y racor en latón, conexión radial, con rosca macho cilíndrica BSPP
Unfilled pressure gauge for the industry with metallic case, spring & hub in brass, bottom connection, BSPT thread

MANR	REFERENCIA	Rosca conexión Connection thread	∅ Caja ∅ Case	Escala Range (bar)	Precisión Accuracy
	MANR53-2,5	G1/4"	53	0 - 2,5	Clase 2 / class 2
	MANR53-4			0 - 4	
	MANR53-6			0 - 6	
	MANR53-10			0 - 10	
	MANR53-16			0 - 16	
	MANR53-25			0 - 25	

Manómetro seco con caja metálica, tubo bourdon y racor en latón, conexión posterior, rosca macho cilíndrica BSPP
Unfilled pressure gauge for the industry with metallic case, spring & hub in brass, back connection, BSPP thread

MANP	REFERENCIA	Rosca conexión Connection thread	∅ Caja ∅ Case	Escala Range (bar)	Precisión Accuracy
	MANP53-2,5	G1/4"	53	0 - 2,5	Clase 2 / class 2
	MANP53-4			0 - 4	
	MANP53-6			0 - 6	
	MANP53-10			0 - 10	
	MANP53-16			0 - 16	
	MANR53-25			0 - 25	

Manómetro seco con caja metálica en acero, bisel cromado, racor y tubo bourdon en latón, conexión posterior rosca cilíndrica BSPP
Unfilled pressure gauge for the industry with metallic case, spring & hub in brass, back connection, BSPP thread

MANÓMETRO	REFERENCIA	Rosca conexión Connection thread	∅ Caja ∅ Case	Escala Range (bar)
	MANÓMETRO 1/8	G1/8"	40	0 - 10
	MANÓMETRO 1/4	G1/4"	50	0 - 16

VACUÓMETRO - VACUUM METER

Vacuómetro seco con caja de acero inoxidable AISI 304 y órganos internos de bronce y latón con rosca macho cilíndrica BSPP
Unfilled pressure gauge with INOX AISI 304 case, spring & hub in brass, connection BSPP thread

VAC	REFERENCIA	Tipo de rosca Connection	Rosca conexión Connection thread	∅ Caja ∅ Case	Escala Range (bar)	Precisión Accuracy
	VACR63-1	Radial	G1/4"	63	-1/0	Clase class 1,6
	VACP63-1	Posterior				

MANÓMETRO DE GLICERINA CON CAJA EN INOX AISI 304 FILLED PRESSURE GAUGES INOX AISI 304 CASE

Aplicaciones - Applications

Para gases y líquidos que no sean altamente viscosos, no cristalicen y no sean agresivos a las aleaciones de cobre.
Para mediciones en puntos sujetos a vibraciones y altas cargas de presión dinámicas.
Este instrumento deberá ser utilizado según las recomendaciones de la norma EN 837-1.
Temperatura máxima de trabajo 80°C.

For gaseous and liquid media which are not highly viscous, do not crystallize and are not aggressive to copper alloys.
Measuring points subject to vibrations and high dynamic pressure loads.
These instruments must be used in accordance with the safety recommendations of EN 837-1.
Maximum temperature 80°C.

Los datos técnicos y gráficos no son vinculantes. - Drawing and technical date are not binding.

Manómetro con glicerina con caja en INOX AISI 304, tubo bourdon y racor en latón, pantalla y aguja indicadora en aluminio, conexión radial, rosca cilíndrica BSPP
Filled pressure gauge with INOX AISI 304 case, spring & hub in brass, dial and pointer in aluminium, bottom connection, BSPP thread

MANRG	REFERENCIA	Rosca conexión Connection thread	Ø Caja Ø Case	Escala Range (bar)	Precisión Accuracy
	MANRG63-2,5	G1/4"	63	0 - 2,5	Clase / class 1,6
	MANRG63-4			0 - 4	
	MANRG63-6			0 - 6	
	MANRG63-10			0 - 10	
	MANRG63-16			0 - 16	
	MANRG63-25			0 - 25	
	MANRG63-40			0 - 40	
	MANRG63-60			0 - 60	
	MANRG63-100			0 - 100	
	MANRG100-6	G1/2"	100	0 - 6	
	MANRG100-10			0 - 10	
	MANRG100-16			0 - 16	
	MANRG100-40			0 - 40	
	MANRG100-100			0 - 100	

MANÓMETRO EN ACERO INOX PARA LA INDUSTRIA QUÍMICA STAINLESS STEEL PRESSURE GAUGES FOR THE CHEMISTRY

Aplicaciones - Applications

Para gases y líquidos agresivos, que no sean altamente viscosos, no cristalicen y en ambientes agresivos.
Este instrumento deberá ser utilizado según las recomendaciones de la norma EN 837-1.
Temperatura máxima de trabajo 80°C.

For gaseous and liquid media which are not highly viscous and do not crystallize.
Suitable for aggressive environments.
These instruments must be used in accordance with the safety recommendations of EN 837-1.
Maximum temperature 80°C.

Los datos técnicos y gráficos no son vinculantes. - Drawing and technical date are not binding.

Manómetro totalmente fabricado en acero inoxidable, con glicerina, caja en INOXIDABLE AISI 304, sistema de medida en INOXIDABLE AISI 316, dial y aguja indicadora en aluminio, rosca radial cilíndrica BSPP
Stainless steel unfilled pressure gauge for the chemistry with INOX AISI 304 case, spring & hub in INOX AISI 316, dial and pointer in aluminium, bottom connection, BSPP thread

MANRGX	REFERENCIA	Rosca conexión Connection thread	Ø Caja Ø Case	Escala Range (bar)	Precisión Accuracy
	MANRGX63-2,5	G1/4"	63	0 - 2,5	Clase / class 1,6
	MANRGX63-4			0 - 4	
	MANRGX63-6			0 - 6	
	MANRGX63-10			0 - 10	
	MANRGX63-16			0 - 16	
	MANRGX63-25			0 - 25	
	MANRGX63-40			0 - 40	
	MANRGX63-60			0 - 60	
	MANRGX63-100			0 - 100	
	MANRGX100-6	G1/2"	100	0 - 6	
	MANRGX100-10			0 - 10	
	MANRGX100-16			0 - 16	
	MANRGX100-40			0 - 40	
	MANRGX100-100			0 - 100	

PISTOLA DE ALUMINIO "PSF" - "PSF" ALUMINIUM AIR GUN

Datos Técnicos	
Aplicaciones	Neumática en ambientes oxidantes o en contacto con fluidos como agua, grasas y aceites
Materiales utilizados	Cuerpo: aluminio barnizado
	Botón: PA-11
	Puntera: NBR
	Empaquetadura: NBR
	Muelle: inox AISI 302
Presión de trabajo	12 Bar
Características	Se adapta a cualquier tipo de aplicación en la industria, dado que su principal aplicación es la limpieza de elementos que contengan polvo, virutas, suciedad, etc Óptimo rendimiento. Gran caudal
Accesorios disponibles	Alargaderas: latón (códigos L-150 y L-225)
	Puntera en NBR: (código PSF 1010-4)
Producto conforme a la directiva 2002/95/EC RoHS	

Technical specifications	
Applications	Suitable for pneumatics in oxidative environments or in contact with fluids as water, grease & oil.
Materials used	Body: painted aluminium
	Button: PA-11
	Standard nozzle: NBR
	Seals: NBR
	Spring: inox AISI 302
Working pressure	12 Bar
Advantages	Suitable for each kind of industry as it's used for cleaning elements which contain dust, bacteria and oils. good performance and big capacity
Available accessories	Nozzles: brass (codes L-150 & L-225)
	NBR: (code PSF1010-4)
Products in conformity with the directive 2002/95/EC RoHS	

Los datos técnicos y gráficos no son vinculantes. - Drawing and technical date are not binding.

Pistola de soplado en aluminio rosca hembra cilíndrica BSPP • Aluminium air gun with female BSPP thread			
PSF	REFERENCIA	Rosca hembra	Dimensiones aproximadas Approximate dimensions
	PSF-1010	G1/4"	120 x 62 x 25

Alargadera en latón para PSF 1010 • Brass nozzles for PSF 1010			
L150 Y L225	REFERENCIA	L(mm)	Rosca macho
	L-150	158	G1/8"
	L-225	233	G1/8"

Puntera en NBR para PSF 1010 • NBR nozzle for PSF 1010			
PSF 1010-4	REFERENCIA	L(mm)	Rosca macho
	PSF-1010-4	20	G1/8"

PISTOLA "IMOPS" - "IMOPS" AIR GUN

Designación de la referencia - Model designation

IMOPS	10
Código Code	Longitud de la boquilla Nozzle length
10	10 mm
100	100 mm

Datos Técnicos	
Aplicaciones	Neumática
Materiales utilizados	Plástico y latón
Rosca	Gas Cilíndrica BSPP
Alimentación	Progresiva
Presión de trabajo	De 0 a 10 Bar
Temperatura de trabajo	De 0°C a 60°C
Producto conforme a la directiva 2002/95/EC RoHS	

Technical specifications	
Applications	Pneumatics
Materials used	Plastic and brass
Threads	Cylindrical gas BSPP
Supply	Progressive
Working pressure	From 0 to 10 Bar
Working temperature	From 0°C to 60°C
Products in conformity with the directive 2002/95/EC RoHS	

Los datos técnicos y gráficos no son vinculantes. - Drawing and technical date are not binding.

Pistola de soplado con boquilla en latón rosca hembra cilíndrica BSPP • Air gun with BSPP thread in brass

IMOPS	REFERENCIA	ØD	Rosca hembra	L (mm)	E (mm)	N (mm)	J (mm)	Peso Weight(g)	
	IMOPS-10	25	G1/4"	142,3	105,5	24	-	115,1	
	IMOPS-100	25	G1/4"	142,3	105,5	24	73,5	123,1	

NUEVO

PISTOLA DE SOPLADO EN ALUMINIO CON BOQUILLA EFECTO VENTURI ALUMINIUM BLOW GUN WITH NOZZLE VENTURI EFFECT

Datos Técnicos	
Aplicaciones	Neumática
Materiales utilizados	Aluminio anodizado
Rosca	Gas macho cilíndrica BSPP G 1/4"
Presión Máx. de trabajo	12 Bar
Características	Boquilla tipo Venturi
Producto conforme a la directiva 2002/95/EC RoHS	

Technical specifications	
Applications	Pneumatics
Materials used	Anodized aluminum
Threads	Male BSPP G 1/4"
Maximum working pressure	12 bar
Features	Venturi nozzle
Products in conformity with the directive 2002/95/EC RoHS	

Los datos técnicos y gráficos no son vinculantes. - Drawing and technical date are not binding.

Pistola de soplado en aluminio con boquilla efecto venturi • Aluminium blow gunt with nozzle venturi effect

PS10-V	REFERENCIA	Rosca macho	Peso Weight(g)
	PS10-V	G1/4"	213,1

**PISTOLA DE SEGURIDAD "IPS-SR-OSHA" SEGÚN NORMA OSHA
 SAFETY "IPS-SR-OSHA" BLACK AIR BLOW GUN OSHA COMPLIANT**

Datos Técnicos	
Aplicaciones	Neumática
Rosca	Gas hembra cilíndrica BSPP
Presión máxima de trabajo	12 Bar
Temperatura de trabajo	De -10°C a +60°C
Consumo a 8 Bar	330 l/min
Nivel de ruido a 6/8 bar	76/78 dB
Materiales utilizados	Empuñadura: acetal
	Válvula: acetal
	Junta: NBR
	Alargadera: acero inoxidable
Color	Azul
Características	Cumple la norma OSHA
	Regulación progresiva del flujo del aire
	Empuñadura ergonómica
	Estructura ligera y robusta, antiimpactos
Producto conforme a la directiva 2002/95/EC RoHS	

Technical specifications	
Applications	Pneumatics
Threads	Female cylindrical gas BSPP
Max working pressure	12 bar
Working temperature	From -25°C to +85°C
Use at 8 Bar	330 l/min
Sonorous emission at 6/8 bar	76/78 dB
Materials used	Handle: acetal
	Valve: acetal
	Seal: NBR
	Extension: stainless steel
Color	Blue
Advantages	OSHA compliant
	Progressive regulation of the air flow
	Ergonomic grip
	Light and sturdy body
Products in conformity with the directive 2002/95/EC RoHS	

Los datos técnicos y gráficos no son vinculantes. - Drawing and technical date are not binding.

Pistola de seguridad azul según norma OSHA • Safety blue air blow gun OSHA compliant

IPS-SR-OSHA	REFERENCIA	Rosca hembra	Peso Weight(g)
	IPS-SR-OSHA	G1/4"	108

PISTOLAS DE SOPLADO • AIR GUNS

Datos Técnicos	
Aplicaciones	Neumática
Rosca	Gas hembra cilíndrica BSPP
Presión de trabajo	16 Bar
Temperatura de trabajo	de -10°C a +80°C
Consumo a 8 Bar	Máx. 380 l/m
Nivel de ruido a 8 Bar	85dB
Materiales utilizados	Empuñadura: acetal
	Válvula: acetal
	Junta: NBR
	Alargadera: acero inoxidable
Color	Azul
Características	Regulación progresiva del flujo del aire
	Empuñadura ergonómica
	Estructura ligera y robusta, antiimpactos
Producto conforme a la directiva 2002/95/EC RoHS	

Technical specifications	
Applications	Pneumatics
Threads	Female cylindrical gas BSPP
Max working pressure	16 Bar
Working temperature	From -10°C to +80°C
Use at 8 Bar	Max 380 l/m
Sonorous emission at 8 Bar	85 dB
Materials used	Handle: acetal
	Valve: acetal
	Seal: NBR
	Extension: stainless steel
Color	Blue
Advantages	Progressive regulation of the air flow
	Ergonomic grip
	Light and sturdy body
Products in conformity with the directive 2002/95/EC RoHS	

Los datos técnicos y gráficos no son vinculantes. - Drawing and technical date are not binding.

Pistola de soplado plástico con alargadera curva • Blue plastic air blow gun with bent pipe

IPS	REFERENCIA	Rosca hembra	Peso Weight(g)
	IPS	G1/4"	103,6

Pistola de soplado plástico con regulador de caudal y alargadera curva • Blue plastic air blow gun with adjustment with bent pipe

IPS-REG	REFERENCIA	Rosca hembra	Peso Weight(g)
	IPS-REG	G1/4"	123

Pistola de soplado plástico con turbo y alargadera curva • Blue plastic air blow gun turbo with bent pipe

IPS-TURBO	REFERENCIA	Rosca hembra	Peso Weight(g)
	IPS-TURBO	G1/4"	112,8

Pistola de soplado plástico con alargadera recta de 300-500 mm • Blue plastic air blow gun turbo with 300-500 mm. straight pipe

IPS-	REFERENCIA	Rosca hembra	Peso Weight(g)
	IPS-30	G1/4"	133,5
	IPS-50	G1/4"	168,5

INFLADOR EURODAINU - EURODAINU TYRE-INFLATING GUN

Datos Técnicos	
Presión de trabajo	de 0,7 a 12 bar.
Presión máxima	15 bar
Diámetro de manómetro	80 mm
Longitud de latiguillo	1,5 m
Gran fiabilidad	
Incluye Certificado de Calibración homologado por la Directiva Europea 86/217/EEC	
Precisión de acuerdo con las tolerancias impuestas por la norma 86/217/CEE	
Producto conforme a la directiva 2002/95/EC RoHS	

Technical specifications	
Reading scale from	0,7 at 12 bar
Maximum pressure	15 bar
Manometer diameter	80 mm
Length pipe	1,5 m
Very good reliabilit	
Accuracy certificate european directive 86/217/EEC	
It will measure and indicate tire pressures within the tolerances of 86/217/EEC standars	
Products in conformity with the directive 2002/95/EC RoHS	

Los datos técnicos y gráficos no son vinculantes. - Drawing and technical date are not binding.

INFL-EURO-03	REFERENCIA	Rosca hembra	Peso Weight(g)
	INFL-EURO-03	G1/4"	721

INFLADOR HOMOLOGADO • PROFESSIONAL TYRE-INFLATING GUN

Manómetro diám. 80, presión máxima 0/10 bar, longitud del latiguillo 100 cm. Tarado según normativa CEE nº 86/217

Manometer diam. 80, operating pressure 0/10 bar, length pipe cm. 100
 The calibration is in to directive CEE nº 86/217

Los datos técnicos y gráficos no son vinculantes. - Drawing and technical date are not binding.

INFL-HOM-01	REFERENCIA	Rosca macho	Peso Weight(g)
	INFL-HOM-01	G1/4"	714

INFLADOR DE ALUMINIO • TYRE-INFLATING GUN

Manómetro diám. 63, presión máxima 0/12 bar, longitud del latiguillo 40 cm.

Manometer diam. 63, operating pressure 0/12 bar, length pipe cm. 40

Los datos técnicos y gráficos no son vinculantes. - Drawing and technical date are not binding.

INFL-AL-02	REFERENCIA	Rosca macho	Peso Weight(g)
	INFL-AL-02	G1/4"	382,4

BOQUILLA EN LATÓN NIQUELADO PARA INFLADOR UNIVERSAL HEAD FOR TYRE-INFLATING NICKEL PLATED BRASS

IMO-BOQ	REFERENCIA	T	Peso Weight(g)
	IMO-BOQ-06	6	22,7
	IMO-BOQ-08	8	23

KIT SOPLADO PARA CABINA DE CAMIÓN • AIR GUN KIT ASSEMBLED WITH FITTINGS

Kit completo para soplado que incluye los siguientes elementos: Espiral de poliuretano diám. 6x4 mm. (disponibles en longitudes de 5,7'5 y 10 m.) con terminación en racor de tuerca moleteada BSP-T 1/4", acoplamiento con muelles para conexión al enchufe rápido, "T" para tubo de 6 mm. con tramo de tubería de poliuretano 6x4 mm., conexión rápida con pasatabiques para tubería de 6x4 mm., y pistola de soplado IMOPS-10

Air gun kit assembled with fittings includes the next items: polyurethane coiled tubing 6x4 mm. (available in lengths 5, 7'5 and 10 m.) ends with compression connection BSPT 1/4", compression connection plug with spring, union tee 6 mm, with polyurethane tube 6x4 mm., bulkhead female quick coupling 6x4 mm., air blow gun code IMOPS-10.

Los datos técnicos y gráficos no son vinculantes. - Drawing and technical date are not binding.

KIT	REFERENCIA	LONGITUD ESPIRAL	Peso Weight(g)
	KIT-50	5	338,4
	KIT-75	7,5	393,8
	KIT-10	10	435,7

NUEVO

KIT PARA DIÓXIDO DE CARBONO CO2 • CO2 KIT

Especial para trabajos en reformas. Para todo tipo de herramienta neumática, totalmente silencioso, no necesita enchufe, prescinde totalmente de compresor.

Incluye: botella de CO2, regulador, espiral con conexiones rápidas, gafas protectoras y maletín de transporte. (Con o sin carga de CO2)

Máxima presión de salida 8 bar
Presión de trabajo 8 bar
Dimensiones 5mmx8mmx2m



TUBERÍAS · Tubes

TUBERÍA DE POLIURETANO · Polyurethane tube

ESPIRAL DE POLIURETANO · Polyurethane coiled tube

TUBERÍA DE POLIAMIDA · Polyamide tube

ESPIRAL DE POLIAMIDA · Polyamide coiled tube

TUBERÍA DE CAUCHO · Rubber hose

TUBERÍA DE PVC PARA AIRE · Flexible hose in PVC

NUEVO TUBERÍA DE CAUCHO REFORZADO · Rubber reinforced hose

TUBERÍA BITUBO DE POLIURETANO · Polyurethane twin tube

TUBERÍA CALIBRADA DE PTFE · PTFE calibrated tube

NUEVO TUBERÍA DE POLIETILENO · Polyethylene tube

TUBERÍA FLEXIBLE PARA COMBUSTIBLES · Hoses for fuels

TUBERÍA PARA LIMPIEZA CON AGUA CALIENTE USO ALIMENTARIO

Hot water cleaning hose food approved

TUBERÍA TRANSPARENTE MALLADA · Transparent flexible PVC hose

TUBERÍA POLIURETANO/PVC REFUERZO TEXTIL · Flexible hose PU/PVC

NUEVO TUBERÍA DE POLIURETANO ANTIABRASIVO · Antiabrasive polyurethane hose

TUBERÍA ANTIESTÁTICA · Antistatic tube

TUBERÍA AUTOAJUSTABLE AS · AS self fastening tube

NUEVO TUBERÍA AUTOAJUSTABLE AS PARA ROBÓTICA · AS self fastening tube for robotics

RACORES PARA TUBERÍA AUTOAJUSTABLE AS · Steel barb connectors for self fastening tubes

TUBERÍA DE POLIURETANO ANTICHISPAS S/DIN 5510-2

Antisparking polyurethane tube DIN 5510-2

ENROLLADORES AUTOMÁTICOS · Retractable hose reels

NUEVO KIT DE SEGURIDAD ANTIVIBRACIONES · Safety antivibrations kit

TUBERÍA DE POLIURETANO • POLYURETHANE TUBE

Datos Técnicos	
Descripción	Tubería de poliuretano de 98 shores en base de Poliester.
	Muy flexible, incluso a bajas temperaturas
Características	Temperatura de trabajo: De 0 °C a +60 °C.
	Buena resistencia a la abrasión, vibraciones, fatiga del material e inclemencias metereológicas.
	Buena resistencia a hidrocarburos, agua, aceites y productos químicos en moderadas disoluciones.
	Exenta de siliconas.
Aplicaciones	Neumática, automoción, maquinaria, talleres, instrumentación, etc. Recomendado especialmente para aplicaciones con racor automático.
	Tubería en color negro, especialmente indicada para aplicaciones a la intemperie.

Technical specifications	
Description	Polyurethane tube 98 shores on polyster basis.
	Very flexible, even at low temperatures.
Specifications	Working temperature: From 0 °C to +60 °C
	Good performance against abrasion, vibrations, deterioration and weather conditions
	Appropriate to use with fuels, water, oils and chemical products in moderate disolutions
	Silicone free
Applications	Pneumatic, automotion, machinery, garage, instrumentation, etc. Special recomended for one touch fittings.
	Black tube is suitable for outdoor aplications.

Los datos técnicos y gráficos no son vinculantes. - Drawing and technical date are not binding.

PRESENTACIÓN EN ROLLOS DE 50 / 100 M. Y DISPENSADORES DE 25 M. DISPONIBLE EN VARIOS COLORES. VER TABLA	Ø TUBO EXT X INT (MM)	TOLERANCIAS (MM)	PRESIÓN DE TRABAJO A 23 °C (BAR)	RADIO MÍNIMO DE CURVATURA (MM)	COLOR	REFERENCIA DISPENSADORES DE 25 M.	REFERENCIA ROLLOS DE 100 M.			
FACTOR DE CORRECCIÓN DE LA PRESIÓN INDICADA EN TABLA EN FUNCIÓN DE LA TEMPERATURA A -20 °C: X 1,87 SOBRE VALOR DE TABLA A 0 °C: X 1,40 SOBRE VALOR DE TABLA A 23 °C: X 1,00 SOBRE VALOR DE TABLA A 30 °C: X 0,84 SOBRE VALOR DE TABLA A 40 °C: X 0,70 SOBRE VALOR DE TABLA A 50 °C: X 0,60 SOBRE VALOR DE TABLA A 60 °C: X 0,52 SOBRE VALOR DE TABLA A 70 °C: X 0,47 SOBRE VALOR DE TABLA	4 x 2,5	±0,1	10	12	Azul	DPU0425-AZ	TPU0425-AZ			
					Azul traslúcido	DPU0425-AT	TPU0425-AT			
					Transparente	DPU0425-TR	TPU0425-TR			
					Negro	DPU0425-NE	TPU0425-NE			
					Amarillo	DPU0425-AM	TPU0425-AM			
	Rojo	DPU0425-RO	TPU0425-RO							
	Plateado	DPU0425-PL	TPU0425-PL							
	Verde	DPU0425-VE	TPU0425-VE							
	6 x 4	±0,1	8,5	15	Azul	DPU0640-AZ	TPU0640-AZ			
					Azul traslúcido	DPU0640-AT	TPU0640-AT			
Transparente					DPU0640-TR	TPU0640-TR				
Negro					DPU0640-NE	TPU0640-NE				
Amarillo					DPU0640-AM	TPU0640-AM				
Rojo					DPU0640-RO	TPU0640-RO				
Plateado					DPU0640-PL	TPU0640-PL				
Verde					DPU0640-VE	TPU0640-VE				
8 x 5,5					±0,1	8,5	20	Azul	DPU0855-AZ	TPU0855-AZ
								Azul traslúcido	DPU0855-AT	TPU0855-AT
	Transparente	DPU0855-TR	TPU0855-TR							
	Negro	DPU0855-NE	TPU0855-NE							
	Amarillo	DPU0855-AM	TPU0855-AM							
	Rojo	DPU0855-RO	TPU0855-RO							
	Plateado	DPU0855-PL	TPU0855-PL							
	Verde	DPU0855-VE	TPU0855-VE							
	10 x 7	±0,15	8	25				Azul	DPU1070-AZ	TPU1070-AZ
								Azul trasl.	DPU1070-AT	TPU1070-AT
Transparente					DPU1070-TR	TPU1070-TR				
Negro					DPU1070-NE	TPU1070-NE				
Amarillo					DPU1070-AM	TPU1070-AM				
Rojo					DPU1070-RO	TPU1070-RO				
Verde					DPU1070-VE	TPU1070-VE				
12 x 9					±0,15	7	35	Azul	DPU1290-AZ	TPU1290-AZ
								Azul trasl.	DPU1290-AT	TPU1290-AT
								Transparente	DPU1290-TR	TPU1290-TR
	Negro	DPU1290-NE	TPU1290-NE							
	Amarillo	DPU1290-AM	TPU1290-AM							
	Rojo	DPU1290-RO	TPU1290-RO							
	Verde	DPU1290-VE	TPU1290-VE							
	14 x 10	±0,15	8	45				Azul	----	TPU1410-AZ (*)
	16 x 12	±0,15	8,5	60				Azul	----	TPU1612-AZ (*)



(*) Sólo rollos de 50 m.

ESPIRAL DE POLIURETANO - POLYURETHANE COILED TUBE

Datos Técnicos	
Descripción	Tubería de poliuretano de 95 shores.
	Muy flexible, incluso a bajas temperaturas.
	Reducido peso y tamaño.
	Excelente resistencia a la tracción y vibraciones.
	Se suministra montada con racores fijo y giratorio en los extremos, excepto la espiral de diámetro 4 que no lleva racores.
Características	Presión máxima de trabajo: 10 bar a 23° C.
	Temperatura de trabajo: De -20 °C a +70 °C.
Aplicaciones	Herramienta neumática, pistolas de soplado, robots industriales, estaciones de servicio y aplicaciones neumáticas en general.

Technical specifications	
Description	Polyurethane tube 95 shores.
	Very flexible, even at low temperatures.
	Reduced weight and size.
	Excellent resistance to fatigue stress and vibrations.
	Assembled with joints rotating and fixed, except tube of diameter 4
Specifications	Maximum working pressure: 10 bar at 23° C.
	Working temperature: From -20 °C to +70 °C.
Applications	Pneumatic tools, air blow guns, industrial equipment, service stations and general pneumatic applications.

Los datos técnicos y gráficos no son vinculantes. - Drawing and technical date are not binding.

DISPONIBLE EN COLORES AMARILLO Y AZUL	Ø TUBO EXT X INT (MM)	ROSCA EN LOS EXTREMOS	LONGITUD DE TUBO (M)	LONG. ÚTIL APROX (M)	COLOR	REFERENCIA
FACTOR DE CORRECCIÓN DE LA PRESIÓN INDICADA EN TABLA, EN FUNCIÓN DE LA TEMPERATURA A -20 °C: X 1,87 SOBRE VALOR DE TABLA A 0 °C: X 1,40 SOBRE VALOR DE TABLA A 23 °C: X 1,00 SOBRE VALOR DE TABLA A 30 °C: X 0,84 SOBRE VALOR DE TABLA A 40 °C: X 0,70 SOBRE VALOR DE TABLA A 50 °C: X 0,60 SOBRE VALOR DE TABLA A 60 °C: X 0,52 SOBRE VALOR DE TABLA A 70 °C: X 0,47 SOBRE VALOR DE TABLA	4 x 2,5	Sin racor en los extremos	0,7	0,5	Azul	EPU0407-AZ
			1,0	0,7		EPU0410-AZ
			2,0	1,5		EPU0420-AZ
			7,0	5,0		EPU0470-AZ
	6 x 4	Rosca macho R 1/4"	3,5	2,0	Azul	EPU063514-AZ
			5,0	4,0		EPU065014-AZ
			7,5	6,0		EPU067514-AZ
			10,0	8,0		EPU0610014-AZ
	8 x 5	Rosca macho R 1/4"	3,5	2,0	Azul	EPU083514-AZ
			5,0	4,0	Azul	EPU085014-AZ
			7,5	6,0	Amarillo	EPU085014-AM
			10,0	8,0	Azul	EPU087514-AZ
10,0			8,0	Amarillo	EPU087514-AM	
10,0			8,0	Azul	EPU0810014-AZ	
10 x 6,5	Rosca macho R 1/4"	3,5	2,0	Amarillo	EPU0810014-AM	
		5,0	4,0	Azul	EPU103514-AZ	
		7,5	6,0	Amarillo	EPU103514-AM	
		10,0	8,0	Azul	EPU105014-AZ	
		10,0	8,0	Amarillo	EPU105014-AM	
		10,0	8,0	Azul	EPU107514-AZ	
		10,0	8,0	Amarillo	EPU107514-AM	
		10,0	8,0	Azul	EPU1010014-AZ	
12 x 8	Rosca macho G 3/8"	3,5	2,0	Amarillo	EPU1010014-AM	
		5,0	4,0	Azul	EPU123538-AZ	
		7,5	6,0	Amarillo	EPU123538-AM	
		10,0	8,0	Azul	EPU125038-AZ	
		10,0	8,0	Amarillo	EPU125038-AM	
		10,0	8,0	Azul	EPU127538-AZ	
		10,0	8,0	Amarillo	EPU127538-AM	
		10,0	8,0	Azul	EPU1210038-AZ	



Consultar con nuestro Departamento Técnico las dimensiones de estas espirales.

Consultar disponibilidad de espirales en otros colores, medidas y racores diferentes a los indicados.

TUBERÍA DE POLIAMIDA • POLYAMIDE TUBE

Datos Técnicos	
Características	Temperatura de trabajo: De -40 °C a +100 °C.
	La presión de estallido es 3 veces la presión de trabajo.
	Buena resistencia a las vibraciones y fatiga del material.
	Excelente propiedades físicas y de resistencia a productos químicos.
	Exenta de siliconas.
	PA 12
Aplicaciones	Neumática, hidráulica, gases, aceites, hidrocarburos, agua, etc.
	Tubería en color negro, especialmente indicada para aplicaciones a la intemperie.

Technical specifications	
Specifications	Working temperature: From -40 °C to +100 °C.
	Burst pressure is 3 times the working pressure.
	Good performance against vibrations and deterioration.
	Excellent physical performances and good resistance against chemicals.
	Silicone free.
	PA 12
Applications	Pneumatic, hydraulic, gases, oils, fuels, water, etc.
	Black tube is suitable for outdoor applications.

Los datos técnicos y gráficos no son vinculantes. - Drawing and technical data are not binding.

PRESENTACIÓN EN ROLLOS DE 50 / 100 M. Y DISPENSADORES DE 25 M.	Ø TUBO EXT X INT (MM)	PRESIÓN DE TRABAJO A 23 °C (BAR)	RADIO MÍNIMO DE CURVATURA (MM)	COLOR	REFERENCIA DISPENSADORES DE 25 M.	REFERENCIA ROLLOS DE 100 M.
DISPONIBLE EN VARIOS COLORES. VER TABLA	4 x 2	45	20	Blanco	DP04-B	TP-2x4-B
				Negro	DP04-N	TP-2x4-NE
FACTOR DE CORRECCIÓN DE LA PRESIÓN INDICADA EN TABLA, EN FUNCIÓN DE LA TEMPERATURA A -20 °C: X 1,87 SOBRE VALOR DE TABLA A 0 °C: X 1,40 SOBRE VALOR DE TABLA A 23 °C: X 1,00 SOBRE VALOR DE TABLA A 30 °C: X 0,84 SOBRE VALOR DE TABLA A 40 °C: X 0,70 SOBRE VALOR DE TABLA A 50 °C: X 0,60 SOBRE VALOR DE TABLA A 60 °C: X 0,52 SOBRE VALOR DE TABLA A 70 °C: X 0,47 SOBRE VALOR DE TABLA	4 x 2,7	26	26	Blanco	DP0427-B	TP-2,7x4-B
	5 x 3	34	25	Blanco	DP0427-A	TP-2,7x4-A
	6 x 3	44	30	Negro	DP05-B	TP-3x5-B
	6 x 4	27	35	Negro	DP0603-N	TP-3x6-NE
				Blanco	DP06-B	TP-4x6-B
				Azul	DP06-A	TP-4x6-A
	8 x 6	19	65	Negro	DP06-N	TP-4x6-NE
				Blanco	DP08-B	TP-6x8-B
				Azul	DP08-A	TP-6x8-A
	9 x 6	27	45	Negro	DP08-N	TP-6x8-NE
				Blanco	DP09-N	TP-6x9-NE
				Negro	DP10-B	TP-8x10-B
10 x 8	15	100	Azul	DP10-A	TP-8x10-A	
			Negro	DP10-N	TP-8x10-NE	
			Blanco	DP12-B	TP-10x12-B (*)	
12 x 10	12	125	Azul	DP12-A	TP-10x12-A (*)	
			Negro	DP12-N	TP-10x12-NE (*)	
			Blanco	-----	TP-11x14-B (*)	
14 x 11	12	160	Negro	-----	TP-11x14-NE (*)	
			Blanco	-----	TP-12x15-B (*)	
			Negro	-----	TP-12x15-NE (*)	
15 x 12	11	190	Blanco	-----	TP-13x16-B (*)	
			Negro	-----	TP-13x16-NE (*)	
			Blanco	-----	TP-14x18-B (*)	
16 x 13	11	210	Negro	-----	TP-14x18-NE (*)	
			Blanco	-----	TP-16x20-B (*)	
			Negro	-----	TP-16x20-NE (*)	
18 x 14	11	230	Negro	-----	TP-18x20-NE (*)	
20 x 16	11	250	Negro	-----	TP-20x25-NE (*)	



Ø TUBO EXT X INT (pulgadas)	Ø EXT (MM)	Ø INT (MM)	PRESIÓN DE TRABAJO A 20 °C (BAR)	RADIO MÍNIMO DE CURVATURA (MM)	COLOR	REFERENCIA ROLLOS DE 100 M.
1/4 x 11/64 "	6,4	4,4	25	30	Negro	TP-1/4-NE
3/8 x 19/64 "	9,5	7,5	16	60	Negro	TP-3/8-NE
1/2 x 3/8 "	12,7	9,5	19	75	Negro	TP-1/2-NE (*)

(*) Sólo rollos de 50 m.

ESPIRAL DE POLIAMIDA - POLYAMIDE COILED TUBE

TUBO EN COLOR AZUL	Ø TUBO EXT X INT (MM)	PRESIÓN DE TRABAJO A 23 °C (BAR)	ROSCA EN LOS EXTREMOS	LONGITUD DE TUBO (M)	LONGITUD ÚTIL APROX. (M)	REFERENCIA ROLLOS DE 100 M.	
FACTOR DE CORRECCIÓN DE LA PRESIÓN INDICADA EN TABLA, EN FUNCIÓN DE LA TEMPERATURA A -20 °C: X 1,87 SOBRE VALOR DE TABLA A 0 °C: X 1,40 SOBRE VALOR DE TABLA A 23 °C: X 1,00 SOBRE VALOR DE TABLA A 30 °C: X 0,84 SOBRE VALOR DE TABLA A 40 °C: X 0,70 SOBRE VALOR DE TABLA A 50 °C: X 0,60 SOBRE VALOR DE TABLA A 60 °C: X 0,52 SOBRE VALOR DE TABLA A 70 °C: X 0,47 SOBRE VALOR DE TABLA	6 x 4	27	Rosca macho R 1/4"	3,0	2,0	EP-4x6-3 1/4	
				5,0	3,5	EP-4x6-5 1/4	
				7,5	5,0	EP-4x6-7,5 1/4	
				10,0	7,0	EP-4x6-10 1/4	
				15,0	10,0	EP-4x6-15 1/4	
				30,0	20,0	EP-4x6-30 1/4	
	8 x 6	19	Sin racores	30,0	20,0	EP-4x6-30	
				Rosca macho R 1/4"	3,0	2,0	EP-6x8-3 1/4
					5,0	3,5	EP-6x8-5 1/4
					7,5	5,0	EP-6x8-7,5 1/4
					10,0	7,0	EP-6x8-10 1/4
					15,0	10,0	EP-6x8-15 1/4
		30,0	20,0		EP-6x8-30 1/4		
		Rosca macho R 3/8"	3,0	2,0	EP-6x8-3 3/8		
5,0			3,5	EP-6x8-5 3/8			
7,5			5,0	EP-6x8-7,5 3/8			
10,0			7,0	EP-6x8-10 3/8			
15,0			10,0	EP-6x8-15 3/8			
30,0			20,0	EP-6x8-30 3/8			
10 x 8		15	Sin racores	30,0	20,0	EP-6x8-30	
	Rosca macho R 1/4"			3,0	2,0	EP-8x10-3 1/4	
				5,0	3,5	EP-8x10-5 1/4	
				7,5	5,0	EP-8x10-7,5 1/4	
				10,0	7,0	EP-8x10-10 1/4	
				15,0	10,0	EP-8x10-15 1/4	
		30,0	20,0	EP-8x10-30 1/4			
	Rosca macho R 3/8"	3,0	2,0	EP-8x10-3 3/8			
		5,0	3,5	EP-8x10-5 3/8			
		7,5	5,0	EP-8x10-7,5 3/8			
		10,0	7,0	EP-8x10-10 3/8			
		15,0	10,0	EP-8x10-15 3/8			
		30,0	20,0	EP-8x10-30 3/8			
	Sin racores	30,0	20,0	EP-8x10-30			
Rosca macho R 3/8"		3,0	2,0	EP-10x12-3 3/8			
		5,0	3,5	EP-10x12-5 3/8			
		7,5	5,0	EP-10x12-7,5 3/8			
		10,0	7,0	EP-10x12-10 3/8			
		15,0	10,0	EP-10x12-15 3/8			
	30,0	20,0	EP-10x12-30 3/8				
Sin racores	30,0	20,0	EP-10x12-30				
	Rosca macho R 1/2"	5,0	3,5	EP-12x15-5 1/2			
		7,5	5,0	EP-12x15-7,5 1/2			
		10,0	7,0	EP-12x15-10 1/2			
		15,0	10,0	EP-12x15-15 1/2			
		30,0	20,0	EP-12x15-30 1/2			
30,0		20,0	EP-12x15-30				



Consultar con nuestro Departamento Técnico las dimensiones de estas espirales.

Consultar disponibilidad de espirales en otros colores, medidas y racores diferentes a los indicados, así como la posibilidad de montajes especiales con otros fabricados IMOPAC.

TUBERÍA DE CAUCHO - RUBBER HOSE

Datos Técnicos	
Color	Exterior azul, interior negro.
Temperatura de trabajo	-50 °C +120 °C.
Presión de trabajo	20 bar.
Presión de rotura	60 bar.
Características	Tubo interior impermeable en caucho sintético negro. Refuerzo en hilo de poliéster helicoidal. Capa exterior bandelada en caucho sintético de color azul.
	Ignífuga. Muy flexible, incluso a bajas temperaturas.
	Cumple la norma EN 559 - ISO 3821. Exenta de siliconas.
Aplicaciones	Aire comprimido, compresores, equipos de soldadura, uso industrial. Agua.

Technical specifications	
Colour	Outside blue, inside black.
Working temperature	-50 °C +120 °C.
Working pressure	20 bar.
Pressure breakage	60 bar.
Specifications	Inner hose made of impervious black synthetic rubber. reinforced with helical polyester thread. Outer layer lapped in synthetic rubber blue colour. fireproof.
	Very flexible, even at low temperatures.
	According to EN 559 - ISO 3821. Silicone free
Applications	For compressed air, compressors, welding industry, general appliances in industry and water.

Los datos técnicos y gráficos no son vinculantes. - Drawing and technical data are not binding.

PRESENTACIÓN EN ROLLOS DE 50 M. TUBO EN COLOR AZUL	Ø TUBO EXT X INT (MM)	RADIO MÍNIMO DE CURVATURA (MM)	REFERENCIA
	13x6	35	TUBCA-06
	15x8	45	TUBCA-08
	18x10	70	TUBCA-10
	20x12	80	TUBCA-12
	25x15	100	TUBCA-15
	30x19	150	TUBCA-19
	38x25	160	TUBCA-25

TUBERÍA DE PVC PARA AIRE (AZUL) - FLEXIBLE HOSE IN PVC (BLUE)

Datos Técnicos	
Color	Azul.
Temperatura de trabajo	-10 °C +60 °C.
Presión de trabajo	20 bar.
Presión de rotura	60 bar.
Características	Tubo flexible, interior y exterior en PVC con refuerzo textil de poliéster.
Aplicaciones	Aire comprimido, compresores.

Technical specifications	
Colour	Blue.
Working temperature	-10 °C +60 °C.
Working pressure	20 bar.
Pressure breakage	60 bar.
Specifications	Flexible hose in PVC alloy with braided polyester threads reinforcement.
Applications	For compressed air, compressors.

Los datos técnicos y gráficos no son vinculantes. - Drawing and technical data are not binding.

PRESENTACIÓN EN ROLLOS DE 50 M. TUBO EN COLOR AZUL	Ø TUBO EXT X INT (MM)	REFERENCIA
	11 x 6	TUBAIR06
	13 x 8	TUBAIR08
	15 x 10	TUBAIR10
	17 x 12	TUBAIR12

TUBERÍA DE PVC PARA AIRE (NEGRO) - FLEXIBLE HOSE IN PVC (BLACK)

Datos Técnicos	
Color	Negro.
Temperatura de trabajo	-20 °C +60 °C.
Presión de trabajo	20 bar.
Presión de rotura	60 bar.
Características	Tubo flexible, interior y exterior en PVC con refuerzo textil de poliéster.
Aplicaciones	Aire comprimido, agua.

Technical specifications	
Colour	Black.
Working temperature	-20 °C +60 °C.
Working pressure	20 bar.
Pressure breakage	60 bar.
Specifications	Flexible hose in PVC alloy with braided polyester threads reinforcement.
Applications	For compressed air, water.

Los datos técnicos y gráficos no son vinculantes. - Drawing and technical date are not binding.

PRESENTACIÓN EN ROLLOS DE 50 M.
TUBO EN COLOR NEGRO



Ø TUBO EXT X INT (MM)	REFERENCIA
17 x 8	TUBAIR08-NE
19 x 10	TUBAIR10-NE

NUEVO
TUBERÍA CAUCHO REFORZADO - RUBBER REINFORCED HOSE

Datos Técnicos	
Características	Tubería de caucho natural y sintético resistente al vapor de aceite.
	Refuerzo: Hilos sintéticos de alta resistencia.
	Exterior: Caucho natural, sintético y liso. Resistente a la abrasión, ozono y agentes atmosféricos
	Uso: Aire comprimido y herramientas neumáticas. Especialmente en minas, canteras, construcción y compresores de obra pública.
	Temperatura de trabajo: de -25°C a 80 °C
	Color: Negro
	Presión de trabajo: 20 bar
	Presión de rotura: 64 bar
	Cumple la normativa ISO 1307

Technical specifications	
Specifications	Pipe oil vapor resistant natural and synthetic rubber.
	Reinforcement: high strength synthetic yarns.
	Exterior: natural, synthetic, smooth rubber. Resistant to abrasion, ozone and weathering
	Use: Compressed air and pneumatic tools. Especially in mining, quarrying, construction and public works compressors.
	Working temperature: from -25°C to 80°C
	Color: Black
	Working pressure: 20 bar
	Bursting pressure: 64 bar
	According to ISO 1307

Los datos técnicos y gráficos no son vinculantes. - Drawing and technical date are not binding.

TUBO EN COLOR NEGRO



REFERENCIA	ØD INT(mm)	ØD EXT(mm)	Radio de curvatura(mm)	Longitud(m)	Peso Weight(g/m)
PRESAIR06	6	12	30	100	160
PRESAIR08	8	15	34	100	195
PRESAIR10	10	17	40	100	270
PRESAIR13	13	20	60	50	395
PRESAIR15	15	25	75	50	450
PRESAIR19	19	29	90	20/25/50	585
PRESAIR25	25	36	120	50	890

TUBERÍA BITUBO DE POLIURETANO - POLYURETHANE TWIN HOSE

Datos Técnicos	
Características	Tubería de poliuretano de 98 shores.
	Muy flexible, incluso a bajas temperaturas.
	Temperatura de trabajo: De -20 °C a +70 °C.
	Buena resistencia a la abrasión, vibraciones, fatiga del material e inclemencias metereológicas.
	Buena resistencia a hidrocarburos, agua, aceites y productos químicos en moderadas disoluciones.

Technical specifications	
Specifications	Polyurethane tube 98 shores.
	Very flexible, even at low temperatures.
	Working temperature: From -20 °C to +70 °C.
	Good performance against abrasion, vibrations, deterioration and weather conditions.
	Appropriate to use with fuels, water, oils and chemical products in moderate disolutions.

Los datos técnicos y gráficos no son vinculantes. - Drawing and technical date are not binding.

PRESENTACIÓN EN ROLLOS DE 25 / 50 M. TUBO EN COLOR AZUL / NEGRO	Ø TUBO EXT X INT (MM)	REFERENCIA	PRESENTACIÓN
	4 x 2,5	DPUH0425-AN	Dispensador de 25 m.
		PUH0425-AN	Rollo de 50 m.
	6 x 4	DPUH0640-AN	Dispensador de 25 m.
		PUH0640-AN	Rollo de 50 m.
	8 x 6	DPUH0860-AN	Dispensador de 25 m.
		PUH0860-AN	Rollo de 50 m.

TUBERÍA CALIBRADA DE PTFE - PTFE CALIBRATED TUBE

Datos Técnicos	
Color	Traslúcido opaco.
Temperatura de trabajo	-200 °C +250 °C.
Características	Resistencia casi total a los productos químicos.
	Poder antiadherente. Muy débil coeficiente de rozamiento. Ininflamabilidad. Excelente propiedades dieléctricas. Buenas propiedades mecánicas. Buen comportamiento a la fatiga y a los choques. Resistencia total al envejecimiento.
	No tóxico (certificado FDA). Alto grado de aislamiento térmico y eléctrico.
	Exenta de siliconas.
Aplicaciones	Transferencia de fluidos, rozamiento, mecánica, electricidad, industria electrónica, aislamientos, etc.

Technical specifications	
Colour	Natural.
Working temperature	-200 °C +250 °C.
Specifications	Resistance against almost chemical products.
	Anti-adherent. low friction coefficient. unflammable. resistant against humidity,
	Ultraviolets ray and deteriorations. Good performance against shock and stress.
	Non toxic (FDA certificate). high electrical and thermic isolate grade.
	Silicone free.
Applications	Fluid transfers, isolating, mechanic, electricity, electronic industry, etc.

Los datos técnicos y gráficos no son vinculantes. - Drawing and technical date are not binding.

PRESENTACIÓN EN ROLLOS DE 50 / 100 M. Y DISPENSADORES DE 25 M.

FACTOR DE CORRECCIÓN DE LA PRESIÓN INDICADA EN TABLA, EN FUNCIÓN DE LA TEMPERATURA

A 23 °C: X 1,00
 SOBRE VALOR DE TABLA
 A 50 °C: X 0,50
 SOBRE VALOR DE TABLA
 A 100 °C: X 0,35
 SOBRE VALOR DE TABLA
 A 150 °C: X 0,30
 SOBRE VALOR DE TABLA
 A 200 °C: X 0,10
 SOBRE VALOR DE TABLA

Ø TUBO EXT X INT (MM)	REFERENCIA	PRESIÓN DE TRABAJO A 23 °C (BAR)	PRESIÓN DE ESTALLIDO A 23 °C (BAR)	RADIO MÍNIMO DE CURVATURA (MM)
4 x 2	IMOPTFE04	56	170	16
4 x 3	IMOPTFE03	18	55	32
5 x 3	IMOPTFE05	36	110	25
6 x 4	IMOPTFE06	28	84	36
8 x 6	IMOPTFE08	18	56	64
9 x 6	IMOPTFE09	28	84	54
10 x 8	IMOPTFE10	14	42	100
12 x 10	IMOPTFE12	11	34	144



Consultar disponibilidad de tubería y espirales de PTFE en otros colores



NUEVO**TUBERÍA DE POLIETILENO - POLYETHYLENE TUBE**

Datos Técnicos	
Color	Natural, negro, blanco, rojo o azul.
Temperatura de trabajo	-29 °C +66 °C.
Características	Amplia compatibilidad química.
	Tubo fabricado con materiales que cumplen para FDA y no son contaminantes.
Aplicaciones	Adecuado para la purificación del agua, acondicionadores de agua, máquinas de hielo, sistemas de nebulización y aplicaciones en contacto con alimentos.

Technical specifications	
Colour	Natural, black, white, red or blue.
Working temperature	-29 °C +66 °C.
Specifications	Broad chemical compatibility.
	Tubing is made from FDA compliant and not contaminating materials.
Applications	Suitable for water purification, water conditioners, ice makers, misting systems and food contact applications.

Los datos técnicos y gráficos no son vinculantes. - Drawing and technical data are not binding.

Tubo polietileno - métrica • Metric polyethylene tube

PE	REFERENCIA	O.D.	I.D.	Tolerancia	Máx. Presión
	PE0425	4	2,5	+/- 0,1	15,9 bar
	PE0640	6	4	+/- 0,1	15,9 bar
	PE0860	8	6	+/- 0,1	11,8 bar
	PE1070	10	7	+/- 0,1	11,8 bar
	PE1290	12	9	+/- 0,1	11,8 bar

Tubo polietileno - pulgadas • Inch polyethylene tube

PE	REFERENCIA	O.D.	I.D.	Tolerancia	Máx. Presión
	PE5/32	5/32	3,97	+/- 0,1	15,9 bar
	PE3/16	3/16	4,76	+/- 0,1	15,9 bar
	PE1/4	1/4	6,35	+/- 0,1	15,9 bar
	PE5/16	5/16	7,94	+/- 0,1	11,8 bar
	PE3/8	3/8	9,52	+/- 0,1	11,8 bar
	PE1/2	1/2	12,7	+/- 0,1	11,8 bar

TUBERÍA FLEXIBLE PARA COMBUSTIBLES - HOSES FOR FUELS

Datos Técnicos	
Color	Negro.
Temperatura de trabajo	-30 °C +120 °C.
Presión de trabajo	10 bar.
Presión de estallido	30 bar.
Características	Tubo flexible para combustible con revestimiento exterior textil. Ignífugo. Cumple la norma DIN 73379 B. Con Certificado de Homologación.
Aplicaciones	Uso industrial. Transferencia de combustible. Industria del automóvil. Alimentación e inyección de combustible en motores de explosión.

Technical specifications	
Colour	Black.
Working temperature	-30 °C +120 °C.
Working pressure	10 bar.
Breakage pressure	30 bar.
Specifications	Fuel hose with textile covering. fireproof. according with specifications DIN 73379 B. with homologation certificate.
Applications	Fuel and gas supply. transport of fuel in the car motorcycle and shipyard fields. suitable for carburettor fuel feeding

Los datos técnicos y gráficos no son vinculantes. - Drawing and technical date are not binding.

PRESENTACIÓN EN DISPENSADORES DE 25 M. PARA OTRAS LONGITUDES, CONSULTAR DISPONIBILIDAD

Ø TUBO EXT X INT (MM)	REFERENCIA	RADIO DE CURVATURA MÍNIMO (MM)	PESO APROXIMADO (KG/ML)
7 x 3	TUBCOMB-03	64	0,10
10 x 5	TUBCOMB-05	89	0,25
12 x 7	TUBCOMB-07	102	0,30
15 x 9	TUBCOMB-09	114	0,36

TUBERÍA PARA LIMPIEZA CON AGUA CALIENTE USO ALIMENTARIO - HOT WATER CLEANING HOSE FOOD APPROVED

Datos Técnicos	
Color	Exterior azul, interior blanco
Temperatura de trabajo	-40 °C +130 °C
Presión de trabajo	20 bar.
Presión de rotura	60 bar.
Características	Tubo interior en EPDM blanco, liso, estable térmicamente y resistente a los detergentes. Refuerzo textil. Cubierta exterior en EPDM azul, resistente a los agentes atmosféricos. Atóxico. Calidad alimentaria.
Aplicaciones	Tubo flexible para limpieza con agua caliente en la industria alimentaria, lavado de pavimentos y otras superficies en industrias del sector alimentario

Technical specifications	
Colour	Outside blue, inside white
Working temperature	-40 °C +130 °C.
Working pressure	20 bar.
Pressure breakage	60 bar.
Specifications	Inner hose made of EPDM white, reinforced with helical polyester thread, outer layer lapped in EPDM, food stuff quality, taste and odour free.
Applications	Flexible hose for use with hot water in cleaning applications in food processing plants.

Los datos técnicos y gráficos no son vinculantes. - Drawing and technical date are not binding.

PRESENTACIÓN EN ROLLOS DE 50 M. APROX.

TUBO EN COLOR AZUL

Ø TUBO EXT X INT (MM)	REFERENCIA	RADIO MÍNIMO DE CURVATURA (MM)	PESO APROXIMADO (KG / M)
17 x 10	TLIMP-10	70	0,198
20 x 12	TLIMP-12	90	0,264
25 x 15,7	TLIMP-16	100	0,315
29 x 19	TLIMP-19	120	0,400
38 x 25,4	TLIMP-25	160	0,590

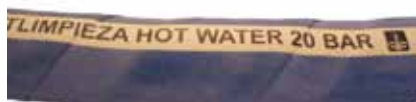

TUBERÍA TRANSPARENTE MALLADA - TRANSPARENT FLEXIBLE PVC HOSE

Datos Técnicos	
Color	Transparente.
Temperatura de trabajo	-10 °C +60 °C.
Presión de trabajo	Ver tabla.
Presión de rotura	Ver tabla.
Características	Tubo flexible fabricado en PVC plastificado con refuerzo en hilo textil de poliéster. Resistente a los agentes atmosféricos y a gran parte de productos químicos.
Aplicaciones	Aire comprimido, conducción de líquidos alimenticios. Cumple normas D.M. 21/3/1973 y sucesivas modificaciones.

Technical specifications	
Color	Transparent.
Working temperature	-10 °C +60 °C.
Working pressure	See table.
Pressure breakage	See table.
Specifications	Flexible hose in PVC with braided polyester threads reinforcement. resistant to atmospherical agents and to most chemicals.
Applications	For compressed air and alimentary liquids. approved for foodstuffs as D.M. 21/3/1973 and further changes.

Los datos técnicos y gráficos no son vinculantes. - Drawing and technical date are not binding.

PRESENTACIÓN EN ROLLOS DE 50 M.	Ø TUBO EXT X INT (MM)	PRESIÓN DE TRABAJO (BAR)	PRESIÓN DE ROTURA (BAR)	REFERENCIA
TRANSPARENTE	10 x 4	18	54	TUBTRANS4
	11 x 6			TUBTRANS6
	13 x 8			TUBTRANS8
	15 x 10	15	45	TUBTRANS10
	17 x 12			TUBTRANS12
	21 x 16			TUBTRANS16
	25 x 19	10	30	TUBTRANS19
	32 x 25			TUBTRANS25
	38 x 30			TUBTRANS30



TUBERÍA POLIURETANO/PVC REFUERZO TEXTIL- FLEXIBLE HOSE PU/PVC

Datos Técnicos	
Color	Interior y exterior en azul claro
Temperatura de trabajo	-25 °C +60 °C.
Presión de trabajo	20 bar.
Presión de rotura	Ver tabla.
Características	Tubo flexible en poliuretano interior y PVC exterior con hilo textil de poliéster. Muy ligero y muy flexible incluso a bajas temperaturas. Elevada resistencia a la abrasión y a la flexión. Resistente a agentes atmosféricos
Aplicaciones	Aire comprimido, útiles neumáticos, pintura a pistola, circuitos de enfriamiento, máquinas para limpiar al chorro de arena y aplicaciones donde se requiere resistencia la abrasión en general.

Technical specifications	
Colour	Inside and outside light blue.
Working temperature	-25 °C +60 °C.
Working pressure	20 bar.
Pressure breakage	See table.
Specifications	Flexible hose inside polyurethane and outside PVC with braided polyester threads reinforcement, being extremely light, it keeps high flexibility features at low temperatures too. high resistance to abrasion and flexions. resistant to atmospherical agents and to most chemicals.
Applications	For compressed air, pneumatic implement, spray painting, cooling circuit sandblasting and applications where resistance at abrasion is requested.

Los datos técnicos y gráficos no son vinculantes. - Drawing and technical date are not binding.

PRESENTACIÓN EN ROLLOS DE 25 Y 100 M.	Ø TUBO EXT X INT (MM)	PRESIÓN DE ROTURA (BAR)	PRESENTACIÓN	REFERENCIA
COLOR AZUL CLARO	10 x 6	70	Rollo de 25 m.	TUBFLEX06/25
			Rollo de 100 m.	TUBFLEX06/100
	12 x 8	75	Rollo de 25 m.	TUBFLEX08/25
			Rollo de 100 m.	TUBFLEX08/100
	14,5 x 10	70	Rollo de 25 m.	TUBFLEX10/25
			Rollo de 100 m.	TUBFLEX10/100



NUEVO
TUBERÍA POLIURETANO ANTIABRASIVO - ANTIABRASIVE POLYURETHANE HOSE

Datos Técnicos	
Color	Azul.
Temperatura de trabajo	de -35°C hasta 80°C
Presión de trabajo	20 bar.
Características	Alta resistencia a la abrasión y al aplastamiento
	Reforzada con fibra de poliéster.
	Dureza: 57 Shore A.
Aplicaciones	Aire comprimido.

Technical specifications	
Colour	Blue.
Working temperature	From -35°C to 80°C
Working pressure	20 bar.
Specifications	High resistance to abrasion and crushing
	Fiber reinforced polyester
	Hardness: 57 Shore A
Applications	Compressed air

Los datos técnicos y gráficos no son vinculantes. - Drawing and technical data are not binding.

Ø TUBO EXT X INT (MM)	RADIO MÍNIMO DE CURVATURA (MM)	PRESENTACIÓN	REFERENCIA
12x 8	30	Rollo de 50 m.	TUBEX-08
15 x 10	35	Rollo de 50 m.	TUBEX-10



TUBERÍA ANTIESTÁTICA - ANTISTATIC TUBE

Datos Técnicos	
Color	Negro con grabación en color blanco.
Temperatura de trabajo	Hasta 80 °C. Consultar con Departamento Técnico.
Presión de trabajo	De 9 a 15 bar, según diámetros.
Características	Cumple con los requisitos de la Directiva Europea ATEX 94/9/EC.
	Tubería especial de poliuretano para aplicaciones donde es importante prevenir las cargas estáticas.
	Diámetro exterior calibrado. Adaptada para aplicaciones con racores automáticos metálicos.
	Alta protección antiestática con una resistividad mayor o igual a 104 ohmios.
	Resistente a la acción de los microbios y a la hidrólisis.
	Mínimo radio de curvatura.
	Densidad: 1,18 gr / cm ³
	Dureza: 52 Shore D.
	Muy buena resistencia a los rayos UVA
	Gran rentabilidad debido a su larga vida útil.
Aplicaciones	Neumática en general y aplicaciones para vacío.
	Puede ser usada en el sector de producción de componentes electrónicos, en áreas con riesgo de explosión, industria minera, para recubrimiento y separación de componentes, etc.

Technical specifications	
Colour	Tubing colour black, marking colour white.
Working temperature	Up to 80 °C. check with our technical department.
Working pressure	From 9 bar to 15 bar, according to diameters.
Specifications	Special polyurethane tubing for all applications where static charging must be prevented.
	Calibrated outside diameter, fits all conventional plug-ins made of metal.
	High antistatic protection with surface resistivity bigger or equal than 104 ohms.
	Resistant to hydrolysis and microbes.
	Minimum bend radius.
	Density: 1,18 gr / cm ³
	Hardness: 52 Shore D.
	Very good UV resistance.
	Favourable cost due to long service life.
	Can be employed as pneumatic tubing.
Applications	Suitable for vacuum applications.
	Used for manufacturing electronics components, in the coating industry, in explosion proof areas, in mining or for covering and sorting components

Los datos técnicos y gráficos no son vinculantes. - Drawing and technical data are not binding.

PRESENTACIÓN EN ROLLOS DE 50 / 100 M. Y DISPENSADORES DE 25 M.
DISPONIBLE EN VARIOS COLORES. VER TABLA

Ø TUBO D X D (MM)	REFERENCIA ESPESOR E (MM)	PRESIÓN DE TRABAJO A 20 °C (BAR)	PRESIÓN DE ESTALLIDO A 20 °C (BAR)	RADIO MÍNIMO CURVATURA R (MM)	PESO (GR / ML)	PRESENTACIÓN	REFERENCIA ROLLOS DE 100 M.
4 x 2,5	DPUA0425-NE	0,75	15	44	9	9,04	Dispensador de 25 m.
	PUA0425-NE						Rollo de 50 m.
6 x 3,9	DPUA0639-NE	1,05	14	40	15	19,28	Dispensador de 25 m.
	PUA0639-NE						Rollo de 50 m.
8 x 5,7	DPUA0857-NE	1,15	10	30	28	29,22	Dispensador de 25 m.
	PUA0857-NE						Rollo de 50 m.
10 x 7,5	DPUA1075-NE	1,25	9	27	35	40,58	Dispensador de 25 m.
	PUA1075-NE						Rollo de 50 m.

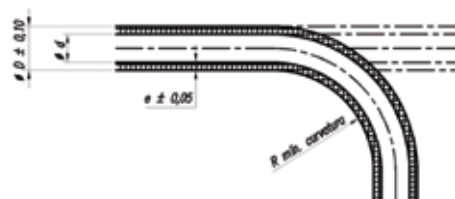

TUBERÍA AUTOAJUSTABLE AS - AS SELF FASTENING TUBE

Datos Técnicos	
Color	Azul, rojo y verde.
Temperatura de trabajo	Aire -25 °C +70 °C / Agua +10 °C +70 °C.
Presión de trabajo	Diámetros 1/4"-3/8"-1/2" 18 bar / Diámetro 3/4" - 16 bar.
Presión de rotura	4 veces la presión de trabajo.
Características	Excelente resistencia al ozono, abrasión y ambientes agresivos (chispas, hidrocarburos, rayos UVA, etc). Fácil ensamblaje.
	Puede ser montado sin anillos tuercas ni abrazaderas. Exento de siliconas.
Aplicaciones	Recomendado para aceites hidráulicos a base de petróleo, soluciones anticongelantes, agua, aire y aceite lubricante caliente.
	Está adaptado para máquinas de lavado a baja presión, sistemas neumáticos y circuitos de retorno.
	El uso de este tubo no está recomendado para altas presiones o aplicaciones críticas.

Technical specifications	
Color	Red, green and blue.
Working temperatura	Air -25 °C + 70 °C / water +10 °C + 70 °C.
Working pressure	1/4"-3/8"-1/2" 18 bar / 3/4" - 16 bar.
Pressure breakage	4 times working pressure.
Specifications	AS self fastening tube has a good resistance to abrasion, to aggressive environments (sparkles. UV, hydrocarbons) and to ozone.
	Easy assembling. It can be mounted without rings, nuts or fastening clamps. Silicon free.
Applications	It's recommended for hydraulic oils on petrol basis, antifreeze solutions, water, hot lube oils and air.
	It's suitable for washing machines and low pressure circuits, pneumatic systems and return circuits.
	The use of self fastening tube is not recommended in high pressure or critical applications

Los datos técnicos y gráficos no son vinculantes. - Drawing and technical date are not binding.

PRESENTACIÓN EN ROLLOS DE 40 M.	REFERENCIA	COLOR	Ø TUBO EXT X INT (MM)	RADIO MÍNIMO DE CURVATURA (MM)	PESO APROXIMADO (GRS / M)
		AS 1/4-AZ	Azul	13 x 6,3	65
AS 1/4-RO		Rojo			
AS 1/4-VE		Verde			
AS 3/8-AZ		Azul	16 x 9,5	75	192,5
AS 3/8-RO		Rojo			
AS 3/8-VE		Verde			
AS 1/2-AZ		Azul	19 x 12,7	125	255,0
AS 1/2-RO		Rojo			
AS 1/2-VE		Verde			
AS 3/4-AZ		Azul	27 x 19,1	175	404,2
AS 3/4-RO		Rojo			
AS 3/4-VE		Verde			

NUEVO
TUBERÍA AUTOAJUSTABLE AS PARA ROBÓTICA
AS SELF FASTENING TUBE FOR ROBOTICS

Datos Técnicos	
Color	Azul, negro, rojo y verde.
Temperatura de trabajo	-20 °C +80 °C
Características	Reforzada con fibra de poliéster. Flexibilidad de la primera capa dureza SHORE A 87, de la segunda capa dureza SHORE A 57.
	Alta resistencia a la abrasión, al aplastamiento y al ozono.
	Exento de siliconas.
Aplicaciones	Robótica industrial.

Technical specifications	
Colour	red, black, green and blue.
Working temperatura	-20 °C +80 °C
Specifications	fiber reinforced polyester. Flexibility of the first layer 87 SHORE A hardness of the second layer 57 SHORE A hardness.
	High resistance to abrasion, crushing and ozone.
	Silicon free.
Applications	Industrial welding.

Los datos técnicos y gráficos no son vinculantes. - Drawing and technical date are not binding.



Ø TUBO EXT X INT (MM)	RADIO MÍNIMO DE CURVATURA (MM)	PRESIÓN DE TRABAJO A 20°C(BAR)	PRESENTACIÓN	REFERENCIA
12,5x6,3	25	25	Rollo de 100 m.	ASR12563
16x9,5	50	20	Rollo de 100 m.	ASR1695
19x12,7	75	20	Rollo de 100 m.	ASR19127
23x16	120	17	Rollo de 50 m.	ASR2316
27x19	150	17	Rollo de 50 m.	ASR2719

Añadir al final de la referencia azul "-AZ", negro "-NE", rojo "-RG" y verde "-VE"

RACORES PARA TUBERÍA AUTOAJUSTABLE
AS STEEL BARB CONNECTORS FOR SELF FASTENING TUBES

Racor directo espiga-rosca hembra cilíndrica BSPP con asiento a 60° en acero galvanizado
 Steel straight female ogival seat 60° BSPP thread for self fastening tube

REFERENCIA	RACOR PARATUBO	ROSCA HEMBRA BSPP	Ø EXTERIOR ESPIGA	HEXÁGONO (E/C MM)	LONGITUD
3470TR14	AS 1/4	G 1/4"	9,00	19	37,2
3470TR38	AS 3/8	G 3/8"	11,70	20	44,2
3470TR12	AS 1/2	G 1/2"	15,00	27	51,5
3470TR34	AS 3/4	G 3/4"	21,40	32	68,2



Curva a 45° espiga-rosca hembra cilíndrica BSPP con asiento a 60° en acero galvanizado
 Steel elbow 45° ogival 60° seat welded BSPP thread for self fastening tube

REFERENCIA	RACOR PARATUBO	ROSCA HEMBRA BSPP	Ø EXTERIOR ESPIGA	HEXÁGONO (E/C MM)
3471TR14	AS 1/4	G 1/4"	9,00	19
3471TR38	AS 3/8	G 3/8"	11,70	22
3471TR12	AS 1/2	G 1/2"	15,00	27
3471TR34	AS 3/4	G 3/4"	21,40	32



Curva 90° espiga-rosca hembra cilíndrica BSPP con asiento a 60° en acero galvanizado
 Steel elbow 90° ogival 60° seat welded BSPP thread for self fastening tube

REFERENCIA	RACOR PARATUBO	ROSCA HEMBRA BSPP	Ø EXTERIOR ESPIGA	HEXÁGONO (E/C MM)
3472TR14	AS 1/4	G 1/4"	9,00	19
3472TR38	AS 3/8	G 3/8"	11,70	22
3472TR12	AS 1/2	G 1/2"	15,00	27
3472TR34	AS 3/4	G 3/4"	21,40	32



Machón cónico BSPT - cilíndrico BSPP con asiento a 60° en acero galvanizado
 Steel straight adapter BSPT / BSPP thread with ogival seat for self fastening tube

REFERENCIA	ROSCA BSPT (MACHO CÓNICA)	ROSCA BSPP (MACHO CILÍND.)	HEXÁGONO (E/C MM)	LONGITUD
3474TR14	R 1/4"	G 1/4"	19	33,0
3474TR38	R 3/8"	G 3/8"	22	39,0
3474TR12	R 1/2"	G 1/2"	27	43,0
3474TR34	R 3/4"	G 3/4"	32	46,5

NUEVO

Racor directo espiga-rosca macho cilíndrica BSPP en latón amarillo
 Yellow brass male BSPP thread for self fastening tube

REFERENCIA	RACOR PARATUBO	ROSCA MACHO BSPP	Ø EXTERIOR ESPIGA	LONGITUD
3467TR1814	AS 1/4	G 1/8"	6,3	31,5
3467TR1414	AS 1/4	G 1/4"	6,3	35
3467TR1438	AS 3/8	G 1/4"	9,5	39,1
3467TR3838	AS 3/8	G 3/8"	9,5	42,5
3467TR3812	AS 1/2	G 3/8"	12,7	46,5
3467TR1212	AS 1/2	G 1/2"	12,7	48,5
3467TR1258	AS 5/8	G 1/2"	15,9	56,5
3467TR3458	AS 5/8	G 3/4"	15,9	58,5
3467TR3434	AS 3/4	G 3/4"	19,1	65,3

NUEVO

Racor directo espiga-rosca hembra cilíndrica BSPP en latón amarillo
 Yellow brass female BSPP thread for self fastening tube

REFERENCIA	RACOR PARATUBO	ROSCA HEMBRA BSPP	Ø EXTERIOR ESPIGA	HEXÁGONO (E/C MM)	LONGITUD
3468TRM1014	AS 1/4	M10x1	6,3	13	33,5
3468TRM1214	AS 1/4	M12x1	6,3	14	34,5
3468TRM1614	AS 1/4	M16x1,5	6,3	19	35,8
3468TRM1638	AS 3/8	M16x1,5	9,5	19	39,3
3468TRM2038	AS 3/8	M20x1,5	9,5	24	39,3
3468TRM2012	AS 1/2	M20x1,5	12,7	24	44
3468TRM2212	AS 1/2	M22x1,5	12,7	27	45
3468TRM2412	AS 1/2	M24x1,5	12,7	30	47
3468TRM2458	AS 5/8	M24x1,5	15,9	30	58,5
3468TRM3034	AS 3/4	M30x1,5	19,1	36	62

TUBERÍA DE POLIURETANO ANTICHISPAS DIN 5510-2 ANTISPARKLING POLYURETHANE TUBE DIN 5510-2

Datos Técnicos

El tubo de poliuretano PUKS esta producido con polímeros a base de poliéster y está indicado para todas las aplicaciones en donde sea necesario utilizar materiales resistentes al fuego como, por ejemplo, en aeronaves, material ferroviario, robots de soldadura, aplicaciones en edificios, etc. Especialmente indicado para aplicaciones con racor instantáneo que garantiza una fácil y rápida instalación.
El tubo PUKS se puede utilizar con aire comprimido, agua o gases. Presión de trabajo: desde -0,95 / 8 bar (dependiendo de la temperatura).

Ventajas del producto

Retardante de la llama sin halógenos, autoextingente en caso de incendio. Clasificación de resistencia al fuego realizada por Underwriters Laboratories Inc®: listado UL 94 de V2 a V0.
Reducción de costes debido a su larga duración.
Válido para aplicaciones con racores instantáneos metálicos o plásticos compatibles.
Resistente a microbios y a la hidrólisis.
Alta resistencia química (resistente a la mayor parte de detergentes, disolventes y fluidos).
Pequeño radio de curvatura.
Excentente resistencia a los rayos UV.
Máxima resistencia a la abrasión y arrastre.
Indicado para aplicaciones de vacío.
Fácilmente reciclable al final de la vida útil.
Utilizado en la industria aeronáutica internacional.
Utilizado en la industria ferroviaria alemana, responde a los estándares relativos a la protección del fuego según norma alemana DIN 5510-2 y norma francesa NF16-101.

Producto conforme a la directiva 2002/95/EC **RoHS**

Technical specifications

PUKS is a special tube made of polyurethane (PUR) for all applications in the areas where flame retarded material is mandatory, as aircraft, building services engineering or railed vehicles. Is usable with push-in fittings. This ensures an easy and quick installation. Suitable for air, water and other liquid or gaseous medium. working pressure: -0,95 / 8 bar (depending on temperature)

Product advantages

Flame retarded without halogen, self-extinguishing in case of fire fire classification by Underwriters Laboratories Inc.®: listed UL 9
From V2 to V0.
Fower costs due to long durability.
Suitable for all common instant plug-in connectors made out of metal or suitable plastics.
Resistant against microbes and hydrolyses.
High chemical resistance (most detergents, solvents and other contact media).
Small bend radius.
Excellent UV resistance.
Top resistance to abrasion and scrubbing (suitable for drag chains).
Suitable for vacuum applications.
Recyclable (basic material could be reused), disposal permission as industrial waste similar to domestic waste.
Released to the international aircraft construction.
Released to German railway, corresponding standards regarding railway fire protection DIN 5510-2 (German Standard) and NF16-101 (French Standard).

Products in conformity with the directive 2002/95/EC **RoHS**

Los datos técnicos y gráficos no son vinculantes. - Drawing and technical date are not binding.

PRESENTACIÓN EN ROLLOS DE 50 M.	Ø TUBO EXT X INT (MM)	REFERENCIA TOLERANCIA (MM)	RADIO DE CURVATURA MÍNIMO (MM)	PRESIÓN DE TRABAJO (BAR)	PESO APROXIMADO (GRS/ML)	Peso Weight(g/m)
COLOR AZUL	6 x 4	PUKS 0604AZ	± 0,10	14	37	19,95
	8 x 5,7	PUKS 0857AZ	± 0,10	28	32	31,43
	10 x 7,5	PUKS 1075AZ	-0,10 +0,15	38	28	43,64
	12 x 9	PUKS 1209AZ	-0,10 +0,15	45	30	62,84
	14 x 10	PUKS 1410AZ	± 0,15	45	38	95,76
	16 x 11	PUKS 1611AZ	± 0,15	55	27	134,66



ENROLLADORES AUTOMÁTICOS SERIE 500 - SERIE 500 AUTOMATIC REELS

Datos Técnicos
Características
Carenado fabricado en aluminio con recubrimiento epoxy de color azul.
Manguera de servicio de PVC con refuerzo textil con terminal prensado con muelle de protección.
Presión máxima de trabajo: 20 bar.
Recogida automática de la manguera.
Soporte metálico de anclaje pivotante.
Incluye manguera de acometida de PVC con refuerzo textil de 60 cms. de longitud (sin racor).
Incluye Declaración C.E. de Conformidad para máquinas según Directiva 2006/42/CE.
Indicados para trabajar a la intemperie, la carena protege la manguera de la acción solar.
Diseño compacto de reducidas dimensiones
Aplicaciones
Indicados para la conducción de aire comprimido, nitrógeno y agua.
Su utilización ayuda a mejorar el entorno y ergonomía del puesto de trabajo.
Gran resistencia a la corrosión.

Technical specifications
Features
Fairing made of aluminum with epoxy coating blue.
Service PVC hose with textile reinforcement pressing spring capping.
Maximum working pressure: 20 bar.
Automatic collection hose.
Metal bracket pivotally anchor.
Includes PVC inlet hose with textile reinforcement 60 cms. length (without fitting).
Includes Declaration C.E. of Conformity for machines to Directive 2006/42 / EC.
Suitable for working outdoors, the hull protects the hose from solar action.
Compact design with small footprint.
Applications
Indicated for conducting compressed air, nitrogen and water.
Its use helps to improve the environment and workplace ergonomics.
High resistance to corrosion.

Los datos técnicos y gráficos no son vinculantes. - Drawing and technical date are not binding.



REFERENCIA	ROSCA TUBO DE SERVICIO	TUBERÍA (ext. / int.)	LONGITUD DE MANGUERA (m)
500117.15-8	Racor rosca macho R 1/4"	Diámetro exterior 12 mm. Diámetro interior 8 mm. (5/16")	15
500118.12-10	Racor rosca macho R 3/8"	Diámetro exterior 14 mm.	12

ENROLLADORES AUTOMÁTICOS - AUTOMATIC REELS

Datos Técnicos
Características
Carcasa azul antiimpactos fabricada en polipropileno de gran calidad.
Tubería de PVC con refuerzo textil (EN-0808 negra y EN1015 amarilla).
Incorpora tramo de manguera de entrada para permitir una cómoda conexión a la red.
Soporte metálico orientable 180°.
Sistema automático de retención de manguera a la longitud deseada. Presión nominal: 20 bar.
Aplicaciones
Aire comprimido y agua.

Technical specifications
Features
Sem blue Casing made of high quality polypropylene.
PVC pipe with textile reinforcement (EN-0808 black and yellow EN1015).
Incorporates inlet hose section to allow convenient connection to the network.
Adjustable metal bracket 180.
Automatic retention hose to the desired length. Nominal pressure: 20 bar.
Applications
Compressed Air and water

Los datos técnicos y gráficos no son vinculantes. - Drawing and technical date are not binding.



REFERENCIA	DIMENSIONES APROXIMADAS (LARGO X ALTO X ANCHO) (MM.)	ROSCA DE ENTRADA Y SALIDA	DIÁMETRO INT. MANGUERA (mm)	LONGITUD DE MANGUERA (m)
EN-0808	346 x 311 x 161	Macho R 1/4"	8	8
EN-1015	445 x 400 x 220	Macho R 3/8"	10	15

ENROLLADOR DE MANGUERA PORTÁTIL - PORTABLE HOSE REEL

Datos Técnicos

Ventajas del producto

Carcasa color negro.

Tubería amarilla de PU/PVC con refuerzo textil.

Incorpora tramo de manguera de entrada para permitir una cómoda conexión a la red. Además de su condición de portátil, se suministra con un pequeño soporte metálico que permite su sujeción a la pared.

Sistema automático de retención de manguera a la longitud deseada. Presión nominal 20 bar.

Aplicaciones

Aire comprimido, obras, servicios técnicos, etc. y, en general, cualquier aplicación que requiera el transporte de compresores y maquinaria.

Technical specifications

Product advantages

Housing black color.

Yellow Pipe PU / PVC with textile reinforcement.

Incorporates inlet hose section to allow convenient connection to the network. In addition to its status as laptop, is supplied with a small metal bracket that allows attachment to the wall.

Automatic retention hose to the desired length. Nominal pressure 20 bar.

Applications

Compressed air, works, technical services, etc. and generally, any application requiring compressors and transport machinery.

Los datos técnicos y gráficos no son vinculantes. - Drawing and technical date are not binding.



REFERENCIA	DIMENSIONES APROXIMADAS (LARGO X ALTO X ANCHO) (MM.)	ROSCA DE ENTRADA Y SALIDA	DIÁMETRO INT. MANGUERA (mm)	LONGITUD DE MANGUERA (m)
ENPOR20B914	304 x 341 x 127	Macho R 1/4"	6,4	9

ENROLLADOR DE MANGUERA PORTÁTIL - METAL HOSE REEL

Datos Técnicos

Ventajas del producto

Tambor metálico abierto de color azul.

Tubería de caucho con refuerzo textil.

Sistema automático de retención de manguera a la longitud deseada. Se puede instalar indistintamente en techo, pared o suelo. Opcionalmente, se puede suministrar soporte giratorio para pared.

Presión nominal 20 bar.

Aplicaciones

Aire comprimido, especialmente diseñado para talleres de maquinaria de obra pública, camiones, autobuses, etc. Agua, uso industrial

Technical specifications

Product advantages

Metal Drum open blue.

Rubber tubing with textile reinforcement.

Automatic retention hose to the desired length. It can be installed either ceiling, wall or floor. Optionally, can be supplied swivel wall bracket.

Nominal pressure 20 bar.

Applications

Compressed air, workshops specially designed for public works machinery, trucks, buses, etc. Water, industrial use.

Los datos técnicos y gráficos no son vinculantes. - Drawing and technical date are not binding.



REFERENCIA	DIMENSIONES APROXIMADAS (LARGO X ALTO X ANCHO) (MM.)	ROSCA DE ENTRADA Y SALIDA	DIÁMETRO INT. MANGUERA (mm)	LONGITUD DE MANGUERA (m)
EN-1020-MA	520 x 530 x 214	Macho R 3/8"	10	20
SOP-PAR	240 x 204 x 134	---	---	---

NUEVO

KIT DE SEGURIDAD ANTIVIBRACIONES - SAFETY ANTIVIBRATION KIT

Adecuado para herramientas de aire, tales como llaves de impacto utilizadas en las industrias de mantenimiento de automóviles y grapadoras, clavadoras o trituradores de hormigón en la industria de la construcción o metalúrgica, que comúnmente causan vibraciones incesantes. La exposición a este tipo de vibraciones puede producir daños físicos permanentes comúnmente conocidos como "síndrome de los dedos blandos"; pudiendo dañar también articulaciones y músculos de la muñeca y mano.

Este KIT DE SEGURIDAD ANTIVIBRACIONES evita el desgaste mediante la absorción de golpes fuertes generados por herramientas que vibran con su uso, alargando la vida útil de la misma.

Las características de este sistema son:

- Evita la reducción drástica del caudal de aire causado por el desgaste bajo vibración continua.
- Manguera de goma flexible que permite la libertad de movimiento a la hora de trabajar. Según la normativa ISO 6150:1998 en su apartado 7.1 instalación con herramientas de choque "se recomienda insertar una manguera flexible (para aire comprimido) de longitud mínima de 300 mm entre la herramienta de choque y el acoplador rápido

Ésta manguera (referencia TUBEX) se utilizará siempre con conexiones rápidas especiales para manguera, disponible para muchas de nuestras conexiones rápidas, como por ejemplo, FLUID-10N-PM08, incluyendo nuestro perfil IMOPAC[®], con referencia CD-25N-PM08, en el caso de manguera con medidas 8 x 12 mm, y CD-25N-PM10, para medidas de 10 x 15 mm.

Disponible también para conexiones de seguridad, como por ejemplo, la referencia CD-25S-PM08.

Así, IMOPAC[®] ofrece una solución para el uso continuo o discontinuo de herramientas que produzcan vibraciones aumentando el confort y ergonomía del conjunto de la conexión, facilitando el uso de dichas herramientas.

Suitable for air tools such as impact wrenches used in the industries of automobile maintenance and staplers, nailers or concrete breakers in the construction industry or metallurgical that commonly cause incessant vibrations. Exposure to this type of vibration can lead to permanent physical damage commonly known as "soft finger syndrome"; also can damage joints and muscles of the wrist and hand.

This ANTI-VIBRATION SAFETY KIT prevents the wear by absorbing strong shocks generated by vibrating tools to use, extending the life of it.

The features of this system are:

- Avoid the drastic reduction in air flow caused by the wear under continuous vibration.
- Hose Flexible rubber that allows freedom of movement when working. According to the ISO 6150 standard: 1988 in paragraph 7.1 Installation tools shock "We recommend installing a flexible hose (compressed air) minimum length 300 mm between the tool and the quick-coupling.

This hose (TUBEX reference) will always be used with special fast hose connections available for many of our fast connections, such as 10N-FLUID-PM08, including our profile IMOPAC[®] with reference CD-25N-PM08, in case of hose with measures 8 x 12 mm, and CD-25N-PM10, for measures 10 x 15 mm.

Also available for safety connections, such as the reference CD-25S-PM08.

Thus IMOPAC[®] provides a solution to the continuous or discontinuous use of tools which generate vibrations increasing comfort and ergonomics of the connection assembly, facilitating the use of such tools.



